

Power Quality

Components for reactive power compensation

MADE IN GERMANY

Components for reactive power compensation.



Reactive power controllers

Power capacitors

Filter circuit reactors

Capacitor contactors

Thyristor switches



One System. Best Solutions.



KBR
EnergyManagement



Recording



Monitoring



Optimizing

About us Page 4

Today, energy management is crucial for a company's success and becomes increasingly important. For 40 years, more than 110 employees have been developing, manufacturing and servicing customer-driven solutions in the energy management field. As a medium-sized company we create...

MADE IN
GERMANY

About us

Reactive power compensation basics Page 11

Reactive power is the power required to create a magnetic field in inductive consumers like motors, transformers, ballasts, induction furnaces, etc., that is, coils of any design...

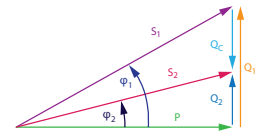

Basics

Reactive power controller Page 16

They are the main component of reactive power compensation systems. After calculating the compensation power, they automatically switch capacitor stages on or off in order to reduce the strain on electrical supply installations loaded unnecessarily by inductive reactive current.



Reactive power controllers

Power capacitors Page 26

Power capacitors for reactive current compensation in single-phase and 3-phase versions, developed for the highest requirements. Apart from a long operating life and high current and voltage load capacity, safety in case of overload (all pole internal overpressure disconnecter) is a crucial advantage...



Power capacitors

Filter circuit reactors Page 38

To prevent resonance phenomena caused by harmonic content in the power supply system, filter circuit inductors are required to set up detuned compensation systems. Here, high linearities guarantee the necessary functional stability even in the overload range.

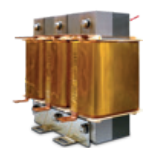

Filter circuit reactors

Capacitor contactors and thyristor switches Page 46

multiswitch low-voltage switching devices are produced and tested according to the relevant national and international rules and regulations... | With thyristor switches, you can connect and disconnect capacitors quickly and without wear and tear...



Capacitor contactors and thyristor switches

KBR system Page 58

Recording, monitoring, analyzing, optimizing and evaluating: With a perfectly coordinated range of products, KBR offers solutions for all central tasks demanded of contemporary energy management.



KBR system

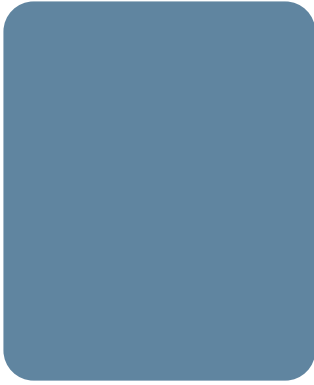

ZVEI:
Die Elektroindustrie

KBR is a member of the German association for the power capacitors branch



About KBR

Today, energy management is crucial for a company's success and becomes increasingly important. For 40 years, more than 110 employees have been developing, manufacturing and servic-

ing customer-driven solutions in the energy management field. As a medium-sized company we create innovative products and system solutions in close cooperation with our customers.





KBR is certified in accordance with ISO 9001, 14001, 50001, Authorized Economic Operator (AEO) and Secure Aviation for airfreight (LBA)

By extending its ISO 9001 quality management system by ISO 14001 environmental and ISO 50001 energy management, KBR is setting a good example.

The most important components and units for power factor correction are provided by KBR first hand. Products and solutions for contemporary energy management. Energy measurement devices and energy meters as well as the certified web-based analysis and visualization software, visual energy, help to make processes and energy consumption transparent. Based on the results, evaluations and decisions are made on possible savings in the fields of energy and resources, which consequently helps to prevent emissions.

The experts at KBR pass their experience on to their customers.



Measurement optimization technology

The basis for contemporary energy management is the precise recording and processing of energy data. With its sophisticated measuring devices, energy meters and signal components, KBR creates the best conditions for more transparency and efficiency when dealing with energy. Modular energy optimization reduces energy costs by optimizing the provision of power.

- recording measured data
- reducing load peaks
- lowering energy costs

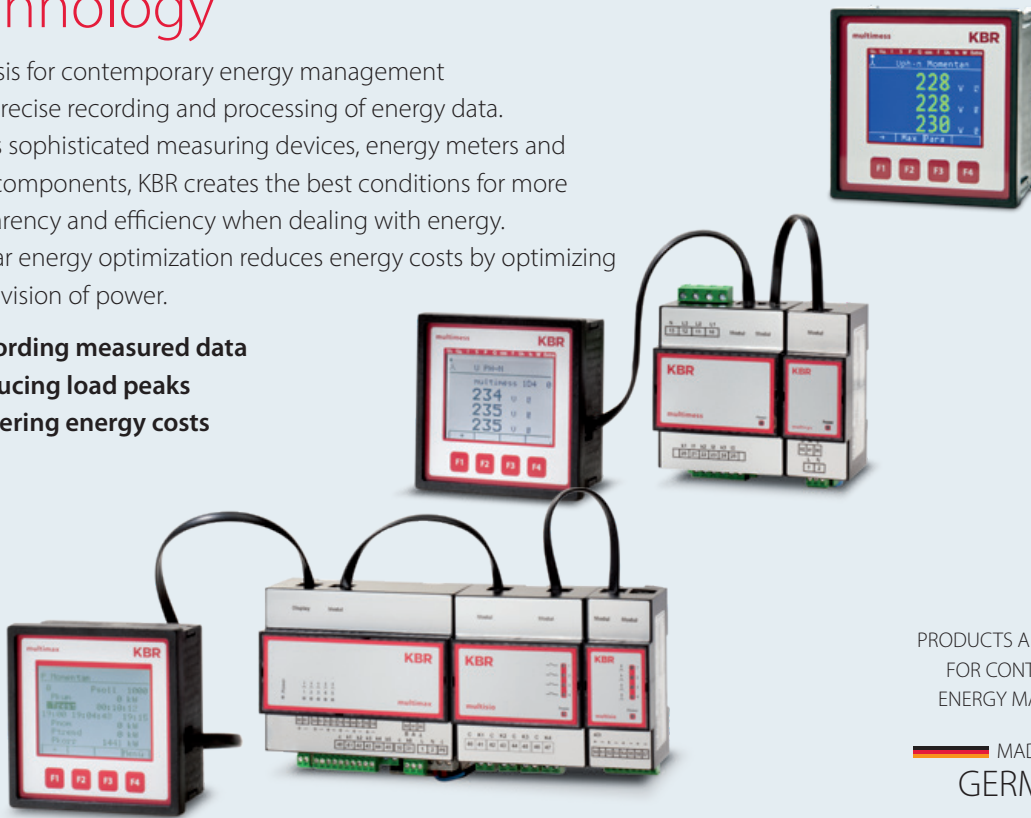

PRODUCTS AND SOLUTIONS FOR CONTEMPORARY ENERGY MANAGEMENT

MADE IN GERMANY

Software

The web-based energy data management software „visual energy“ creates a ready-to-use system with the KBR hardware and our service package. This makes the energy supply transparent, increases operating safety, helps identifying savings potentials and considerably reduces energy costs.

- analyzing energy data
- increasing operational safety
- recognizing savings potentials



visual energy
The power center for your energy management



PRODUCTS AND SOLUTIONS FOR CONTEMPORARY ENERGY MANAGEMENT

MADE IN GERMANY

Power capacitors

- power from 1.5 to 50 kvar
- capacitor rated voltage of 280, 415, 440, 480, 525, 690 or 800 V
- single-phase or 3-phase version
- high level of safety through dry technology and 3-phase internal overpressure disconnecter.
- including compact discharge resistor
- long operating life
- increase operational safety



PRODUCTS AND SOLUTIONS
FOR CONTEMPORARY
ENERGY MANAGEMENT

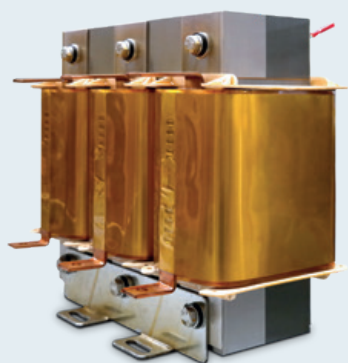

PRODUCTS AND SOLUTIONS
FOR CONTEMPORARY
ENERGY MANAGEMENT



Compensation

Reactive power compensation and improvement of the network quality are essential aspects of KBR Power Quality. KBR develops and produces the components for the compensation systems in its own production facilities. Our Power Quality team offers network analyses, on-site troubleshooting and active power filters in order to improve network quality.

- reduction of reactive energy costs
- increasing supply safety
- increasing operational safety

REACTIVE POWER COMPENSATION MADE IN GERMANY: ABOVE-AVERAGE OPERATING LIFE DUE TO...

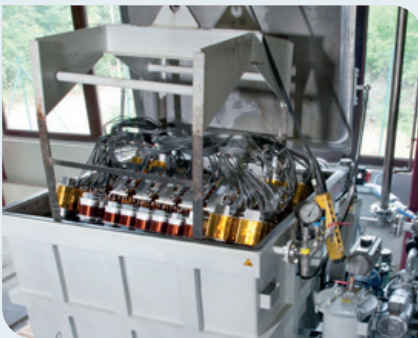

In-house development!

With its own hardware, firmware and software development, KBR is a highly flexible partner. Our customers' ideas are directly integrated in the product development.

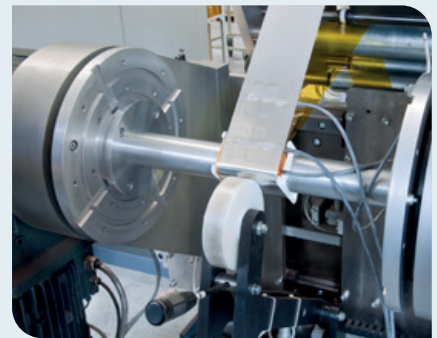

In-house production of electronic devices!

In-house reactive power controller development guarantees ideal control of reactive power.



PREMIUM QUALITY
„Made in Schwabach“
ALL FROM A SINGLE SOURCE.

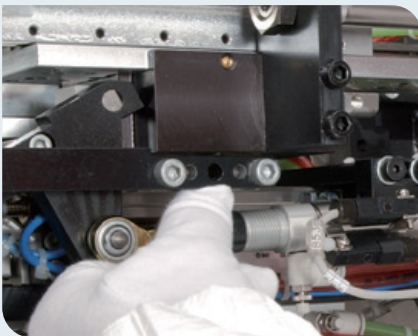

In-house production of power capacitors!

We also produce the most important component ourselves: Power capacitors of the highest quality with high current-carrying capacity and a long operating life.



In-house production of filter circuit reactors!

The filter circuit reactors needed for the detuned reactive current compensation systems are developed and produced in-house.

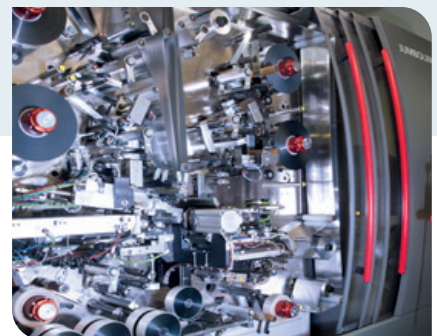

The issues of “lowering energy costs” and “network quality” are becoming ever more relevant. The use of compensation and energy control systems does not only reduce costs but also the load on a company's own lines and distributions.

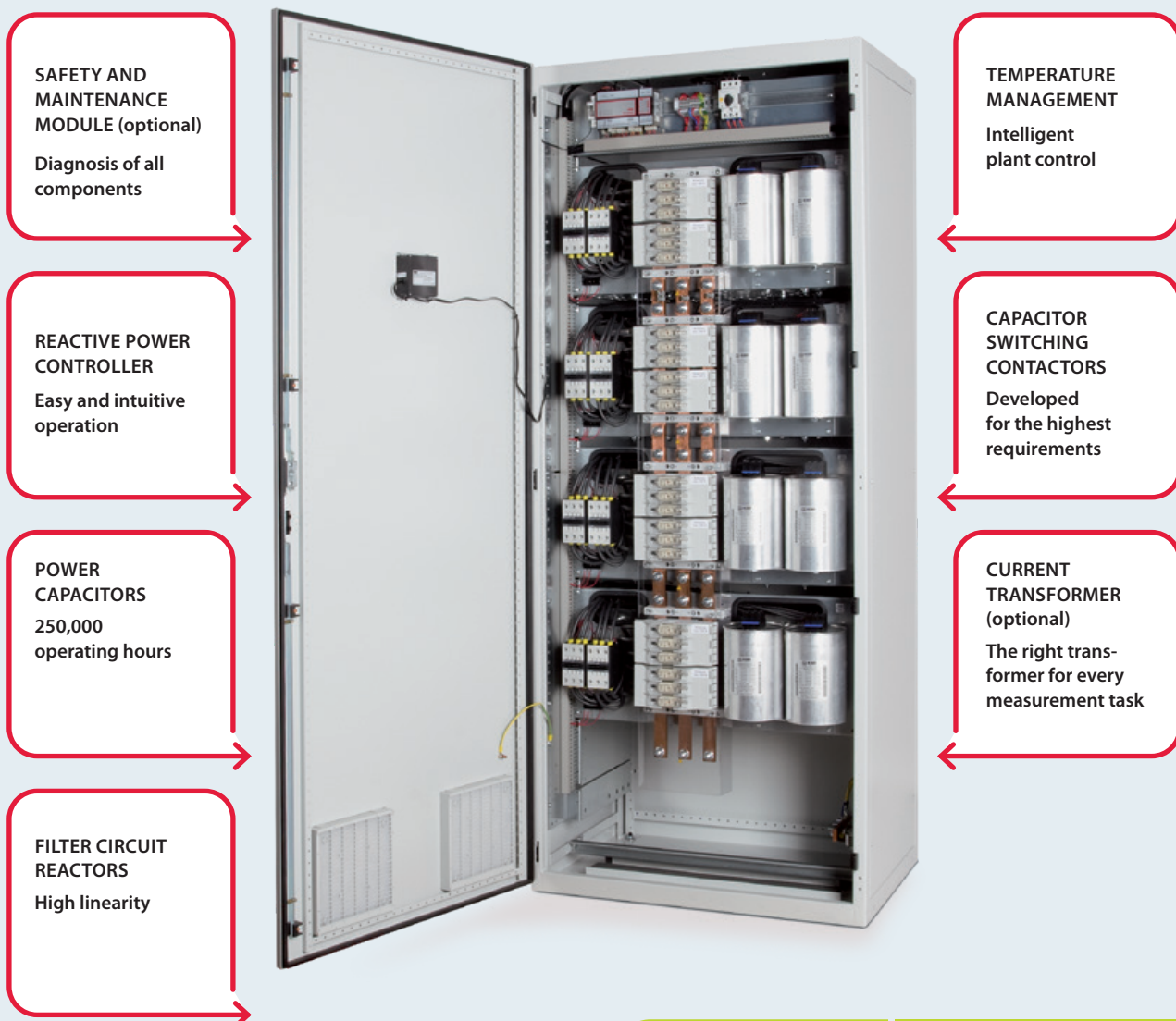

SAFETY AND MAINTENANCE MODULE (optional)
Diagnosis of all components

REACTIVE POWER CONTROLLER
Easy and intuitive operation

POWER CAPACITORS
250,000 operating hours

FILTER CIRCUIT REACTORS
High linearity

TEMPERATURE MANAGEMENT
Intelligent plant control

CAPACITOR SWITCHING CONTACTORS
Developed for the highest requirements

CURRENT TRANSFORMER (optional)
The right transformer for every measurement task

PRODUCTS AND SOLUTIONS
FOR CONTEMPORARY
ENERGY MANAGEMENT

MADE IN
GERMANY

Product advice:
+49 (0) 9122 6373-0

info@kbr.de

Need more information?

We will be happy to advise you personally.

Reactive power basics

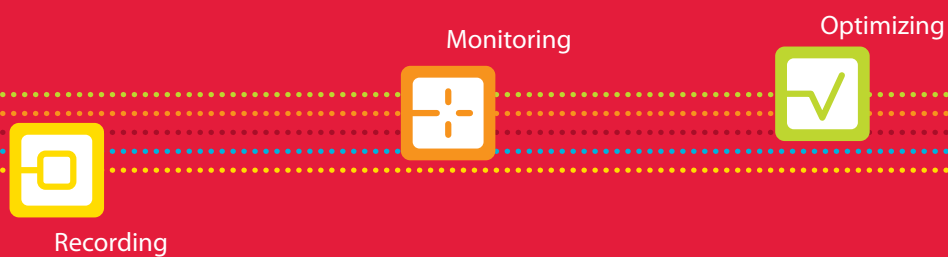

Reactive power is the power required to create a magnetic field in inductive consumers like motors, transformers, ballasts, induction furnaces, etc., that is, coils of any design.

Reactive power is also known as magnetizing power. It oscillates between the consumer and the energy provider at twice the network frequency and thus loads cables, fuses and transformers.

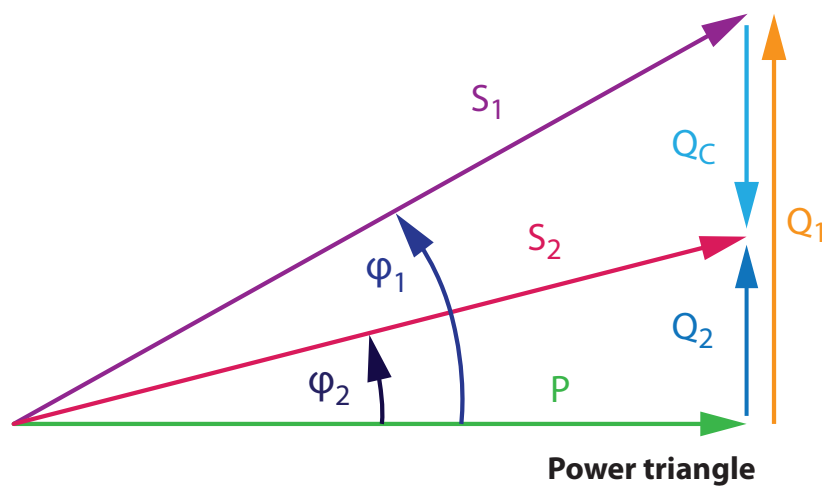

- S_1 Apparent power without compensation system
- S_2 Apparent power with compensation system
- Q_1 Reactive power without compensation system
- Q_2 Reactive power with compensation system
- Q_c Capacitor power
- P Active power
- φ_1 Uncompensated power factor
- φ_2 Compensated power factor

As can be seen from the power triangle, using a compensation system reduces the reactive current requirement (reactive energy costs) and thus the apparent power.

Reactive power basics

In practical operation, reactive current compensation in commercial and industrial power networks is an issue that often raises many questions.

For technicians, the term compensation describes the interaction between different parameters which - in the best case scenario - cancel each other out. The goal is to offset the unwanted effect of a physical parameter by counteracting it with a second parameter. In our case, we want to compensate inductive with capacitive reactive power.

Electrical energy generated by power stations or through regenerative methods is transformed into largely usable energy such as light, heat or kinetic energy, depending on the consumer. Some consumers require inductive reactive power from the energy supply network to create a magnetic field. Typical inductive consumers are motors and transformers.

The active power resulting from the product of voltage and current is billed by the energy provider as consumed energy in kWh. Things are different with reactive power. It changes between provider and consumer and is not "consumed" in the literal sense.

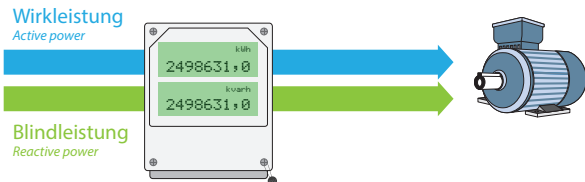

Energy transfer without compensation

Why does the energy provider bill the reactive energy?

The degree of load created by network transformers, transmission lines and power plants is expressed as apparent power (S). It is calculated from the active power (P) and reactive power (Q).

$$S = \sqrt{P^2 + Q^2}$$

As can be seen from the formula, the transmission equipment of the network operator is additionally loaded by the reactive power. To keep the current-related losses to a minimum and to guarantee economic energy transport, network operators stipulate a minimum power factor $\cos\phi$. This describes the ratio of active to apparent power.

$$\cos\phi = \frac{P}{S}$$

Energy meters for commercial and industrial use not only measure the active energy but also the reactive energy, which is billed in accordance with the electricity supply agreement. For most energy supply networks, a $\cos\phi$ of 0.9 is specified. Here,

50% of the consumed active energy obtained from the power supply network may be taken as reactive energy free of charge in the billing period.

Other reasons for reactive power compensation

Thus, the main objective of reactive power compensation is to reduce the reactive power costs billed by the energy provider to "zero."

Another reason for reactive power compensation is to reduce the current load. For this, let's take a closer look at the formula for active power:

$$P = U \times I \times \cos\phi \times \sqrt{3}$$

If we apply it to the current, this results in the following formula:

$$I = \frac{P}{U \times \cos\phi \times \sqrt{3}}$$

The current thus depends on the power factor $\cos\phi$. Let's calculate the current reduction using an example:

An additional consumer with a power consumption of 35 A is to be connected to a sub-distribution unit with 250 A at an outgoing line. The following values were measured:

$$U = 400 \text{ V}$$

$$I = 238 \text{ A}$$

$$\cos\phi = 0,72$$

$$P = U \times I \times \cos\phi \times \sqrt{3} = 400 \text{ V} \times 238 \text{ A} \times 0,72 \times \sqrt{3} = 118.700 \text{ W}$$

If you increase the power factor $\cos\phi$ to 0.97 by compensation, the current is reduced from 238 A to:

$$I = \frac{P}{U \times \cos\phi \times \sqrt{3}} = \frac{118.700 \text{ W}}{400 \text{ V} \times 0,97 \times \sqrt{3}} = 176 \text{ A}$$

By compensation of the reactive power, the current consumption was reduced by 62 A. Now, the consumer still required can be connected with 35 A.

Improving network quality

Reactive power compensation is also used for improving the network quality. In modern industrial installations, consumers

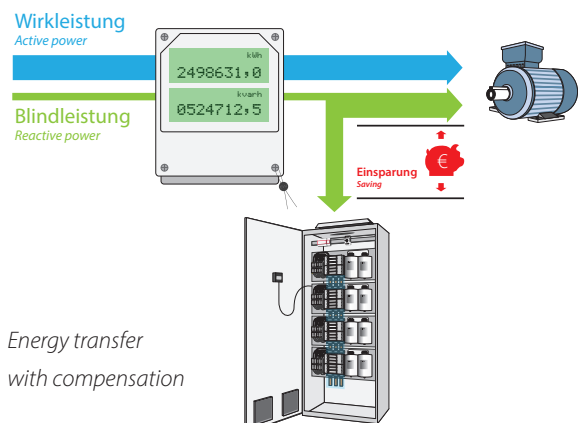

with power electronics (e.g. frequency converters) are used for energy efficiency measures. The input current of these "linear consumers" is no longer sinusoidal. As a result, network feedback is created as harmonic voltage. This can cause malfunctions in the consumers connected to the same network.

By using a compensation system as an absorption circuit, the harmonic voltage level can be reduced, rectifying the disturbance in the consumers. The principle of an absorption circuit system corresponds to that of a detuned reactive power compensation system with the resonance frequency close to the interfering harmonic frequency.

Another possible application is renewable energy generators, such as solar and wind power plants. According to applicable laws, these energy generation plants feeding energy into the public grid with an output of more than 100 kW have to contribute to keeping the voltage constant. If the network voltage drops, the voltage can be increased by switching on capacitors. A distinction is made between medium-voltage and low-voltage systems. In low-voltage systems, a Q / P characteristic curve has to be compensated, in medium-voltage systems, a Q / U characteristic curve.

Calculating the required capacitive reactive power

The capacitive reactive power is calculated using the following formula:

$$Q_c = P \times (\tan\phi_1 - \tan\phi_2)$$

Q_c = required capacitive reactive power

P = active power

$\tan\phi_1$ = tangent of the power factor $\cos\phi$ prior to compensation

$\tan\phi_2$ = tangent of the power factor $\cos\phi$ after compensation

When calculating central compensation, we do not have the necessary values as would be specified on a motor. In practice, the compensation power required is calculated using the most recent electricity bills or by taking long-term readings (network analysis).

In the electricity bill, the energy provider provides the following values on a monthly basis.

From this, the reactive power required can already be calculated using the formula introduced earlier.

$$Q = P \times (\tan\phi_1 - \tan\phi_2)$$

P = the active power specified in the electricity bill

$\tan\phi_1$ = tangent of the power factor $\cos\phi$ before compensation

$\tan\phi_2$ = tangent of the power factor $\cos\phi$ after compensation

The power factor desired is defined by the operating technician. In most cases, it is between 0.92 and 0.97 inductive. In our case, we calculate the reactive power compensation at 0.95 inductive, as is common practice.

$$Q = 498 \text{ kW} \times (0,7025 - 0,3287) = 186 \text{ kvar}$$

Active power taken from the electricity bill

$$\tan\phi_1 = \frac{\text{kvar}}{\text{kWh}} = \frac{166.023 \text{ kvar}}{(78.608 + 157.716) \text{ kWh}} = 0,7025$$

(values from the electricity bill)

$\tan\phi_2$ of the desired $\cos\phi$ 0.95

In this example, we choose the next size up for standard systems, which is 200 kvar.



Our brochure

„Reducing Energy Costs by Reactive Power Compensation“ is available for download at

www.kbr.de/dienstleistungen/download-center

Reactive power basics

Measurement-based definition of the compensation system size

The power required can also be defined by network analysis. For this purpose, a suitable measuring device is installed in the supply line of the energy provider for one week. Installation takes place without an interruption of the energy supply. The measuring device is installed while the lines are live under voltage by a trained specialist wearing protective gear.

The measured data obtained can be used not only to define the required compensation system size but also to evaluate the network quality according to DIN EN 50160.

Installing reactive power compensation

Connection to the distribution is done in a similar way as for a larger consumer. The wire cross-section and back-up fuse are defined depending on the compensation selected. In our example, the 200 kvar system consumes 288 A of current (1.44 A per kvar). 3x240/120 mm² is chosen as the wire cross-section and 400 A for the back-up fuse.

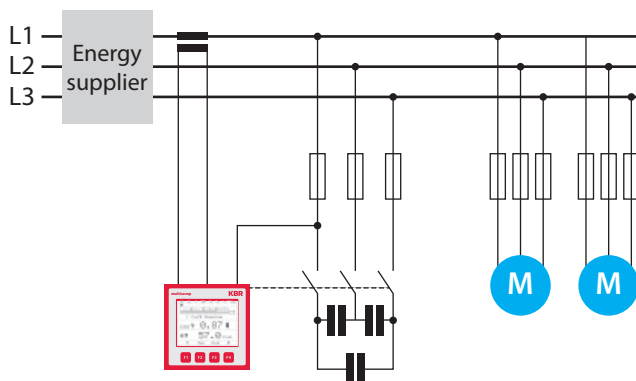

Schematic structure of a reactive power compensation system

To enable automatic control, the instantaneous $\cos\varphi$ is needed for the controller. This is determined by way of a current and voltage measurement. The controller takes the measuring voltage from the supply voltage for compensation. With a current transformer installed in the supply line to the energy provider, the controller can now calculate the reactive power required and compensate the system of the customer.

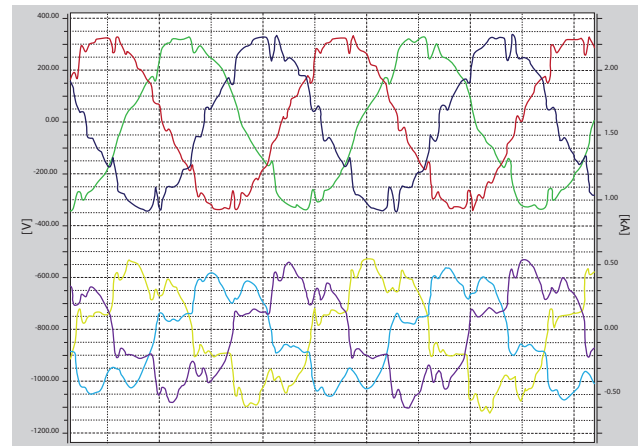

Oscilloscope image of a network measurement with superimposed harmonic voltages

Amortization

The amortization period depends on the company's operating hours. It is usually between 2 and 4 years.

Disturbances in compensation systems

Consumers have changed in recent years. Motors are for example equipped with frequency converters, electronic control gears have become standard in illumination and clocked power supply units in power electronics. The current consumption of these consumers is not sinusoidal, creating a voltage drop at the network impedances. This drop is sinusoidal but has many times the fundamental frequency. These harmonic voltages occur with frequencies of 150 Hz, 250 Hz, 350 Hz, etc. But how does a capacitor function in a network where harmonic voltage is present? The reactance X_C of a capacitor depends on the frequency.

$$X_C = \frac{1}{2 \times \pi \times f \times C}$$

Looking at the formula, it becomes clear that with higher frequencies, the reactance X_C of the capacitor decreases. What does this mean for us in practice? Depending on how much it is loaded with harmonic voltages, the amount of current a capacitor draws increases. This in turn results in a higher thermal load on the capacitor, leading to a shorter operating life. In an information brochure on the lifespan of power capacitors, the ZVEI (the German Electrical and Electronic Manufacturers' Association) states that a capacitor's lifespan is halved when the maximum temperature is exceeded by 7 °C.

Another problem in this context is the possible resonance in low-voltage networks. In this case, the reactance of the induc-

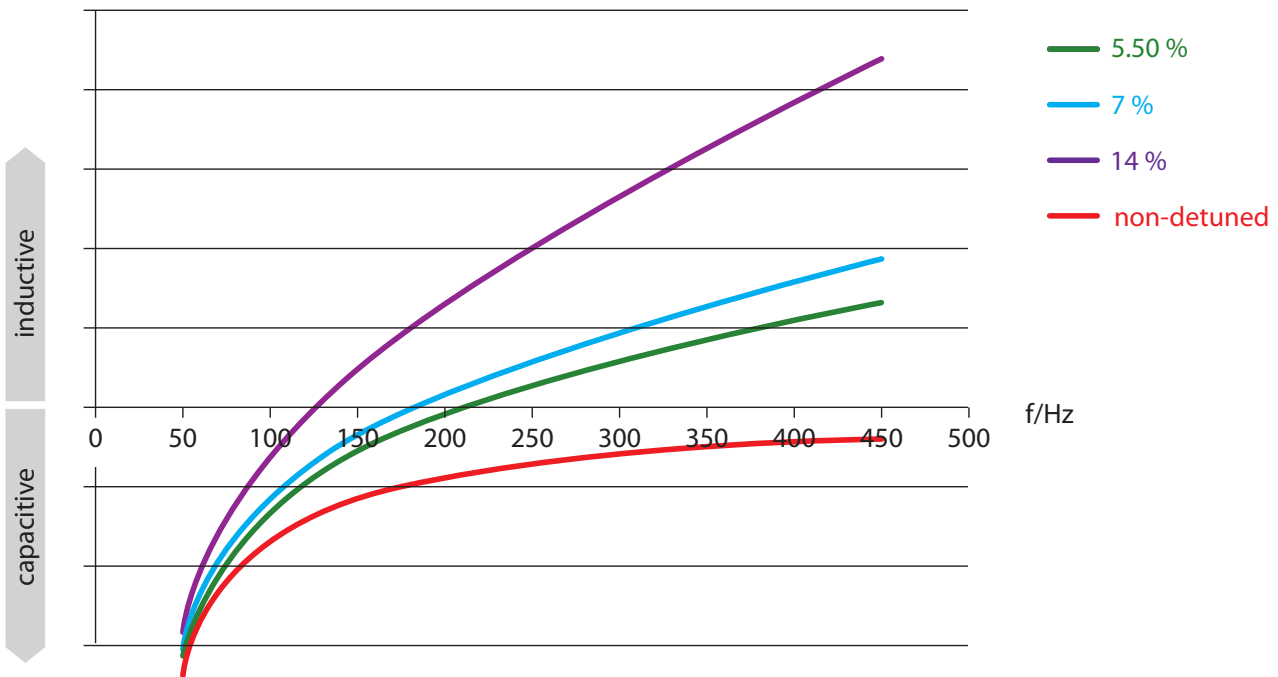

Impedance pattern of detuned compensation systems

tance and capacitance is the same at the resulting resonance frequency. The resonance frequency f_r can be calculated using the following formula:

$$f_r = \frac{1}{2 \times \pi \times \sqrt{L \times C}}$$

Detuned compensation systems

Which measures can be taken to prevent possible resonances? To deal with the continuously increasing harmonic load, detuning compensation systems have been common practice for years. But what does "detuning" mean? For detuning, each capacitor stage is set up as a series resonant circuit with an inductor connected in series.



Equivalent circuit diagram of a detuned compensation stage

The inductor connected upstream of the capacitor stage ensures a defined resonance frequency.

Common detuning factors are:

Detuning	5.5 %	7 %	12.5 %	14 %
Resulting frequency	214 Hz	189 Hz	141 Hz	134 Hz

Below the resulting detuning frequency, the capacitor stage acts like a capacitor. Above that frequency, the stage is inductive. If you set up the series resonance frequency of the detuned compensation system below the smallest possible harmonic voltage (e.g. 150 Hz, 250 Hz, 350 Hz, etc.), there are no resonances, as two inductances cannot form a resonant circuit.

Reactive power controllers

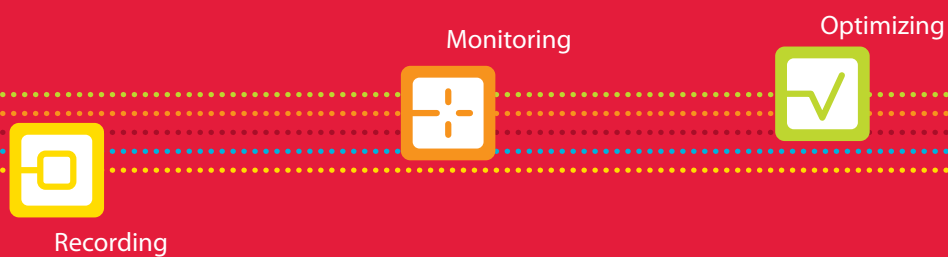

The reactive power controller is the measurement and control unit of reactive power compensation systems.

After calculating the compensation power, they automatically switch capacitor stages on or off in order to reduce the strain on electrical supply installations loaded unnecessarily by inductive or capacitive reactive current, and to reduce reactive consumption costs.



multicomp F144-3

Housing dimensions
(H x W x D in mm)

144 x 144 x 60

Data display

**LCD
illumination**

Interface

Modbus



Single-phase reactive power controller

Highlights

- Detecting and compensating for the missing compensation power in case of recovery into the energy provider network
- Rapid compensation with few switching operations
- Display with two-line LC display, stage status and recovery
- Manual-0-automatic switch separately programmable for each stage
- Integrated temperature measurement
- Interface RS485 for Modbus

An overall view of the **technical details** can be found on pages 22-25.

The microcontroller-controlled **multicomp F144-3** records all network data relevant to the control of small systems via A/D transformer inputs. After calculating the required compensation power to achieve the desired target $\cos \varphi$, the available capacitor stages are automatically switched on or off with a few switching operations. Programming is

menu-assisted and is performed with two buttons. System-specific values are stored in a non-volatile memory. Each stage can be switched individually via the built-in manual-0-automatic function.

multicomp F144-3Ph-3

Housing dimensions
(H x W x D in mm)

144 x 144 x 68

Data display

**LCD
illumination**

Interface

**KBR eBus
Modbus**



3-phase reactive power controller

- Highlights**
- Detecting and compensating for the missing compensation power in case of recovery into the energy provider network
 - 18 stages for single-phase and/or 3-phase compensation
 - Limit monitoring function for the protection of capacitors from overvoltage and excessive harmonic load
 - Integrated temperature measurement input for monitoring the ambient temperature and for switching on fans
 - Illuminated graphic display 128 x 96 pixels with dimming function

The **multicomp F144-3Ph-3** reactive power controller works automatically in 4-quadrant operation (generator operation), i.e. even during energy recovery to the energy provider network, missing compensation power is easily detected and compensated. Through the integrated temperature measurement input, the ambient temperature in the reactive power compensation system is also monitored and if a predefined

limit temperature is exceeded, the fan is switched on. The 3-phase voltage and current recording makes it possible to not only realize 3-phase compensation as before, but also single-phase compensation or a mixture of single-phase and 3-phase compensation. Of course the device has also an interface RS485 for eBus or Modbus. Available display language in DE/EN or EN/CN.

multicomp D6

Housing dimensions (H x W x D in mm)	96 x 96 x 60
Data display	LCD display illumination
Interface	KBR eBus Modbus

4-quadrant reactive power controller

- Highlights**
- Detecting and compensating for the missing compensation power in case of recovery into the energy provider network
 - Network analysis and limit value monitoring function for the protection of capacitors from overvoltage, overcurrent and excessive harmonic load.
 - Integrated temperature measurement input for monitoring the ambient temperature and for switching on fans
 - Modular up to 24 stages
 - Can be expanded by the secureC safety and maintenance module

An overview of the **technical details** is given on pages 22-25.

The **multicomp D6** reactive power controller works automatically in 4-quadrant operation (generator operation), i.e. even during energy recovery to the energy provider network, missing compensation power is easily detected and compensated. Through the integrated temperature measurement input, the ambient temperature in the reactive power compensation system is also monitored and if a predefined

limit temperature is exceeded, the fan is switched on. The multicomp F96 also has an interface for connection to the KBR eBus, whereby all settings can be conveniently carried out from the PC (without the display module). In addition, the bus communication can be switched from KBR eBus to Modbus RTU/ASCII.



multicomp F96
Display module



multisio D2-4RO
Relay module



multisio D2-1TI2RO
Temperature and fan module



multimes D4
measuring module



multisio D2-4AI
Digital input



multisio D2-4DI
digital output

Temperature management

Conventional reactive power controllers simply switch off the system when they reach a limit temperature.

The consequences: Reactive current costs, high apparent current and the triggering of switches. The temperature management can avoid this to a great extent.

- Simple connection of expansion systems thanks to ribbon and bus technology
- Minimal wiring required
- Each system cabinet can be controlled and monitored separately (control by ventilation, temperature measurement, safety shutdown)
- Can be expanded with the KBR safety concept

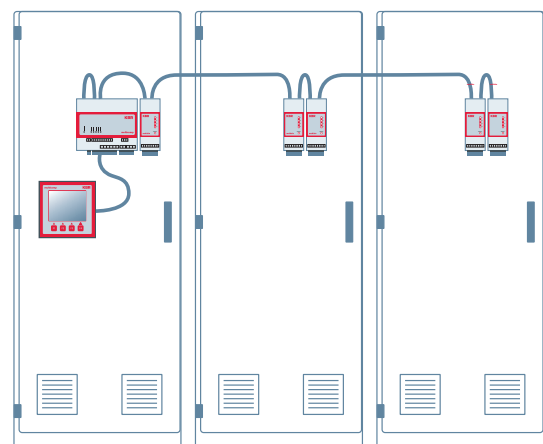
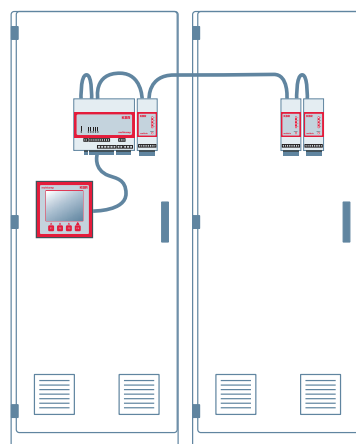
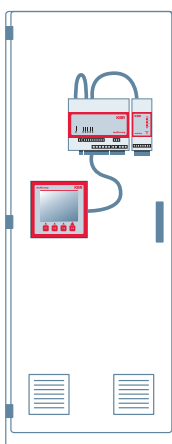

Control cabinet	Control and expansion cabinet		Control cabinet and 2 expansion cabinets		
400/16	400/8	400/4	400/8	400/4	400/4
2 x 25, 3 x 50, 2 x 100 kvar	4 x 50, 2 x 100 kvar	4 x 100 kvar	4 x 50, 2 x 100 kvar	4 x 100 kvar	4 x 100 kvar
1 x multicomp F96 1 x D2-4RO	1 x multicomp F96 1 x D2-4RO	1 x D2-4RO 1 x D2-1TI2RO	1 x multicomp F96 1 x D2-4RO	1 x D2-4RO 1 x D2-1TI2RO	1 x D2-4RO 1 x D2-1TI2RO

multicomp Technical details



DEVICE TYPE

multicomp F144-3

- [1] F144-MS-1V1C1TI6RO
- [2] F144-MS-1V1C1TI12RO
- [3] F144-MS-1V1C1TI6DO
- [4] F144-MS-1V1C1TI12DO
- [5] F144-MS-1V1C1TIDO6RO

SWITCHING STAGES	Relay outputs; 250 VA per output; 250 V AC: 50/60 Hz	[1] 6 [2] 12 [3] 6 optocoupler outputs [4] 12 optocoupler outputs [5] 6 relay and 6 optocoupler outputs
	Power per stage [kvar] programmable	0 to 999,9 kVar cap.
	Discharge times programmable	0 ... 900 sec.
	Manual-0 automatic switch Status display	■ ■
	Learning function for automatic programming by induced current measurement (requirement: transformer fitted into the cable to the compensation unit)	via main current transformer
	Rotary field and phase allocation programmable	■ ■
SWITCHING PERFORMANCE	Self-optimizing Circular switching of equal stages	■ –
	Special switching functions for	Multiple series connection
	Switch-off limit for low load operation	programmable
MONITORING FUNCTIONS	Zero-voltage trigger	■
	Overcurrent switch-off (only in connection with induced current measurement)	–
	Overvoltage switch-off	fixed
	Temperature measurement and monitoring with fan control and emergency shut-down	■
	Harmonics monitoring with alarm message and emergency shut-down additional displays	■ Voltage: KF – U, 3rd – 13th harmonic
	Error messages programmable	■
	Target cos φ monitoring; alarm if unreachable	■
	Switching operation monitoring with display per stage	■
	Controller status display (overcompensation/ undercompensation)	■
SPECIAL OPERATING MODE	Thyristor fast circuit breaker (optocoupler outputs)	[3], [4], [5]
	Single-phase compensation	–
DISPLAYS	Display type	LCD (two-line)
	Measuring parameters (RMS values RMS)	U_{PH-N} , U_{PH-PH} , $\cos \varphi$, $f_{network}$, I_{main} , S_{total} , Q_{total} , P_{total} , $Q_{total\ demand}$, temp.
	Operating time display	–
MEASUREMENT	Measurement accuracy: Voltage current power	0.5% 0.5% 1%
	Update speed	20 ms
	Single-phase measurement (4Q)	Phase-phase or phase-neutral
	3-phase measurement	–

■ Standard version – Not available



multicomp F144-3Ph-3

F144-3Ph-ESMS-3V3C1T11DI20RO

**multicomp D6,
multicomp F96-DS**

D6-ESMSBDS-1-1V1C6RO

Measuring module
multimes D4

Relay module
multio D2-4RO

Temperature and fan module
multio D2-1TI2RO

Input module 4x digital
multio D2-4AI

Input module 4x analog
multio D2-4DI

18	Modular 4 – 24	-	4	2	-	-
0 to 9999.9 kVar ind. or cap.	0 to 999.9 kVar ind. or cap.	-	-	-	-	-
10 ms to 999.99 sec.	0 ... 900 sec.	-	-	-	-	-
■ ■	■ ■	- -	- -	- -	-	-
-	in connection with multimes D4 using induced current transformers	-	-	-	-	-
■ ■	■ ■	- -	- -	- -	-	-
■ -	■ ■	- -	- -	- -	-	-
Multiple series connection	Combination filter	-	-	-	-	-
programmable	fixed	-	-	-	-	-
■	■	-	-	-	-	-
-	■ in connection with multimes D4	-	-	-	-	-
programmable	programmable	-	-	■	-	-
■ Voltage: KF – U, 3rd – 19th harmonic	■ Voltage: KF – U; 3rd – 19th harmonic	-	-	-	-	-
■	■	-	-	-	-	-
■	■	-	-	-	-	-
■	■	-	-	-	-	-
■	■	-	-	-	-	-
-	-	-	-	-	-	-
■	-	-	-	-	-	-
LCD (dot matrix 128 x 96)	LCD (dot matrix 128 x 96)	LED Status indicator				
$U_{PH-N}, U_{PH-PH}, I_{main}, \cos \varphi, f_{network}, S-P-Q, S-P-Q_{total}, Q_{total demand}, temp.$	$U_{L-N} \text{ or } U_{L-L}, \cos \varphi, f_{network}, I_{main}, I_{induced}, P_{total}, Q_{total demand}, temp.$	-	-	-	-	-
■	■	-	-	-	-	-
0.5% 0.5% 1%		-	-	-	-	-
20 ms	~ 300 ms	< 1 Sec.	-	-	-	-
Phase-neutral	Phase-phase or phase-neutral	Phase-neutral	-	-	-	-
3 x phase-neutral	-	-	-	-	-	-

multicomp Technical details



multicomp F144

DEVICE TYPE

- [1] F144-MS-1V1C1TI6RO
- [2] F144-MS-1V1C1TI12RO
- [3] F144-MS-1V1C1TI6DO
- [4] F144-MS-1V1C1TI12DO
- [5] F144-MS-1V1C1TIDO6RO

MEMORY	Long-term memory		–
PASSWORD PROTECTION	With digit code		■
INPUTS	Voltage path	Low-voltage; direct measurement	30 V ... 690 V ... 790 V AC 50/60 Hz
		Medium voltage	1 V ... 99.9 kV programmable
	Current path	Main current transformer	1 x 0.15 A ... 5 A ... 6 A AC
		Induced current transformer	–
	Frequency range	40 to 70 Hz	
	2. Target value $\cos \varphi 2$	Automatic switchover in case of energy recovery	– to $\cos \varphi = 1$
OUTPUTS	Additional relay outputs Error message relay / fan relay		Stage relay/fan relay Error message relay
INTERFACES	Serial interface with KBR eBus protocol Modbus		– Modbus RTU
POWER SUPPLY	Operating voltage		100 – 240 V \pm 10 % DC/50/60 Hz
	Frequency		50/60 Hz
	Power consumption		max. 15 VA, 9 W
DIMENSIONS	Switchboard installation	Housing (H x W x D) Switchboard cutout (H x W)	144 x 144 x 60 mm 138 x 138 mm
	DIN rail installation	Housing (H x W x D)	

***4-quadrant operation:** As energy costs are becoming increasingly important economically, more and more distributed power generation plants will be set up. During low-load periods, this can result in energy being fed back into the supply network. Therefore, all possible states concerning consumption and the provision of active and reactive power must be taken into account for the control system. For example, if asynchronous generators are used to generate energy, active power may be fed into the supply network and reactive power taken from the supply network.

multicom F144-3Ph

F144-3Ph-ESMS-3V3C1T11DI20RO

**multicom D6,
multicom F96-DS**

D6-ESMSBDS-1-1V1C6RO

Measuring module
multimes D4

Relay module
multio D2-4RO

**Temperature
and fan module**
multio D2-1T12RO

**Input module
4x digital**
multio D2-4AI

**Input module
4x analog**
multio D2-4DI

–	for events and error messages; battery-buffered with timestamp	–	–	–	–	–
■	■	–	–	–	–	–
3-phase / single-phase 25 V ... 230 V ... 280 V AC 50/60Hz	1 x 100 V ... 500 V ... 600 V AC 50/60Hz	3x 30-280 V AC, Ph-N	–	–	–	–
1 V ... 999.9 kV programmable	0.01 kV ... 30 kV programmable	–	–	–	–	–
3-phase / single-phase 0.03 A ... 5 A ... 6 A AC	1 x 0.01 A ... 1 A ... 1.2 A AC and 1 x 0.05 A ... 5 A ... 6 A AC	3x 0,02 A... 5A... 6A AC	–	–	–	–
–	via multimes D4	–	–	–	–	–
40 to 62 Hz	40 – 70 Hz	50/60 Hz	–	–	–	–
■ ■, value programmable	– automatic switchover in case of energy recovery to cos φ2, value freely programmable	– –	– –	– –	–	–
■ ■	■ ■	–	4x Stage relay	Fan relay Alarm relay	–	–
eBus, Modbus RTU	eBus Modbus RTU/ASCII	Module- bus	Module- bus	Module- bus	Module- bus	Module- bus
100 – 240 V ± 10 % DC/50/60 Hz	100 – 240 V ± 10 % DC/50/60 Hz	60-240 V ±10 % DC/50/60 Hz	24 V DC via Module- bus	24 V DC via Module- bus	24 V DC via Module- bus	24 V DC via Module- bus
50/60 Hz	50/60Hz	50/60 Hz	–	–	–	–
max. 5 - 15 VA / 9 W	15 VA	Power supply 3,2VA Module- bus 0,3 W	1 W	1,3 W	2 W	1 W
144 x 144 x 78 138 x 138 mm	96 x 96 mm, display multicom F96 LCD 92 x 92 mm, display multicom F96 LCD	–	–	–	–	–
	90 x 1068 x 61 mm, multicom D6	90 x 72 x 61 mm	90 x 36 x 61 mm	90 x 36 x 61 mm	90 x 36 x 61 mm	90 x 36 x 61 mm

Power capacitors



Power capacitors for reactive current compensation in single-phase and 3-phase versions, developed for the highest requirements. Apart from a long operating life and high current and voltage load capacity, safety in case of overload (all-pole overpressure disconnecter) is a crucial advantage of the compact dry technology components. Other features are good heat dissipation, low self-heating as well as reliable performance at high ambient temperatures.



About us

Basics

Reactive power controllers

Power capacitors

Filter circuit reactors

Capacitor contactors and thyristor switches

KBR system

multicond

rated voltage U_n	280, 440, 480, 525, 690 or 800 V
rated frequency f	50/60 Hz



Power capacitor for reactive current compensation

- Highlights**
- Power from 2.8 to 37 kvar
 - Capacitor rated voltage of 280, 415, 440, 480, 525, 690 or 800 V
 - High level of safety through dry technology and 3-phase internal overpressure disconnector
 - Including compact discharge resistor
 - Long operating life

A **construction diagram** is shown on page 35.

multicond-UHPC power capacitors stand out through their combined safety concept with a self-restoring effect and 3-phase internal overpressure disconnector. In low voltage networks, inadmissibly high voltage peaks of up to 3 times the rated voltage can occur through switching operations. If these loads lead to flashovers in the dielectric, the self-restoring effect is triggered. The capacitor remains fully functional as this happens. The 3-phase internal overpressure disconnector is triggered if the amount of gas released by the many self-restoring procedures causes a spe-

cific internal pressure. The lid of the aluminum casing bends slightly and the fuse disconnects all poles of the capacitor from the network.

Note: Depending on the network voltage and when used in detuned systems, a correspondingly higher capacitor rated voltage must be selected. Beyond this, we recommend using power capacitors of the multicond-premium series in networks with increased harmonic load.

Capacitor rated voltage: **280 V – 3-phase**

FREQUENCY	POWER ON NETWORK VOLTAGE											CURRENT ON MAX. VOLTAGE	RATED CAPACITANCE	CONSTRUCTION TYPE	TYPE	Item no.							
	220 V	230 V	280V	–	–	–	–	–	–	–	–						Hz	kvar	kvar	kvar	–	–	–
50	4.6	5.0	7.4	–	–	–	–	–	–	–	–	15.3	3 x 100.1	2 1	premium UHPC-7.4-280-3P basic UHPC-7.4-280-3P	10279 10284							
60	5.5	6.0	8.9	–	–	–	–	–	–	–	18.4												
50	6.9	7.5	11.1	–	–	–	–	–	–	–	22.9	3 x 150.2	3 2	premium UHPC-11.1-280-3P basic UHPC-11.1-280-3P	10281 10285								
60	8.2	9.0	13.3	–	–	–	–	–	–	–	27.5												
50	9.1	10.0	14.8	–	–	–	–	–	–	–	30.5	3 x 200.3	3 3	premium UHPC-14.8-280-3P basic UHPC-14.8-280-3P	10280 10286								
60	11.0	12.0	17.8	–	–	–	–	–	–	–	36.6												

Capacitor rated voltage: **415 V – 3-phase**

FREQUENCY	POWER ON NETWORK VOLTAGE											CURRENT ON MAX. VOLTAGE	RATED CAPACITANCE	CONSTRUCTION TYPE	TYPE	Item no.									
	220 V	230 V	280V	380V	400V	415V	–	–	–	–	–						Hz	kvar	kvar	kvar	kvar	kvar	kvar	–	–
50	14,1	15,4	22,8	41,9	46,4	50,0	–	–	–	–	–	65,6	3 x 308.0	5	UHPC-50.0-415-3P	23497									
60	16,9	18,4	27,3	50,3	55,7	60,0	–	–	–	–	–	78,7													

Capacitor rated voltage: **440 V – 3-phase**

FREQUENCY	POWER ON NETWORK VOLTAGE											CURRENT ON MAX. VOLTAGE	RATED CAPACITANCE	CONSTRUCTION TYPE	TYPE	Item no.									
	220 V	230 V	280V	380V	400V	415V	440V	–	–	–	–						Hz	kvar	kvar	kvar	kvar	kvar	kvar	–	–
50	0.7	0.8	1.1	2.1	2.3	2.5	2.8	–	–	–	–	4.4	3 x 15.4	4	UHPC-2.8-440-3P replaced by UHPC-4.0-525-3P	– 10516									
60	0.8	0.9	1.4	2.5	2.8	3.0	3.4	–	–	–	–	5.3													
50	1.4	1.5	2.3	4.2	4.6	5.0	5.6	–	–	–	–	8.8	3 x 30.8	4	UHPC-5.6-440-3P replaced by UHPC-8.0-525-3P	– 10517									
60	1.7	1.8	2.7	5.0	5.6	6.0	6.7	–	–	–	–	10.6													
50	2.5	2.7	4.0	7.5	8.3	8.9	10.0	–	–	–	–	13.1	3 x 54.8	1 1	premium UHPC-10.0-440-3P light UHPC-10.0-440-3P	10506 21768									
60	3.0	3.3	4.9	8.9	9.9	10.7	12.0	–	–	–	–	15.7													
50	2.8	3.1	4.5	8.4	9.3	10.0	11.2	–	–	–	–	14.7	3 x 61.4	1 1 1	premium UHPC-11.2-440-3P basic UHPC-11.2-440-3P light UHPC-11.2-440-3P	10312 10318 21776									
60	3.4	3.7	5.4	10.0	11.1	2.0	13.4	–	–	–	–	17.6													

Table continued on next page.

Measurements table on page 35

multicond

Capacitor rated voltage: **440 V – 3-phase**

FREQUENCY	POWER ON NETWORK VOLTAGE											CURRENT ON MAX. VOLTAGE	RATED CAPACITANCE	CONSTRUCTION TYPE	TYPE	Item no.
	220 V	230 V	280V	380 V	400V	415V	440V	-	-	-	-					
Hz	kvar	kvar	kvar	kvar	kvar	kvar	kvar	-	-	-	-	A	µF			
50	3.0	3.3	4.9	9.0	10.0	10.8	12.1	-	-	-	-	15.9	3 x 66.3	1	premium UHPC-12.1-440-3P	10313
60	3.6	4.0	5.9	10.8	12.0	12.9	14.5	-	-	-	-	19.1		1	basic UHPC-12.1-440-3P	10319
								-	-	-	-			1	light UHPC-12.1-440-3P	21769
50	3.5	3.9	5.7	10.5	11.7	12.5	14.1	-	-	-	-	18.5	3 x 77.3	1	premium UHPC-14.1-440-3P	10314
60	4.2	4.6	6.9	12.6	14.0	15.1	16.9	-	-	-	-	22.2		1	basic UHPC-14.1-440-3P	10320
								-	-	-	-			1	light UHPC-14.1-440-3P	21777
50	3.8	4.1	6.1	11.3	12.5	13.4	15.1	-	-	-	-	19.8	3 x 82.8	1	premium UHPC-15.1-440-3P	10315
60	4.5	5.0	7.3	13.5	15.0	16.1	18.1	-	-	-	-	23.8		1	basic UHPC-15.1-440-3P	10321
								-	-	-	-			1	light UHPC-15.1-440-3P	21778
50	4.3	4.7	6.9	12.8	14.1	15.2	17.1	-	-	-	-	22.4	3 x 93.7	2	premium UHPC-17.1-440-3P	10295
60	5.1	5.6	8.3	15.3	17.0	18.3	20.5	-	-	-	-	26.9		1	basic UHPC-17.1-440-3P	10323
								-	-	-	-			1	light UHPC-17.1-440-3P	21779
50	4.5	5.0	7.4	13.6	15.0	16.2	18.2	-	-	-	-	23.9	3 x 99.7	2	premium UHPC-18.2-440-3P	10296
60	5.5	6.0	8.8	16.3	18.0	19.4	21.8	-	-	-	-	28.7		1	basic UHPC-18.2-440-3P	10324
								-	-	-	-			1	light UHPC-18.2-440-3P	21770
50	5.0	5.5	8.1	14.9	16.5	17.8	20.0	-	-	-	-	26.2	3 x 109.6	2	premium UHPC-20.0-440-3P	10297
60	6.0	6.6	9.7	17.9	19.8	21.3	4.0	-	-	-	-	31.4		2	basic UHPC-20.0-440-3P	10325
								-	-	-	-			1	light UHPC-20.0-440-3P	21412
50	5.3	5.7	8.5	15.7	17.4	19.0	21.0	-	-	-	-	27.6	3 x 115.1	2	premium UHPC-21.0-440-3P	21422
60	6.3	6.9	10.2	18.9	20.8	22.0	25.2	-	-	-	-	33.1		2	basic UHPC-21.0-440-3P	10327
								-	-	-	-			1	light UHPC-21.0-440-3P	21413
50	5.3	5.8	8.6	15.8	17.5	18.9	21.2	-	-	-	-	27.8	3 x 116.2	2	premium UHPC-21.2-440-3P	10298
60	6.4	7.0	10.3	19.0	21.0	22.6	25.4	-	-	-	-	33.4		2	basic UHPC-21.2-440-3P	10328
								-	-	-	-			1	light UHPC-21.2-440-3P	21780
50	5.6	6.1	9.1	16.8	18.6	20.0	22.5	-	-	-	-	29.5	3 x 123.3	2	premium UHPC-22.5-440-3P	22975
60	6.7	7.4	10.9	20.1	22.3	24.0	27.0	-	-	-	-	35.4				
50	6.0	6.6	9.8	18.0	20.0	21.5	24.2	-	-	-	-	31.8	3 x 132.6	2	premium UHPC-24.2-440-3P	10299
60	7.3	7.9	11.8	21.7	24.0	25.8	29.0	-	-	-	-	38.2		2	basic UHPC-24.2-440-3P	10331
								-	-	-	-			2	light UHPC-24.2-440-3P	21772
50	6.2	6.8	10.1	18.6	20.7	22.2	25.0	-	-	-	-	32.8	3x 137.0	2	light UHPC-25.0-440-3P	21781
60	7.5	8.2	12.1	22.4	24.8	26.7	30.0	-	-	-	-	39.4				
50	6.8	7.4	11.0	20.3	22.5	24.2	27.2	-	-	-	-	35.7	3 x 149.1	3	premium UHPC-27.2-440-3P	10308
60	8.2	8.9	13.2	24.3	27.0	29.0	32.6	-	-	-	-	42.8		2	basic UHPC-27.2-440-3P	10334
								-	-	-	-			2	light UHPC-27.2-440-3P	21782
50	7.0	7.7	11.4	21.0	23.2	25.0	28.1	-	-	-	-	36.9	3 x 154.0	3	premium UHPC-28.1-440-3P	10300
60	8.4	9.2	13.7	25.2	27.9	30.0	33.7	-	-	-	-	44.3		2	basic UHPC-28.1-440-3P	10335
								-	-	-	-			2	light UHPC-28.1-440-3P	21783
50	7.6	8.3	12.3	22.6	25.0	27.0	30.3	-	-	-	-	39.8	3 x 166.1	3	premium UHPC-30.3-440-3P	10303
60	9.1	9.9	14.7	27.1	30.1	32.4	36.4	-	-	-	-	47.8		2	basic UHPC-30.3-440-3P	10336
								-	-	-	-			2	light UHPC-30.3-440-3P	21773
50	7.8	8.5	12.6	23.3	25.8	27.8	32.2	-	-	-	-	40.9	3x 171.0	2	light UHPC-31.2-440-3P	21784
60	9.4	10.2	15.2	27.9	30.9	33.3	37.4	-	-	-	-	49.1				
50	9.1	9.9	14.7	27.1	30.0	32.3	36.3	-	-	-	-	47.6	3 x 198.9	3	premium UHPC-36.3-440-3P	10305
60	10.9	11.9	17.6	32.5	36.0	38.7	43.6	-	-	-	-	57.1		3	basic UHPC-36.3-440-3P	10337
								-	-	-	-			3	light UHPC-36.3-440-3P	21774
50	10.0	10.9	16.2	29.8	33.1	35.6	40.0	-	-	-	-	52.5	3x 219.2	3	light UHPC-40.0-440-3P	21785
60	12.0	13.1	19.4	35.8	39.7	42.7	48.0	-	-	-	-	63.0				

Up to a power of 30.3 kvar, 440V capacitors are also available in single-phase version. Other capacitor powers on request.

Capacitor rated voltage: **480 V – 3-phase**

FREQUENCY	POWER ON NETWORK VOLTAGE											CURRENT ON MAX. VOLTAGE	RATED CAPACITANCE	CONSTRUCTION TYPE	TYPE	Item no.
	220 V	230 V	280 V	380 V	400 V	415 V	440 V	480 V	–	–	–					
Hz	kvar	kvar	kvar	kvar	kvar	kvar	kvar	kvar	–	–	–	A	µF			
50	2.3	2.5	3.7	6.8	7.5	8.1	9.1	10.8	–	–	–	13.0	3 x 49.7	1	premium UHPC-10.8-480-3P	10377
60	2.7	3.0	4.4	8.1	9.0	9.7	10.9	13.0	–	–	–	15.6		1	basic UHPC-10.8-480-3P	10386
									–	–	–			1	light UHPC-10.8-480-3P	21786
50	2.5	2.7	4.0	7.5	8.3	8.9	10.0	11.9	–	–	–	14.3	3 x 54.8	1	premium UHPC-11.9-480-3P	10378
60	3.0	3.3	4.9	8.9	9.9	10.7	12.0	14.3	–	–	–	17.2		1	basic UHPC-11.9-480-3P	10387
									–	–	–			1	light UHPC-11.9-480-3P	21787
50	2.6	2.9	4.3	7.8	8.7	9.3	10.5	12.5	–	–	–	15.0	3 x 57.6	1	premium UHPC-12.5-480-3P	10379
60	3.2	3.4	5.1	9.4	10.4	11.2	12.6	15.0	–	–	–	18.0		1	basic UHPC-12.5-480-3P	10388
									–	–	–			1	light UHPC-12.5-480-3P	21788
50	3.0	3.3	4.9	9.0	9.9	10.7	12.0	14.3	–	–	–	17.2	3 x 65.9	1	premium UHPC-14.3-480-3P	10380
60	3.6	3.9	5.8	10.8	11.9	12.8	14.4	17.2	–	–	–	20.6		1	basic UHPC-14.3-480-3P	10389
									–	–	–			1	light UHPC-14.3-480-3P	21789
50	3.5	3.8	5.7	10.5	11.6	12.5	14.0	16.7	–	–	–	20.1	3 x 76.9	2	premium UHPC-16.7-480-3P	10365
60	4.2	4.6	6.8	12.6	13.9	15.0	16.8	20.0	–	–	–	24.1		1	basic UHPC-16.7-480-3P	10390
									–	–	–			1	light UHPC-16.7-480-3P	21790
50	3.8	4.1	6.1	11.2	12.4	13.4	15.0	17.9	–	–	–	21.5	3 x 82.4	2	premium UHPC-17.9-480-3P	10366
60	4.5	4.9	7.3	13.5	14.9	16.1	18.0	21.5	–	–	–	25.8		1	basic UHPC-17.9-480-3P	10391
									–	–	–			1	light UHPC-17.9-480-3P	21791
50	4.4	4.8	7.1	13.0	14.4	16.0	17.5	20.8	–	–	–	25.0	3 x 95.8	2	premium UHPC-20.8-480-3P	21425
60	5.2	5.7	8.5	15.6	17.3	19.0	21.0	25.0	–	–	–	30.0		2	basic UHPC-20.8-480-3P	10392
									–	–	–			1	light UHPC-20.8-480-3P	21414
50	5.0	5.5	8.1	14.9	16.5	17.8	20.0	23.8	–	–	–	28.6	3 x 109.6	2	premium UHPC-23.8-480-3P	10367
60	6.0	6.6	9.7	17.9	19.8	21.3	24.0	28.6	–	–	–	34.3		2	basic UHPC-23.8-480-3P	10393
									–	–	–			2	light UHPC-23.8-480-3P	21792
50	5.3	5.7	8.5	15.7	17.4	18.7	21.0	25.0	–	–	–	30.1	3 x 115.1	2	premium UHPC-25.0-480-3P	10368
60	6.3	6.9	10.2	18.8	20.8	22.4	25.2	30.0	–	–	–	36.1		2	basic UHPC-25.0-480-3P	10394
									–	–	–			2	light UHPC-25.0-480-3P	21794
50	5.8	6.4	9.5	17.4	19.3	20.8	23.4	27.8	–	–	–	33.4	3 x 128.0	2	basic UHPC-27.8-480-3P	20358
60	7.0	7.7	11.3	20.9	23.2	24.9	28.0	33.4	–	–	–	40.2			light UHPC-27.8-480-3P	21795
50	6.3	6.8	10.1	18.7	20.7	22.3	25.0	29.8	–	–	–	35.8	3 x 137.2	3	premium UHPC-29.8-480-3P	10369
60	7.5	8.2	12.2	22.4	24.8	26.7	30.0	35.8	–	–	–	43.0		2	basic UHPC-29.8-480-3P	10395
									–	–	–			2	light UHPC-29.8-480-3P	21797
50	7.0	7.7	11.4	20.9	23.2	25.0	28.1	33.4	–	–	–	40.2	3 x 153.8	3	premium UHPC-33.4-480-3P	10371
60	8.4	9.2	13.6	25.1	27.8	30.0	33.7	40.1	–	–	–	48.2		3	basic UHPC-33.4-480-3P	10396
									–	–	–			2	light UHPC-33.4-480-3P	21415
50	7.5	8.2	12.1	22.4	24.8	26.7	30.0	35.7	–	–	–	42.9	3 x 164.4	3	premium UHPC-35.7-480-3P	10374
60	9.0	9.8	14.6	26.8	29.7	32.0	36.0	42.8	–	–	–	51.5		3	basic UHPC-35.7-480-3P	10397
									–	–	–			2	light UHPC-35.7-480-3P	21416

Up to a power of 33.4 kvar, 480V capacitors are also available in single-phase version.

Other capacitor powers on request.

Measurements table on page 35

multicond

Capacitor rated voltage: **525 V – 3-phase**

FREQUENCY	POWER ON NETWORK VOLTAGE											CURRENT ON MAX. VOLTAGE	RATED CAPACITANCE	CONSTRUCTION TYPE	TYPE	Item no.
	220 V	230 V	280 V	380 V	400 V	415 V	440 V	480 V	525 V	–	–					
Hz	kvar	kvar	kvar	kvar	kvar	kvar	kvar	kvar	kvar	–	–					
50	0.7	0.8	1.1	2.1	2.3	2.5	2.8	3.3	4.0	–	–	4.4				
60	0.8	0.9	1.4	2.5	2.8	3.0	3.4	4.0	4.8	–	–	5.3	3 x 15.4	4	UHPC-4.0-525-3P	10516
50	1.4	1.5	2.3	4.2	4.6	5.0	5.6	6.7	8.0	–	–	8.8				
60	1.7	1.8	2.7	5.0	5.6	6.0	6.7	8.0	9.6	–	–	10.6	3 x 30.8	4	UHPC-8.0-525-3P	10517
50	1.6	1.7	2.5	4.6	5.1	5.5	6.2	7.4	8.8	–	–	9.7				
60	1.9	2.0	3.0	5.6	6.2	6.6	7.4	8.9	10.6	–	–	11.7	3 x 34.0	1	premium UHPC-8.8-525-3P	23728
50	1.8	1.9	2.8	5.2	5.8	6.2	7.0	8.4	10.0	–	–	11.0				
60	2.1	2.3	3.4	6.3	7.0	7.5	8.4	10.0	12.8	–	–	13.2	3 x 38.5	1	premium UHPC-10.0-525-3P	10435
														1	basic UHPC-10.0-525-3P	10444
50	2.0	2.1	3.2	5.9	6.5	7.0	7.9	9.4	11.2	–	–	12.3				
60	2.4	2.6	3.8	7.0	7.8	8.4	9.4	11.2	13.4	–	–	14.7	3 x 43.1	1	premium UHPC-11.2-525-3P	23755
50	2.2	2.4	3.6	6.5	7.3	7.8	8.8	10.4	12.5	–	–	13.7				
60	2.6	2.9	4.3	7.9	8.7	9.4	10.5	12.5	15.0	–	–	16.4	3 x 48.1	1	premium UHPC-12.5-525-3P	10436
														1	basic UHPC-12.5-525-3P	10445
														1	light UHPC-12.5-525-3P	21800
50	2.3	2.5	3.7	6.8	7.5	8.1	9.1	10.9	13.0	–	–	14.3				
60	2.7	3.0	4.4	8.2	9.0	9.7	10.9	13.0	15.6	–	–	17.2	3 x 50.0	1	premium UHPC-13.0-525-3P	10437
														1	basic UHPC-13.0-525-3P	10446
														1	light UHPC-13.0-525-3P	21801
50	2.6	2.9	4.3	7.9	8.7	9.4	10.5	12.5	15.0	–	–	16.5				
60	3.2	3.5	5.1	9.4	10.4	11.2	12.6	15.0	18.0	–	–	19.8	3 x 57.7	1	premium UHPC-15.0-525-3P	10438
														1	basic UHPC-15.0-525-3P	10447
														1	light UHPC-15.0-525-3P	21802
50	3.0	3.3	4.8	8.9	9.9	10.6	11.9	14.2	17.0	–	–	18.7				
60	3.6	3.9	5.8	10.7	11.8	12.7	14.3	17.0	20.4	–	–	22.4	3 x 65.4	2	premium UHPC-17.0-525-3P	10418
														1	basic UHPC-17.0-525-3P	10448
														1	light UHPC-17.0-525-3P	21803
50	3.2	3.5	5.1	9.4	10.5	11.2	12.6	15.0	18.0	–	–	19.8				
60	3.8	4.1	6.1	11.3	12.5	13.5	15.0	18.0	21.6	–	–	23.8	3 x 69.3	2	premium UHPC-18.0-525-3P	10430
														1	basic UHPC-18.0-525-3P	10449
														1	light UHPC-18.0-525-3P	21804
50	3.3	3.6	5.4	9.9	11.0	11.9	13.3	15.9	19.0	–	–	20.9				
60	4.0	4.4	6.5	11.9	13.2	14.2	16.0	19.0	22.8	–	–	25.1	3 x 73.1	2	premium UHPC-19.0-525-3P	19867
														1	basic UHPC-19.0-525-3P	10450
														1	light UHPC-19.0-525-3P	21805
50	3.5	3.8	5.7	10.5	11.6	12.5	14.0	16.7	20.0	–	–	22.0				
60	4.2	4.6	6.8	12.6	13.9	15.0	16.9	20.1	24.0	–	–	26.4	3 x 77.0	2	premium UHPC-20.0-525-3P	10431
														2	basic UHPC-20.0-525-3P	10451
														1	light UHPC-20.0-525-3P	21417
50	3.7	4.0	6.0	11.0	12.2	13.1	14.7	17.5	21.0	–	–	23.1				
60	4.4	4.8	7.2	13.2	14.6	15.7	17.7	21.1	25.2	–	–	27.7	3 x 80.8	2	premium UHPC-21.0-525-3P	10419
														2	basic UHPC-21.0-525-3P	10452
														1	light UHPC-21.0-525-3P	21420
50	4.4	4.8	7.1	13.1	14.5	15.6	17.6	20.9	25.0	–	–	27.5				
60	5.3	5.8	8.5	15.7	17.4	18.7	21.1	25.1	30.0	–	–	33.0	3 x 96.2	2	premium UHPC-25.0-525-3P	10420
														2	basic UHPC-25.0-525-3P	10453
														2	light UHPC-25.0-525-3P	21808
50	5.3	5.8	8.5	15.7	17.4	18.7	21.1	25.1	30.0	–	–	33.0				
60	6.3	6.9	10.2	18.9	20.9	22.5	25.3	30.1	36.0	–	–	39.6	3 x 115.5	3	premium UHPC-30.0-525-3P	10421
														2	basic UHPC-30.0-525-3P	10454
														2	light UHPC-30.0-525-3P	21810
50	6.0	6.5	9.7	17.8	19.7	21.2	23.9	28.4	34.0	–	–	37.4				
60	7.2	7.8	11.6	21.4	23.7	25.5	28.7	34.1	40.8	–	–	44.9	3 x 130.9	3	premium UHPC-34.0-525-3P	21874
50	6.5	7.1	10.5	19.4	21.5	23.1	26.0	30.9	37.0	–	–	40.7				
60	7.8	8.5	12.6	23.3	25.8	27.7	31.2	37.1	44.4	–	–	48.8	3 x 142.4	3	premium UHPC-37.0-525-3P	10422
														3	basic UHPC-37.0-525-3P	10455
														2	light UHPC-37.0-525-3P	21421

Up to a power of 34.0 kvar, 525V capacitors are also available in single-phase version. Other capacitor powers on request

Capacitor rated voltage: **690 V – Basic and Premium Y-circuit**

FREQUENCY	POWER ON NETWORK VOLTAGE											CURRENT ON MAX. VOLTAGE	RATED CAPACITANCE	CONSTRUCTION TYPE	TYPE	Item no.							
	220 V	230 V	280 V	380 V	400 V	415 V	440 V	480 V	525 V	600 V	690 V						Hz	kvar	kvar	kvar	kvar	kvar	kvar
50	1.0	1.1	1.6	3.0	3.4	3.6	4.1	4.8	5.8	7.6	10.0	8.4	3 x 22.3	1	premium UHPC-10.0-690-3S	10481							
60	1.2	1.3	2.0	3.6	4.0	4.3	4.9	5.8	7.0	9.1	12.0	10.		1	basic UHPC-10.0-690-3S	10482							
50	1.3	1.4	2.1	3.8	4.2	4.5	5.1	6.1	7.2	9.5	12.5	10.5	3 x 27.9	1	premium UHPC-12.5-690-3S	10475							
60	1.5	1.7	2.5	4.6	5.0	5.4	6.1	7.3	8.7	11.3	15.0	12.6		1	basic UHPC-12.5-690-3S	10483							
50	1.5	1.7	2.5	4.5	5.0	5.4	6.1	7.3	8.7	11.3	15.0	12.6	3 x 33.4	2	premium UHPC-15.0-690-3S	10468							
60	1.8	2.0	3.0	5.5	6.0	6.5	7.3	8.7	10.4	13.6	18.0	15.1		1	basic UHPC-15.0-690-3S	10484							
50	2.0	2.2	3.3	6.1	6.7	7.2	8.1	9.7	11.6	15.1	20.0	16.7	3 x 44.6	2	premium UHPC-20.0-690-3S	10474							
60	2.4	2.7	4.0	7.3	8.1	8.7	9.8	11.6	13.9	18.1	24.0	20.1		2	basic UHPC-20.0-690-3S	10485							
50	2.1	2.3	3.4	6.3	7.0	7.5	8.5	10.1	12.1	15.7	20.8	17.4	3 x 46.4	2	premium UHPC-20.8-690-3S	10469							
60	2.5	2.8	4.1	7.6	8.4	9.0	10.2	12.1	14.5	18.9	25.0	20.9		2	basic UHPC-20.8-690-3S	10486							
50	2.5	2.8	4.1	7.6	8.4	9.0	10.2	12.1	14.5	18.9	25.0	20.9	3 x 55.7	3	premium UHPC-25.0-690-3S	10470							
60	3.0	3.3	4.9	9.1	10.1	10.8	12.2	14.5	17.4	22.7	30.0	25.1		2	basic UHPC-25.0-690-3S	10487							
50	2.7	2.9	4.3	8.0	8.8	9.5	10.7	12.7	15.2	19.9	26.3	22.0	3 x 58.6	3	premium UHPC-26.3-690-3S	10476							
60	3.2	3.5	5.2	9.6	10.6	11.4	12.8	15.3	18.3	23.9	31.6	26.4		3	basic UHPC-26.3-690-3S	10488							
50	2.8	3.1	4.6	8.4	9.3	10.1	11.3	13.5	16.1	21.0	27.8	23.3	3 x 62.0	3	premium UHPC-27.8-690-3S	10478							
60	3.4	3.7	5.5	10.1	11.2	12.1	13.6	16.1	19.3	25.2	33.4	27.9		3	basic UHPC-27.8-690-3S	10489							
50	3.0	3.3	4.9	9.0	10.0	10.7	12.0	14.3	17.1	22.4	29.6	24.8	3 x 66.0	3	premium UHPC-29.6-690-3S	10477							
60	3.6	4.0	5.9	10.8	11.9	12.9	14.4	17.2	20.6	26.9	35.5	29.7		3	basic UHPC-29.6-690-3S	10490							

Measurements table on page 35

Performance data and sizes deviating from the standard are available on request.
Misprints and printing errors as well as technical changes reserved.

Example for order: Power capacitor, 30.3 kvar to 440 V.

The corresponding order detail is as follows: **Type multicond premium UHPC-30.3-440-3P (3-phase version) = item number 10303**

Type multicond basic UHPC-30.3-440-3P (3-phase version) = product number 10336

multicond

Capacitor rated voltage: **800 V – Basic and Premium Y-circuit**

FREQUENCY												CURRENT ON MAX. VOLTAGE	RATED CAPACITANCE	CONSTRUCTION TYPE	TYPE	Item no.
	280 V	380V	400V	415V	440V	480V	525V	600V	660V	690V	800V					
Hz	kvar	kvar	kvar	kvar	kvar	kvar	kvar	kvar	kvar	kvar	kvar	A	μF			
50	-	-	3,3	3,6	4,0	4,8	5,7	7,5	9,1	9,9	13,3	9,6	3 x 22.1	1	premium UHPC-13.3-800-3S	21818
60	-	-	4,0	4,3	4,8	5,8	6,9	9,0	10,9	11,9	16,0	11,5		1	basic UHPC-13.3-800-3S	21806
50	-	-	4,2	4,5	5,0	6,0	7,2	9,4	11,3	12,4	16,6	12,0	3 x 27.6	2	premium UHPC-16.6-800-3S	21819
60	-	-	5,0	5,4	6,0	7,2	8,6	11,2	13,6	14,9	20,0	14,4		1	basic UHPC-16.6-800-3S	21807
50	-	-	5,0	5,4	6,1	7,2	8,6	11,3	13,7	14,9	20,1	14,5	3 x 33.3	2	premium UHPC-20.1-800-3S	21820
60	-	-	6,0	6,5	7,3	8,7	10,4	13,5	16,4	17,9	24,1	17,4		2	basic UHPC-20.1-800-3S	21809
50	-	-	5,7	6,2	6,9	8,2	9,8	12,9	15,6	17,0	22,9	16,5	3 x 37.9	2	premium UHPC-22.9-800-3S	21821
60	-	-	6,9	7,4	8,3	9,9	11,8	15,4	18,7	20,4	27,4	19,8		2	basic UHPC-22.9-800-3S	21811
50	-	-	6,7	7,2	8,1	9,6	11,5	15,0	18,1	19,8	26,7	19,3	3 x 44.2	3	premium UHPC-26.7-800-3S	21822
60	-	-	8,0	8,6	9,7	11,5	13,8	18,0	21,8	23,8	32,0	23,1		2	basic UHPC-26.7-800-3S	21812
50	-	-	7,0	7,5	8,4	10,0	12,0	15,7	19,0	20,7	27,9	20,1	3 x 46.2	3	premium UHPC-27.9-800-3S	21823
60	-	-	8,4	9,0	10,1	12,0	14,4	18,8	22,8	24,9	33,4	24,1		2	basic UHPC-27.9-800-S	21813
50	-	-	7,9	8,5	9,6	11,4	13,6	17,8	21,6	23,6	31,7	22,9	3 x 52.5	3	premium UHPC-31.7-800-3S	21997
60	-	-	9,5	10,2	11,5	13,7	16,4	21,4	25,9	28,3	38,0	27,4		3	basic UHPC-31.7-800-3S	21996
50	-	-	8,3	9,0	10,1	12,0	14,4	18,8	22,7	24,8	33,4	24,1	3 x 55.4	3	premium UHPC-33.4-800-3S	21824
60	-	-	10,0	10,8	12,1	14,4	17,3	22,5	27,3	29,8	40,1	28,9		3	basic UHPC-33.4-800-3S	21814
50	-	-	8,8	9,5	10,7	12,7	15,2	19,9	24,1	26,3	35,4	25,5	3 x 58.6	3	premium UHPC-35.4-800-3S	21825
60	-	-	10,6	11,4	12,8	15,3	18,3	23,9	28,9	31,6	42,4	30,6		3	basic UHPC-35.4-800-3S	21815
50	-	-	9,1	9,8	11,0	13,1	15,6	20,4	24,7	27,0	36,3	26,2	3 x 60.2	3	premium UHPC-36.3-800-3S	21826
60	-	-	10,9	11,7	13,2	15,7	18,8	24,5	29,6	32,4	43,6	31,5				
50	-	-	9,3	10,1	11,3	13,4	16,1	21,0	25,4	27,8	37,4	27,0	3 x 61,9	3	basic UHPC-37.4-800-3S	21816
60	-	-	11,2	12,1	13,6	16,1	19,3	25,2	30,5	33,3	44,8	32,3				
50	-	-	9,9	10,7	12,0	14,3	17,1	22,4	27,1	29,6	39,8	28,7	3 x 66,0	3	basic UHPC-39.8-800-3S	21817
60	-	-	11,9	12,8	14,4	17,2	20,6	26,9	32,5	35,5	47,7	34,4				

Measurements table on page 35

Other capacitor powers on request

On request a 4 pole terminal with lead out neutral wire is available.

(suitable for 3 phase controlled pfc units)

Those capacitors can also be used as 3 one phase capacitors in one can.

Only available with diameter of 136mm.

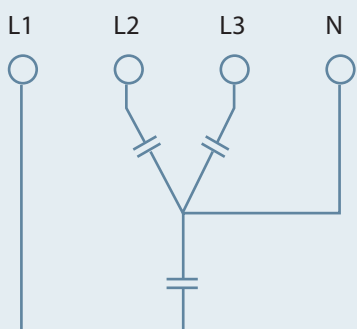

Construction diagram

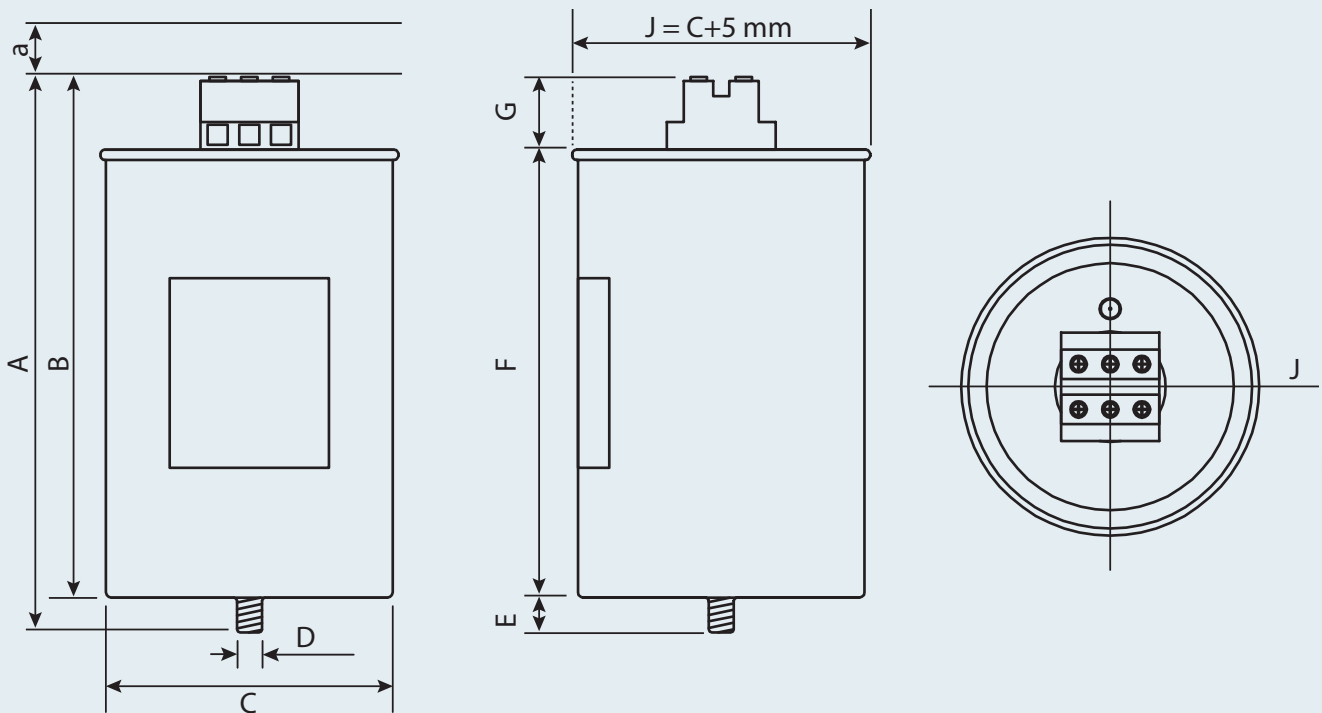

All dimensions are in mm.
Not suitable for measurement purposes.

General:

- Adapter box safe from finger-touch
- Expansion by 12 mm maximum
- Clearance above (a) 13 mm minimum

Installation:

- M12 threaded bolts
- tightening torque $T = 10 \text{ Nm}$
- serrated lock washer J12 DIN 6797
- hexagonal nut BM12 DIN 439

Adapter box:

C 95/116/136 (25 mm²)

- M5 connection screw
- tightening torque $T = 2.5 \text{ Nm}$

C 75 (16 mm²)

- M4 connection screw
- tightening torque $T = 1.3 \text{ Nm}$

Size Chart	A ¹	B ¹	C ¹	D ²	E ¹	F ¹	G ¹	J ^{1,3}	
Construction Type 1	263	246,5	95	11,8 / M12	16,5	212	34,5	100	mm
Construction Type 2	263	246,5	116	11,8 / M12	16,5	212	34,5	121	mm
Construction Type 3	263	246,5	136	11,8 / M12	16,5	212	34,5	141	mm
Construction Type 4	260	243,5	75	11,8 / M12	16,5	212	31,5	79	mm
Construction Type 5	350	334,0	136	11,8 / M12	16,0	290	44,0	141	mm

¹ tolerance +/- 3 mm

² mm / threaded bolts

³J = C + 5 mm

	multicond premium UHPC und multicond UHPC	multicond basic UHPC	multicond light UHPC
Rated voltage	$U_n = 280, 415, 440, 480, 525, 690$ or 800 V	$U_n = 280, 440, 480, 525, 690$ or 800 V	$U_n = 280, 440, 480, 525$ or 690 V
Frequency	50/60 Hz	50/60 Hz	50/60 Hz
Maximum permissible operating voltage	1.0 x U_n continuous 1.1 x U_n 8 hours/day 1.15 x U_n 30 minutes/day 1.2 x U_n 200 x 5 minutes 1.3 x U_n 200 x 1 minute		
Maximum permissible operating current	$2.0 \times I_n$	$2.0 \times I_n$	$1.8 \times I_n$
Maximum inrush current	$400 \times I_n$	$400 \times I_n$	$250 \times I_n$
Capacitance tolerance	+/- 5 %	+/- 5 %	+/- 5 %
Power dissipation	< 0.20 W/kvar, without discharge resistors	< 0.25 W/kvar, without discharge resistors	< 0.25 W/kvar, without discharge resistors
Voltage test (terminal – terminal)	$2.15 \times U_{rated}$ (AC), 10 sec	$2.15 \times U_{rated}$ (AC), 10 sec	$2.15 \times U_{rated}$ (AC), 10 sec
Voltage test (terminal – housing)	≤ 690 V : 3600 V (AC), 2.5 sec > 690 V : 6000 V (AC), 10 sec - acc. to standard		
Cooling	Natural cooling	Natural cooling	Natural cooling
Permissible humidity	95 %	95 %	95 %
Maximum altitude	4000 m above sea level	4000 m above sea level	4000 m above sea level
Installation site, installation position	Indoors, anywhere	Indoors, anywhere	Indoors, anywhere
Attachment	M12 threaded bolts on the ground	M12 threaded bolts on the ground	M12 threaded bolts on the ground
Safety features	→ Dry technology, resin-filled → Self-restoring → Overpressure disconnecter (all-pole) → SF6-free, PCB-free	→ Dry technology, resin-filled → Self-restoring → Overpressure disconnecter (all-pole) → SF6-free, PCB-free	→ Dry technology, resin-filled → Self-restoring → Overpressure disconnecter (all-pole) → SF6-free, PCB-free
Housing	Aluminum		
Protection type	IP 20		
Dielectric	Polypropylene		
Terminal strips	double-sided terminal strip, safe from finger-touch		
Discharge	Discharge resistors on the outside of the strip		
Standards	IEC 60831-1 + 2, EN 60831-1 + 2, VDE 0560-46 + 47		

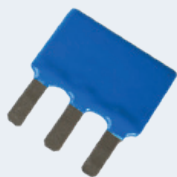

The discharge of the capacitors takes place via discharge resistors or discharge reactors.

The standard requires a discharge of the capacitor that, as a rule, is realized via discharge resistors.

If faster discharge is necessary, the capacitor can be discharged with a discharge reactor within a very short time.

The capacitor is thus available again for compensation after a short time.

Type	Item no.	Power	Dimensions (H x W x D) in mm	Connection
multidis-EW 120k-3P-5W	17141	5 W	4 x 39 x 30	Terminal lugs
multidis-EW 120k-3P-9W	19410	9 W	4 x 39 x 46	Terminal lugs
multidis-EW 300k-3P	17142	5W	4 x 39 x 30	Terminal lugs
multidis-EW 400k-3P	17143	9W	4 x 39 x 46	Terminal lugs
multidis-ED 100-900V	15464		35 x 60 x 90	cable 600 mm

	multicond premium UHPC und multicond UHPC	multicond basic UHPC	multicond light UHPC
<p>Temperature class D+5:</p> <p>Operating life* > 150,000 h</p> <p>max. ambient temperature: 60 °C max. average over 24 hours: 50 °C max. average over 1 year: 40 °C</p>	<p>Temperature class D+5</p> <p>Life expectancy 150000h</p>		
<p>Temperature class D:</p> <p>Operating life* > 250,000 h</p> <p>max. ambient temperature: 55 °C max. average over 24 hours: 45 °C max. average over 1 year: 35 °C</p>	<p>Temperature class D</p> <p>Life expectancy 250000h</p>	<p>Temperature class D</p> <p>Life expectancy 130000h</p>	<p>Temperature class D</p> <p>Operating Life 100000h</p>
<p>Temperature class C:</p> <p>Operating life* > 150,000 h</p> <p>max. ambient temperature: 50 °C max. average over 24 hours: 40 °C max. average over 1 year: 30 °C</p>		<p>Temperature class C</p> <p>Life expectancy 150000h</p>	<p>Temperature class C</p> <p>Life expectancy 130000h</p>

***The maximum operating life depends on the type of the application and the temperature class**

Storage conditions for capacitors:

- min. / max. temp.: -40 - + 85 °C
- max. air humidity: <95% without condensation

Do not store in corrosive atmosphere containing aerosols, especially if chloride gas, sulfur compounds, salts (marine air) or similar is present.

Filter circuit reactors

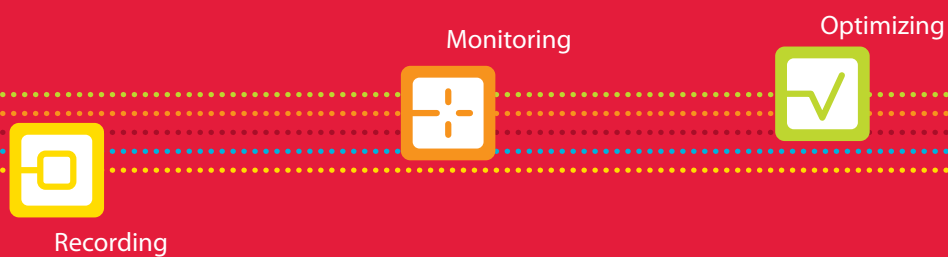

To prevent resonance phenomena caused by harmonic content in the power supply system, filter circuit reactors are required to set up detuned compensation systems. Here, high linearities guarantee the necessary functional stability even in the overload range.

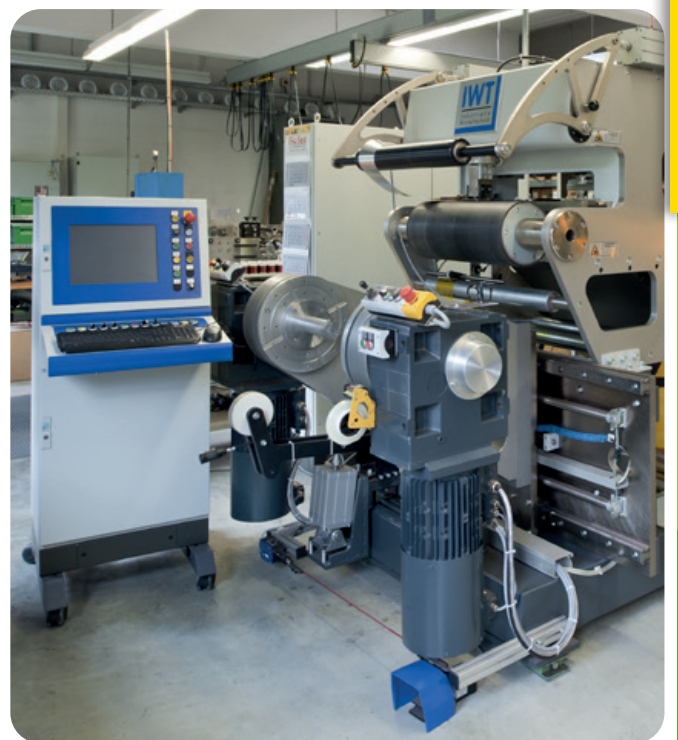
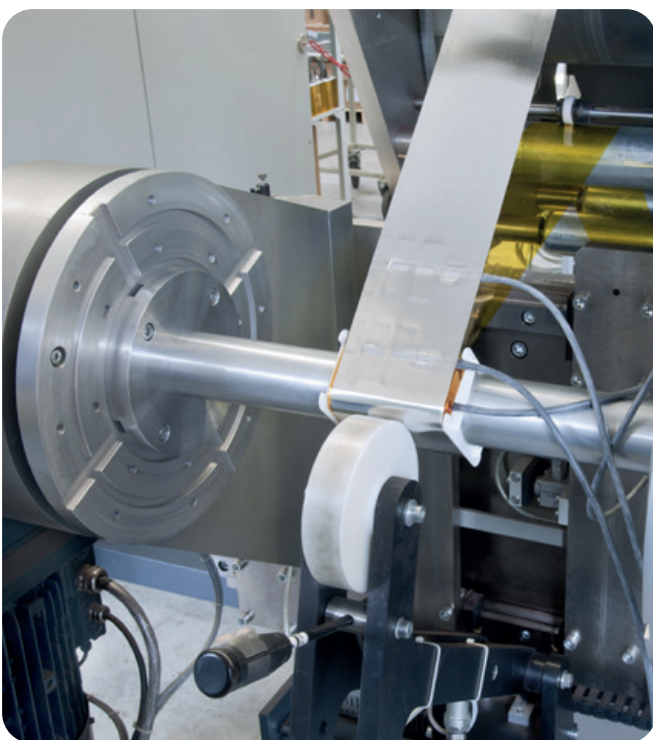

About us

Basics

Reactive power controllers

Power capacitors

Filter circuit reactors

Capacitor contactors and thyristor switches

KBR system

multiind 50Hz

Power	2.5 – 75 kvar
Detuning factors	5.5, 7 or 8 % 12.5 or 14 %

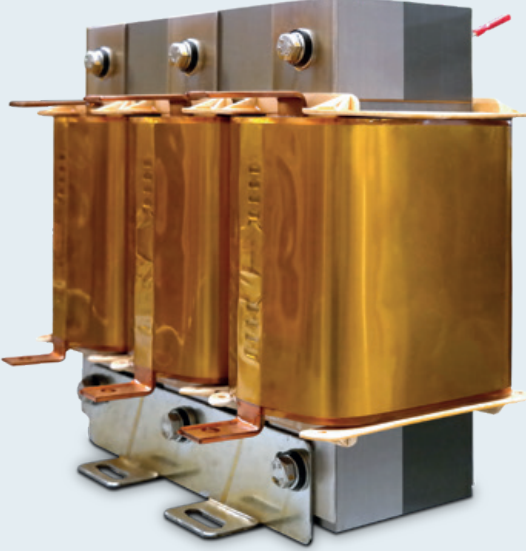

Filter circuit reactors for reactive current compensation

Highlights

- Power from 2.5 to 75 kvar
- High linearity, low power dissipation
- Overload protection through temperature switch
- Low-noise through impregnation
- Long operating life
- Improved impedance behavior

An overview of the **technical details** is provided on pages 44-45.
Construction diagrams are provided on page 43.

Note on the temperature switch

For smooth operation and a long operating life, the integrated temperature sensor must interrupt the main circuit of the filter circuit reactor in case of overload.

Notes on installation

- Observe the applicable DIN / VDE regulations.
- Power supply connection, setup and device operation must be performed by qualified personnel only.
- Maintain maximum current, voltage and temperature ranges.
- Ensure sufficient ventilation.
- Tighten connections with the right torque.

Specifications multiind-light ... 7 %

Detuning factor: **7%** Resonance frequency: **189 Hz**

POWER kvar	TYPE multiind-basic... 7 %	INDUC- TIVITY		RATED CURRENT A	DIMENSIONS IN MM in mm							DIAGRAM	WEIGHT kg	CAPACI- TANCE µF	CAPACITOR multicond UHPC ... -440-3P		
		CU	AL		mH	H	W	D	W1	D1	LL					AW	RK
12,5	multiind-light 400-50-12.5-7-Cu-RK-S	x		2.848	18	215	210	92	95	67,5	9		x	B	12.6	249	15,1
25	multiind-light 400-50-25.0-7-Cu-RK-S	x		1.535	36	250	240	105	95	82	9		x	B	16.0	462	28,1
50	multiind-light 400-50-50.0-7-Cu-RK-S	x		0.767	72,1	250	240	145	95	101	9		x	B	25.0	924	28,1+28,1

Specifications multiind-basic ... 7 %

Detuning factor: **7%** Resonance frequency: **189 Hz**

POWER kvar	TYPE multiind-basic... 7 %	INDUC- TIVITY		RATED CURRENT A	DIMENSIONS IN MM in mm							DIAGRAM	WEIGHT kg	CAPACI- TANCE µF	CAPACITOR multicond UHPC ... -440-3P		
		CU	AL		mH	H	W	D	W1	D1	LL					AW	RK
2,5	multiind-basic 400-50-02.5-7-Cu-RK-S	x		15.42	3,6	185	180	86	95	62,5	9		x	B	5,2	46	UHPC 4,0 -525-3P
5	multiind-basic 400-50-05.0-7-Cu-RK-S	x		7.709	7,2	185	180	106	95	62,5	9		x	B	6,4	92	UHPC 8,0-525-3P
7,5	multiind-basic 400-50-07.5-7-Cu-RK-S	x		4.760	11,6	185	180	96	95	72,5	9		x	B	8,1	150	UHPC 13,0 -525-3P
10	multiind-basic 400-50-10.0-7-Cu-RK-S	x		3.564	15,5	185	180	126	95	82,5	9		x	B	9,2	199	12,1
12,5	multiind-basic 400-50-12.5-7-CU-RK-S	x		2.849	19,4	215	210	109	95	85	9		x	B	12,6	249	15,1
15	multiind-basic 400-50-15.0-7-CU-RK-S	x		2.524	21,9	215	210	109	95	85	9		x	B	13,0	281	17,1
20	multiind-basic 400-50-20.0-7-CU-RK-S	x		1.782	31,1	215	210	109	95	85	9		x	B	14,0	398	24,2
25	multiind-basic 400-50-25.0-7-AL-AW-S		x	1.535	36,0	220	240	145	95	92	9	x		C	17,1	462	28,1
25	multiind-basic 400-50-25.0-7-CU-RK-S	x		1.535	36,0	250	240	115	95	92	9		x	B	20,0	462	28,1
30	multiind-basic 400-50-30.0-7-AL-AW-S		x	1.262	43,8	220	240	145	95	92	9	x		C	17,8	562	17,1+17,1
30	multiind-basic 400-50-30.0-7-CU-RK-S	x		1.262	43,8	250	240	135	95	92	9		x	B	20,3	562	17,1+17,1
40	multiind-basic 400-50-40.0-7-AL-AW-S		x	0.951	58,2	240	260	167	95	112	9	x		C	26,0	746	21,2+24,2
50	multiind-basic 400-50-50.0-7-AL-AW-S		x	0.767	72,1	240	260	167	95	112	9	x		C	25,0	924	28,1+28,1
50	multiind-basic 400-50-50.0-7-CU-RK-S	x		0.767	72,1	305	300	145	95	105	9		x	B	32,0	924	28,1+28,1
60	multiind-basic 400-50-60.0-7-AL-AW-S		x	0.638	86,8	270	300	180	95	117	9	x		C	35,0	1112	10,0(525)+30,3+30,3
75	multiind-basic 400-50-75.0-7-AL-AW-S		x	0.512	108,0	270	300	180	95	117	9	x		C	37,5	1386	28,1+28,1+28,1

multiind 50Hz

Specifications multiind-basic ... 14 %

Detuning factor: **14 %** Resonance frequency: **134 Hz**

POWER kvar	TYPE multiind-light... 14 %	INDUCTIVITY		RATED CURRENT	DIMENSIONS							CONNECTION		DIAGRAM	WEIGHT kg	CAPACITANCE μF	CAPACITOR multicond UHPC... -525-3P
		CU	AL		mH	A	H	W	D	W1	D1	LL	AW				
5	multiind-basic 400-50-05.0-14-CU-RK-S	x		15.42	7,8	185	180	96	95	72,5	9		x	B	8,3	92	8,0
7,5	multiind-basic 400-50-07.5-14-CU-RK-S	x		11,00	10,9	215	230	109	95	85	9		x	B	12,5	129	11,2
10	multiind-basic 400-50-10.0-14-CU-RK-S	x		8.2	14,6	215	210	109	95	85	9		x	B	14,4	173	15,0
12,5	multiind-basic 400-50-12.5-14-CU-RK-S	x		6.82	17,6	250	240	105	95	82	9		x	B	17,9	208	18,0
15	multiind-basic 400-50-15.0-14-CU-RK-S	x		5.862	20,4	250	240	105	95	82	9		x	B	17,9	242	21,0
20	multiind-basic 400-50-20.0-14-AL-AW-S		x	4.088	29,3	240	260	167	95	112	9		x	B	24,2	347	30,0
25	multiind-basic 400-50-25.0-14-CU-RK-S	x		3.322	36	250	240	145	95	101	9	x		C	23,4	427	37,0
25	multiind-basic 400-50-25.0-14-AL-AW-S		x	3.322	36	240	260	167	95	112	9	x		C	24,9	427	37,0
30	multiind-basic 400-50-30.0-14-AL-AW-S		x	2.728	43,9	270	300	180	95	117	9	x		C	33,0	520	15,0+30,0
40	multiind-basic 400-50-40.0-14-AL-AW-S		x	2.047	58,5	270	300	180	95	117	9	x		C	36,2	693	30,0+30,0
50	multiind-basic 400-50-50.0-14-AL-AW-S		x	1.661	72	270	300	210	95	132	9	x		C	44,0	854	37,0+37,0
50	multiind-basic 400-50-50.0-14-CU-RK-S	x		1.661	72,1	305	300	180	95	117	9		x	B	45,5	854	37,0+37,0
60	multiind-basic 400-50-60.0-14-AL-AW-S		x	1.364	87,7	270	300	210	95	132	9	x		C	40,0	1040	30,0+30,0+30,0
60	multiind-basic 400-50-60.0-14-CU-RK-S	x		1.364	87,7	305	300	210	95	132	9		x	B	47,6	1040	30,0+30,0+30,0

Technical data

multiind 7.0

DEVICE TYPE

light

$p = 7 \%$

basic

$p = 7 \%$

basic

$p = 14 \%$

Rated voltage frequency	$U_n = 400 \text{ V} \mid 50\text{Hz}$	$U_n = 400 \text{ V} \mid 50\text{Hz}$	$U_n = 400 \text{ V} \mid 50 \text{ Hz}$
Maximum permissible operating voltage	$U_n = 400 \text{ V} \pm 10\%$	$U_n = 400 \text{ V} \pm 10\%$	$U_n = 400 \text{ V} \pm 10\%$
Power	2.5 – 75 kvar	2.5 – 75 kvar	2.5 – 50 kvar
Inductive stability Inductive tolerance	$L (I_{Lin}) \geq 0.95 L_N \mid \pm 3\%$	$L (I_{Lin}) \geq 0.95 L_N \mid \pm 3\%$	$L (I_{Lin}) \geq 0.95 L_N \mid \pm 3\%$
Overtemperature protection	Break contact at 125 °C (250 V – 50 Hz – 2.5 A), temperature class B		
Protection type	IP 00	IP 00	IP 00
Protection class	I	I	I
Ambient temperature	maximum 40 °C	maximum 40 °C	maximum 40 °C
Cooling type	Natural cooling	Natural cooling	Natural cooling
Impregnation	vacuum-impregnated	vacuum-impregnated	vacuum-impregnated
Detuning factor Resonance frequency	7 % 189 Hz	7 % 189 Hz	14 % 134 Hz
Linearity	$1.6 \times I_{rated}$	$1.85 \times I_{rated}$	$1.5 \times I_{rated}$
Standards	DIN EN 60076-6 (VDE 0532-76-6) DIN EN 61558-1-A1 (VDE 0570-1-A1) DIN EN 61558-2-20 (VDE 0570-2-20)		
Designs	Cu = copper Al = aluminum L = cable connection AW = connection angle RK = tubular cable lug		

Construction diagrams

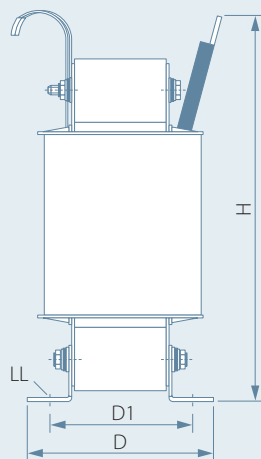
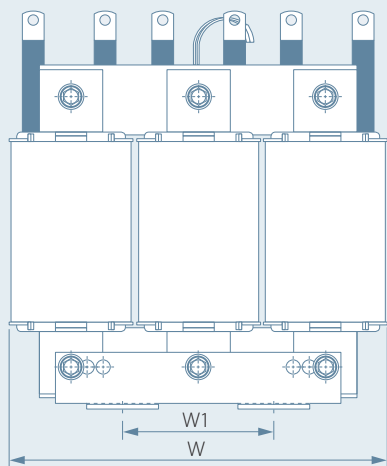

Diagram B

Design with tubular cable lug
Type RK

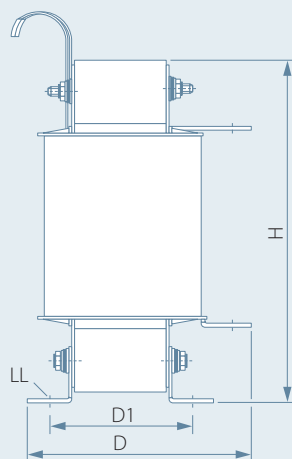
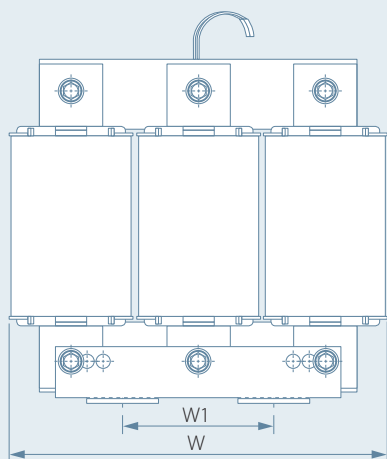

Diagram C

Design with connection angle
Type AW

multiind 60Hz

Specifications multiind-basic ... 6%

Detuning: **6%** Resonance frequency: **245 Hz**

VOLTAGE V	POWER kvar	TYPE multiind-basic ... 6%	INDUCTIV- ITY		RATED CURRENT A	DIMENSIONS						CONNECTION			DIAGRAM	WEIGHT kg	CAPACITANCE µF	CAPACITOR multicond UHPC	
			Cu	Al		mH	H	W	D	W1	D1	LL	L	AW					RK
380V/60Hz	12.5	multiind-basic 380-60-12.5-6-CU-RK-S	x		1.8280	20.3	215	210	109	95	85	9			x	B	13.5	231	1x 20.0-525-3P
380V/60Hz	13.4	multiind-basic 380-60-13.4-6-CU-RK-S	x		1.8250	20.3	215	210	109	95	85	9			x	B	13.5	231	1x 16.7-480-3P
380V/60Hz	25	multiind-basic 380-60-25.0-6-AL-AW-S		x	0.9490	39.2	240	260	167	95	112	9		x		C	24.5	445	1x 17.9-480-3P 1x 14.3-480-3P
380V/60Hz	26.7	multiind-basic 380-60-26.7-6-CU-RK-S	x		0.9160	40.6	250	240	115	95	92	9			x	B	21	461	1x 33.4-480-3P
380V/60Hz	50	multiind-basic 380-60-50.0-6-CU-RK-S	x		0.4840	76.8	305	300	150	95	117	9			x	B	34.1	873	1x 29.8-480-3P 2x 33.4-480-3P
440V/60Hz	12.5	multiind-basic 440-60-12.5-6-CU-RK-S	x		2.4403	17.6	215	210	109	95	85	9			x	B	11.8	173	1x 15.0-525-3P
440V/60Hz	25	multiind-basic 440-60-25.0-6-AL-AW-S		x	1.2166	35.4	220	240	145	95	92	9		x		C	17.6	347	1x 30.0-525-3P
440V/60Hz	50	multiind-basic 440-60-50.0-6-AL-AW-S		x	0.6416	67	270	300	180	95	117	9		x		C	33	658	1x 20.0-525-3P 1x 37.0-525-3P

Specifications multiind-basic ... 7%

Detuning: **7%** Resonance frequency: **227Hz**

VOLTAGE V	POWER kvar	TYPE multiind-basic ... 7%	INDUCTIV- ITY		RATED CURRENT A	DIMENSIONS						CONNECTION			DIAGRAM	WEIGHT kg	CAPACITANCE µF	CAPACITOR multicond UHPC	
			Cu	Al		mH	H	W	D	W1	D1	LL	L	AW					RK
230V/60Hz	10	multiind-basic 230-60-10-7-CU-RK-S	x		1.0661	24.9	215	210	109	95	85	9			x	B	13.8	462	1x 28.1-440-3P
230V/60Hz	20	multiind-basic 230-60-20-7-CU-RK-S	x		0.5319	49.9	250	240	129	95	105	9			x	B	22.2	925.5	1x 20.0-440-3P 1x 36.3-440-3P
480V/60Hz	25	multiind-basic 480-60-25.0-7-AL-AW-S		x	1.7043	32.5	220	240	145	95	92	9		x		C	17.3	289	1x 25.0-525-3P
480V/60Hz	50	multiind-basic 480-60-50.0-7-AL-AW-S		x	0.9276	59.7	240	260	167	95	112	9		x		C	27.0	531	1x 21.0-525-3P 1x 25.0-525-3P

Specifications multiind-basic ... 13%

Detuning: **13%** Resonance frequency: **167 Hz**

VOLTAGE V	POWER kvar	TYPE multiind-basic ... 13%	INDUCTIV- ITY		RATED CURRENT A	DIMENSIONS						CONNECTION			DIAGRAM	WEIGHT kg	CAPACITANCE µF	CAPACITOR multicond UHPC	
			Cu	Al		mH	H	W	D	W1	D1	LL	L	AW					RK
380V/60Hz	12.5	multiind-basic 380-60-12.5-13-CU-RK-S	x		4.3976	19.8	250	240	105	95	82	9			x	B	16	207.9	1x 18.0-525-3P
380V/60Hz	25	multiind-basic 380-60-25.0-13-AL-AW-S		x	2.1988	39.5	270	300	180	95	117	9		x		C	32	416	2x 18.0-525-3P
380V/60Hz	50	multiind-basic 380-60-50.0-13-AL-AW-S		x	1.0698	81.3	270	300	180	95	117	9		x		C	33	855	2x 37.0-525-3P
440V/60Hz	12.5	multiind-basic 440-60-12.5-13-CU-RK-S	x		6.0980	16.5	215	210	109	95	85	9			x	B	15	150	1x 13.0-525-3P
440V/60Hz	25	multiind-basic 440-60-25.0-13-AL-AW-S		x	3.0490	33	240	260	167	95	112	9		x		C	24	300	2x 13.0-525-3P
440V/60Hz	50	multiind-basic 440-60-50.0-13-AL-AW-S		x	1.5250	66	270	300	180	95	117	9		x		C	33	600	1x 15.0-525-3P 1x 37.0-525-3P

multiind 60Hz technical details

DEVICE TYPE	multiind 6 %		multiind 7 %		multiind 13 %	
	basic p = 6 %	basic p = 6 %	basic p = 7 %	basic p = 7 %	basic p = 13 %	basic p = 13 %
Rated voltage	U _n = 380 V	U _n = 440 V	U _n = 230 V	U _n = 480 V	U _n = 380 V	U _n = 440 V
Frequency	60 Hz	60 Hz	60 Hz	60 Hz	60 Hz	60 Hz
Maximum permissible operating voltage	U _n = 380 V ± 10 %	U _n = 440 V ± 10 %	U _n = 230 V ± 10 %	U _n = 480 V ± 10 %	U _n = 380 V ± 10 %	U _n = 440 V ± 10 %
Power	12.5 x 13.4, 25; 26.7; x 50 kvar	12.5 x 25; 50 kvar	10; 20 kvar	25; 50 kvar	12.5 x 25; 50 kvar	12.5 x 25; 50 kvar
Inductive stability	L (I _{Lin}) ≥ 0.95 L _N		L (I _{Lin}) ≥ 0.95 L _N		L (I _{Lin}) ≥ 0.95 L _N	
Inductive tolerance	± 3 %		± 3 %		± 3 %	
Overtemperature protection	Break contact at 125 °C (250 V – 50 Hz – 2.5 A)		Break contact at 125 °C (250 V – 50 Hz – 2.5 A)		Break contact at 125 °C (250 V – 50 Hz – 2.5 A)	
Protection type	IP 00		IP 00		IP 00	
Protection class	I		I		I	
Ambient temperature	Maximum 40 °C		Maximum 40 °C		Maximum 40 °C	
Cooling type	Natural cooling		Natural cooling		Natural cooling	
Impregnation	Vacuum-impregnated		Vacuum-impregnated		Vacuum-impregnated	
Detuning	6 %	6 %	7 %	7 %	13 %	13 %
Resonance frequency	245 Hz	245 Hz	227 Hz	227 Hz	167 Hz	167 Hz
Linearity	1.85 x I _{rated}	1.85 x I _{rated}	1.85 x I _{rated}	1.85 x I _{rated}	1.5 x I _{rated}	1.5 x I _{rated}
Standards	DIN EN 60289 (VDE 0532-289)		DIN EN 60289 (VDE 0532-289)		DIN EN 60289 (VDE 0532-289)	
Designs	Cu = copper Al = aluminum L = cable connection AW = connection angle RK = tubular cable lug					

Capacitor contactors

multiswitch low-voltage switching devices are produced and tested according to the relevant national and international rules and regulations. All of the devices correspond to all important German regulations, such as VDE, BS and the relevant international standards, such as IEC 60947 and UL508. This is why our low-voltage switching devices can be used worldwide.



Thyristor switches

With thyristor switches, you can connect and disconnect capacitors quickly and without wear and tear.

Unlimited switching frequency, no peak inrush current when switching on capacitors, rapid compensation and no noise formation during switching are just some of the advantages of this technology.

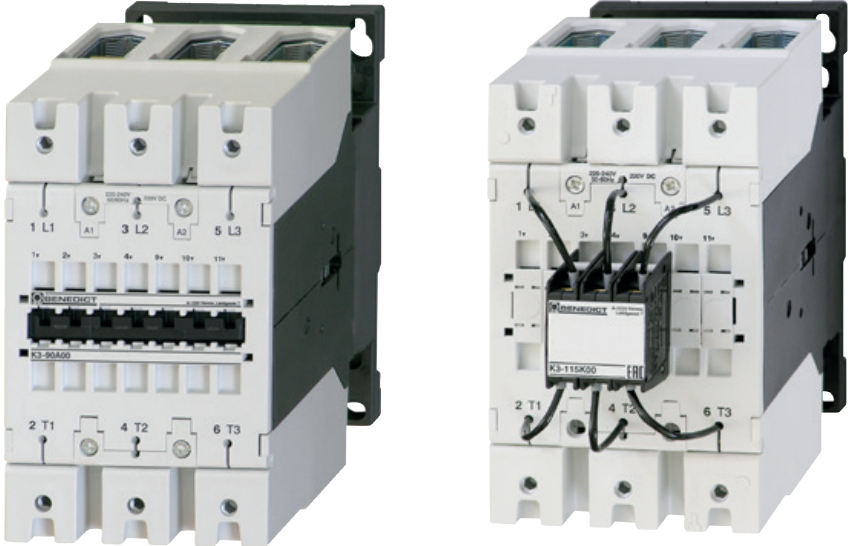

About us

Basics

Reactive power controllers

Power capacitors

Filter circuit reactors

Capacitor contactors and thyristor switches

KBR system

multiswitch capacitor contactor



K3-10N...
K3-14N...
K3-18N...
K3-22N...



K3-24...
K3-32...
K3-40...



K3-50...
K3-62...
K3-74...



K3-90...
K3-115...

Capacitor contactors without early make contacts

Specifications:

K3 power contactors... are well-suited for switching of de-tuned filter circuit capacitor batteries (IEC 70 and 831) with reactors.

Operating conditions:

Only for use in detuned compensation systems! Power contactors do not have early make contacts and damping resistors.

TYPE	Item no.	Power in kvar at 50 °C
K3-18ND-10-230	10521	12.5
K3-32A-00-230	10524	25.0
K3-62A-00-230	10527	50.0
K3-74A-00-230	10532	75.0
K3-90A-00-230	10528	80.0
K3-115A-00-230	10533	100.0

Technical data in accordance with IEC 947, EN 60947

TYPE			10ND	14ND	18ND	22ND	24A	32A	40A	50A	62A	74A	90A	115A
AC3	400 V	Motor	10A	14A	18A	22A	24A	32A	40A	50A	62A	74A	90A	115A
		380-400 V	4 kW	5.5 kW	7.5 kW	11 kW	11 kW	15 kW	18.5 kW	22 kW	30 kW	37 kW	45 kW	55 kW
		660-690 V	5.5 kW	7.5 kW	10 kW	10 kW	15 W	18.5 kW	18.5 kW	30 kW	37 kW	45 kW	55 kW	55 kW
AC1	690V at 40 °C		25A	25A	32A	32A	50A	65A	80A	110A	120A	1230A	160A	200A
TYPE	K3-		10ND10	14ND10	18ND10	22ND10	24A00	32A00	40A00	50A00	62A00	74A00	90A00	115A00
	Auxiliary contacts		1S	1S	1S	1S	-	-	-	-	-	-	-	-
	K3-		10ND01	10ND01	18ND01	22ND01								
			1Ö	1Ö	1Ö	1Ö								
Connection cross sections	single-wire or multi-wire	mm ²	0.75 - 6				1.5 - 25			4 - 50			10 - 120	
	fine-wire	mm ²	1 - 4				2.5 - 16			10 - 35			10 - 95	
Auxiliary contact	I _{th} 40 °C	A	10				-			-			-	
	AC15 230 V	A	3				-			-			-	
	400 V	A	2				-			-			-	
Power of the magnetic coils		VA	33 - 45				90 - 115			140 - 165			28/0	
		VA	7 - 10				9 - 13			13 - 18			5	
	Control voltage range		0.85 - 1.1				0.85 - 1.1			0.85 - 1.1			0.85 - 1.1	
Assembly	Quick fastening on 35 mm DIN rail and screw fastening												2 rails or screws	

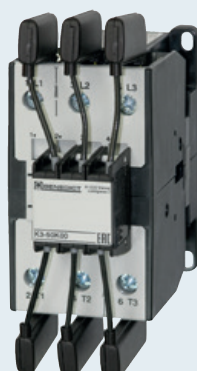
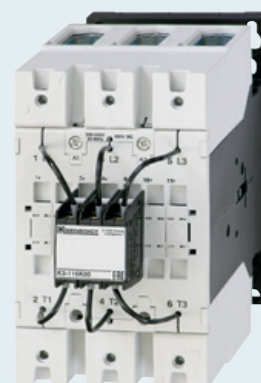

K3-18NK...

 K3-24K...
K3-32K...

 K3-50K...
K3-62K...
K3-74K...

 K3-90K...
K3-115K...

Capacitor contactors for switching detuned and not detuned (without filter circuit reactors) compensation systems with early make contacts

Specifications:

K3-..K capacitor contactors are well-suited for detuned and not detuned batteries (IEC70 and 831, VDE 0560) with and without filter circuit reactors. Capacitor contactors are equipped with early make contacts switches and damping resistors in order to reduce inrush peaks to $<70 \times I_e$.

Conditions of use:

Capacitor contactors are weld-resistant to a prospective maximum inrush current of $200 \times I_e$.

TYPE	Item no.	Power in kvar at 50 °C
K3-18K-10-230	10520	12.5
K3-32K-00-230	10523	25.0
K3-62K-00-230	10526	50.0
K3-74K-00-230	10525	75.0
K3-90K-00-230	10531	80.0
K3-115K-00-230	21592	100.0

Technical data in accordance with IEC 947-4-1, IEC 947-5-1, EN 60947-4-1, EN 60947-5-1, VDE 0660

TYPE		K3-18NK	K3-24K	K3-32K	K3-50K	K3-62K	K3-74K	K3-90K	K3-115K	
Switching frequency z	1/h	120	120	120	120	120	80	80	80	
Contact life of untuned capacitors	$S \times 10^3$	250	150	150	150	150	120	120	120	
Contact life of detuned capacitors	$S \times 10^3$	400	300	300	300	300	200	200	200	
Rated operating current I_e AC6b	at 50 °C	A	0-18	14-28	14-36	30-48	30-72	30-108	50-115	50-144
	at 60 °C	A	0-18	14-28	14-36	30-48	30-72	30-87	50-108	50-130
Rated thermal current I_{th} AC1	at 50 °C	A	32	45	60	100	110	120	155	190
	at 60 °C	A	32	40	55	90	100	110	145	170
Overload factor according to EN 61921 at least 30%	at 50 °C	%	78	60	67	108	53	11	35	32
	at 60 °C	%	78	43	53	88	39	26	34	31
Fuses gL (gG)	from/to	A	35/63	50/80	63/100	80/160	125/160	160/200	160/200	160/250

multiswitch capacitor contactor

Capacitor contactors without early make contacts

K3-10N...
K3-14N...
K3-18N...
K3-22N...

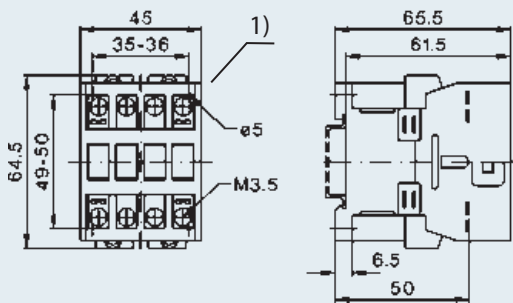

K3-24...
K3-32...
K3-40...

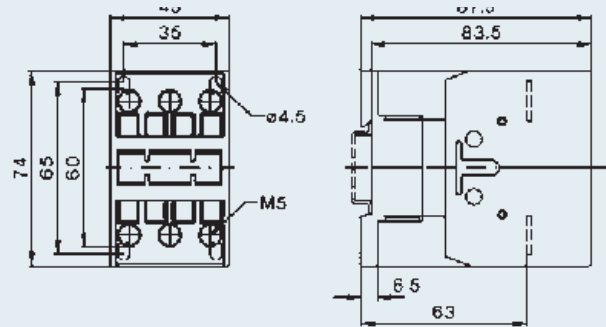

1) Minimum side clearance to conductive parts at coil voltages:

500 V	$U_{imp} = 6 \text{ kV}$	2 mm
660-690 V	$U_{imp} = 8 \text{ kV}$	4.5 mm

K3-50...
K3-62...
K3-74...

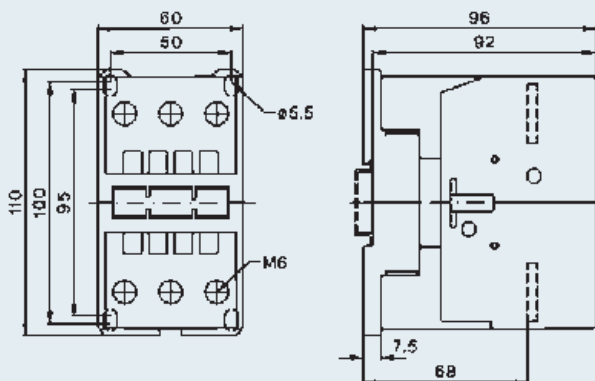

K3-90...
K3-115...

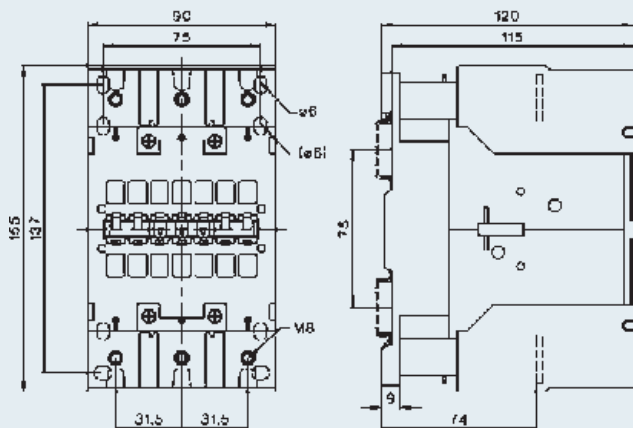

Capacitor contactors for switching detuned and not detuned (without filter reactors) compensation systems with early make contacts

K3-18NK...

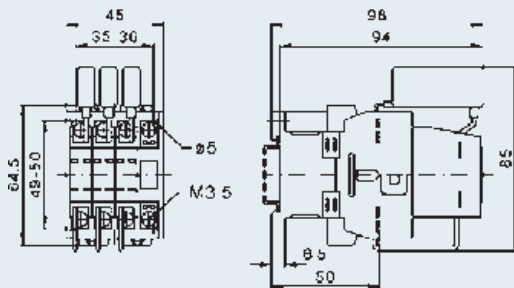

K3-24K...
K3-32K...

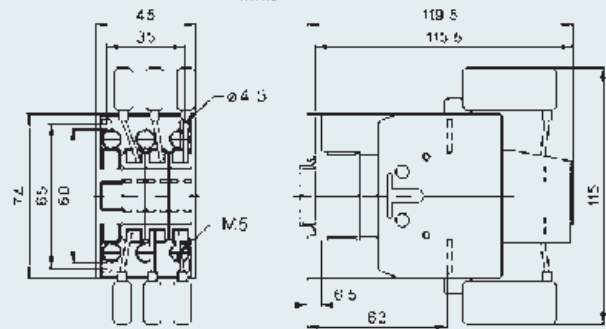

K3-50K...
K3-62K...
K3-74K...

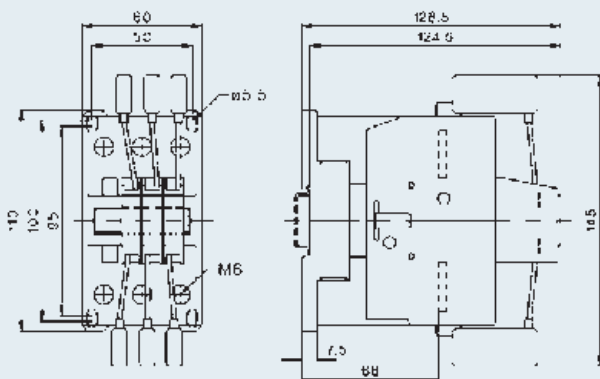

K3-90K...
K3-115K...

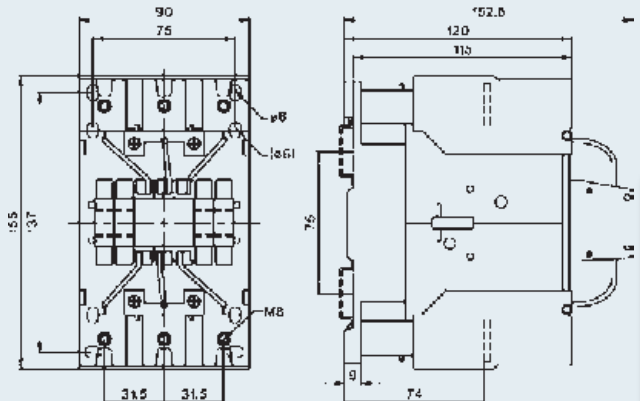

thyroswitch 2P

Current

70 – 115 A



Three-phase thyristor switch with two thyristors

- Highlights**
- Unlimited switching frequency without load on capacitors
 - No peak inrush current when switching on capacitors
 - Short switching delay
 - Compensation almost in real time
 - No operating noise

An overview of the **technical details** is provided on pages 56-57.

The **thyroswitch 2P** 3-phase thyristor switch is a ready-to-install compact unit with which you can connect and disconnect untuned and detuned capacitors quickly and without wear and tear. thyroswitch offers significant advantages over standard contactors.

Among other things, the load on the capacitors is reduced by controlled switching, which increases their operating life. When switched on, there is no peak inrush current and no wear and tear on the switch contacts.

The thyroswitch is controlled via the **multicomp** reactive power controller or directly via the machine control. thyroswitch 2P has two thyristors which switch phases L1 and L3. Phase L2 is connected but not switched on. If the switch-on procedure is activated via a reactive power controller or a control, a voltage comparison between the capacitor voltage and the mains voltage is made. If there is a slight difference, the stage is switched on.

Specifications

DEVICE TYPE	ITEM NUMBER	VOLTAGE in V	FREQUENCY in Hz	CURRENT in A
thyroswitch 2ph-400-50-90	14338	400	50	90*
thyroswitch 2ph-400-60-90	14339	400	60	90
thyroswitch 2ph-400-50-115	14340	400	50	115*
thyroswitch 2ph-400-60-115	–	400	60	115
thyroswitch 2ph-500-50-70	14341	500	50	70*
thyroswitch 2ph-500-60-70	14342	500	60	70
thyroswitch 2ph-240-60-90	14343	240	60	90

* Standard

thyroswitch 2P

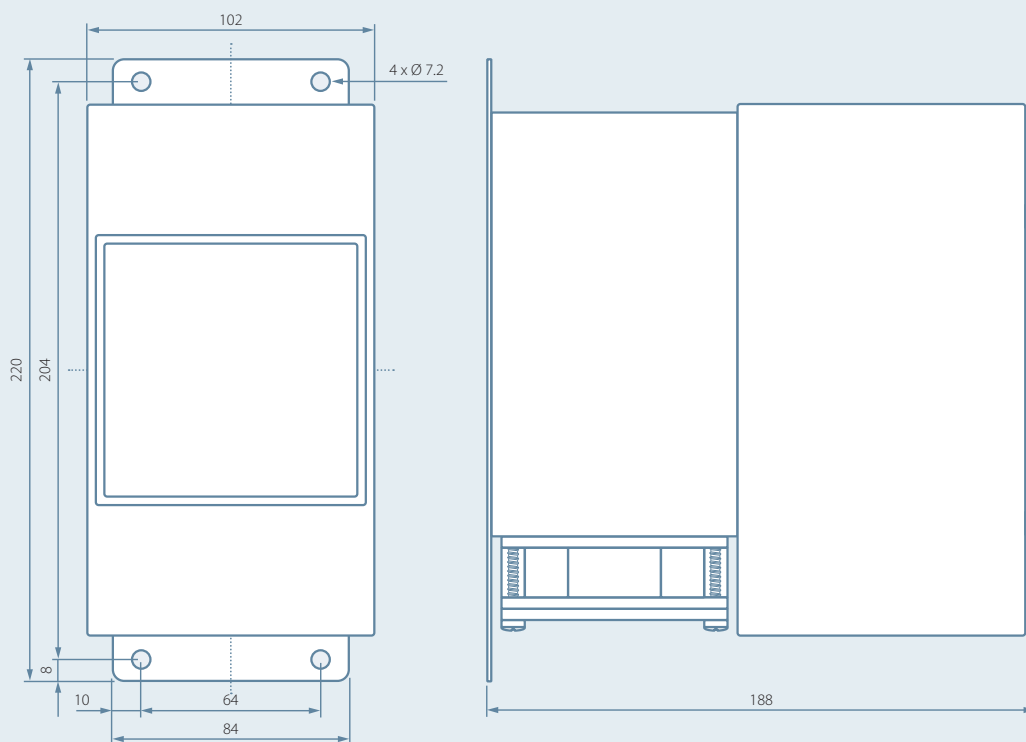

All dimensions are in mm. Not suitable for measurement purposes.

thyroswitch 3P

Current

70 – 100 A



Three-phase thyristor switch with three thyristors

- Highlights**
- Unlimited switching frequency without load on capacitors
 - No peak inrush current when switching on capacitors
 - Short switching delay
 - Compensation almost in real time
 - No operating noise

An overview of the **technical details** is provided on pages 56-57.

The **thyroswitch 3P** thyristor switch combines functional features that already stand out in the thyroswitch 2P: quick and wear-free connection and disconnection of capacitors, unlimited switching frequency with short switching delay and compensation almost in real time. The device generates no operating noise at all and has a compact design ready for connection.

thyroswitch 3P has three thyristors that switch separately or together. If the switch-on procedure is activated via a reactive power controller or a control, a voltage comparison between the capacitor voltage and the mains voltage is made. If there is a slight difference, the stage is switched on.

Specifications

DEVICE TYPE	ITEM NUMBER	VOLTAGE in V	FREQUENCY in Hz	CURRENT in A
thyroswitch 3ph-690/400-50-100	14344	690/400 Y/Δ	50	100*
thyroswitch 3ph-690/400-60-100	14345	690/400 Y/Δ	60	100
thyroswitch 3ph-690/500-50-70	14346	690/500 Y/Δ	50	70
thyroswitch 3ph-690/500-60-70	14347	690/500 Y/Δ	60	70

* Standard

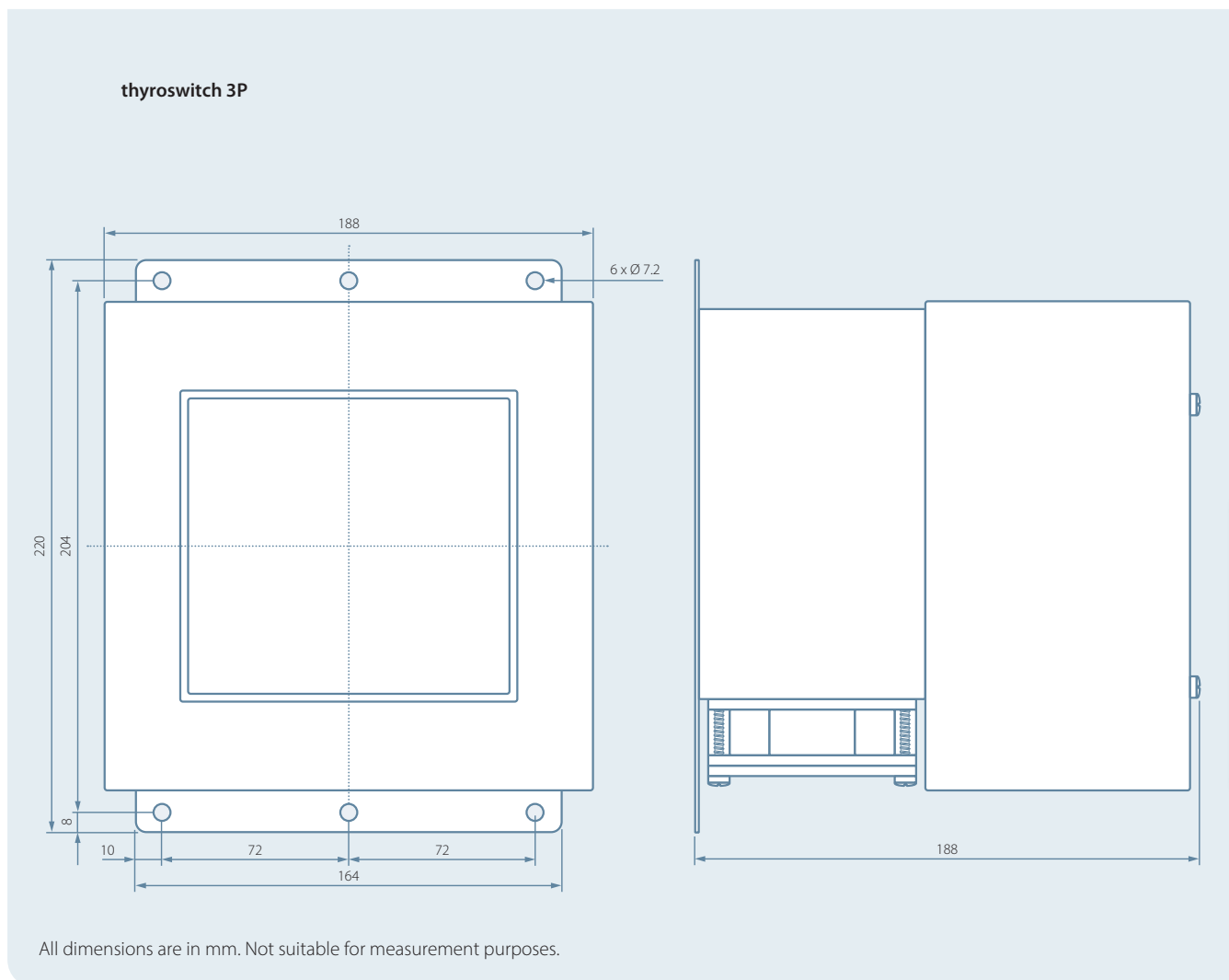

thyroswitch Technical details

DEVICE TYPE

INPUT	Control input
	Fuse protection
POWER SUPPLY	Auxiliary voltage
	Fuse protection
LOAD CIRCUIT	Connection voltage U_N
	Load current
	Power dissipation
FIELD OF APPLICATION	Creepage distances from control input to power circuit
	Rated voltage
	Harmonic voltage
ON DELAY: TURN-OFF TIME > 5s	Input
RECLOSURE DELAY: CYCLIC OPERATION	Input
ELECTRICAL SAFETY	Standards and subsequent amendments
	Protection class
	Clearances
	Protection type
AMBIENT CONDITIONS	Standards and subsequent amendments
	Air humidity, non-condensing
	Operating temperature
	Storage temperature
INSTALLATION	Installation position
	Cooling clearances
HOUSING	Sizes in mm (H x W x D)
WEIGHT	

thyroswitch 2P	thyroswitch 3P
10 – 30 V DC max. 30 mA 180 – 260 V AC 50/60 Hz max. 20 mA	10 – 30 V DC 3 inputs, max. 30 mA each
max. 6 A	max. 6 A
230 V AC 50/60 Hz max. 18 VA	230 V AC \pm 10% 50/60 Hz max. 35 VA
max. 6 A	max. 6 A
400/500 V 50/60 Hz (type-dependent → table)	Δ 400 V/50 Hz Y 690 V/50 Hz
70/90/115 A (type-dependent → table)	max. 100 A
70 A type approx. 2.2 W per A 90/115 A type approx. 2.1 W per A	70 A type approx. 3 x 1.1 W per A 100 A type approx. 3 x 1.05 W per A
> 10.5 mm for SELV voltages	> 10.5 mm for SELV voltages
$U_N \pm 10\%$	$U_N \pm 10\%$
DIN EN 61000-2-4 Class 3 THD max. 10%	DIN EN 61000-2-4 Class 3 THD max. 10%
DC: 0 up to max. 20 ms AC: 10 up to max. 30 ms	0 up to max. 20 ms
DC: 0 up to max. 33 ms AC: 10 up to max. 43 ms	0 up to max. 33 ms
I EN61010:2001 for contamination degree II measurement category III	I EN61010:2001 for contamination degree II measurement category III
IP 10	IP 10
DIN EN 60721-3-3/A2 (3K5 + 3Z11) EC 721-3-3 (3K5 + 3Z11)	DIN EN 60721-3-3/A2 (3K5 + 3Z11) IEC 721-3-3 (3K5 + 3Z11)
5% to 95%	5% to 95%
-5°C to +55°C → Observe the performance limitation depending on the ambient temperature.	-5°C to +55°C
25°C to +70°C	-25°C to +70°C
vertical or horizontal	vertical or horizontal
min. 50 mm to the fan and min. 150 mm to the heat sink outlet	min. 50 mm to the fan and min. 150 mm to the heat sink outlet
220 x 105 x 185 mm 220 x 105 x 198 mm (type 115 A)	220 x 182 x 188 mm
approx. 2900 g approx. 3600 g (type 115 A)	Approx. 5800 g

The KBR system

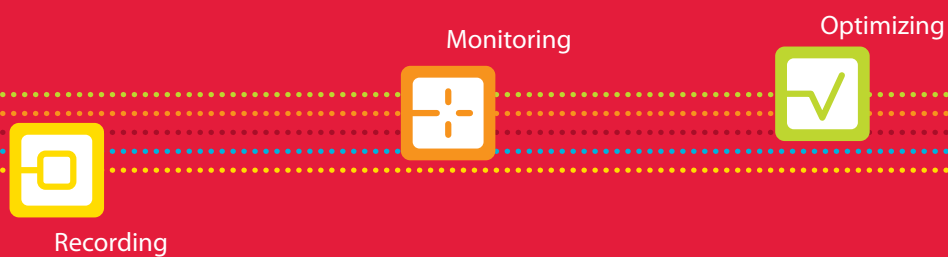

Recording, monitoring, analyzing, optimizing and evaluating: With a perfectly coordinated range of products, KBR offers solutions for all central tasks demanded of contemporary energy management.

Energy efficiency solutions by KBR

Signal recording

Energy measurement technology

Visualization

Power Quality

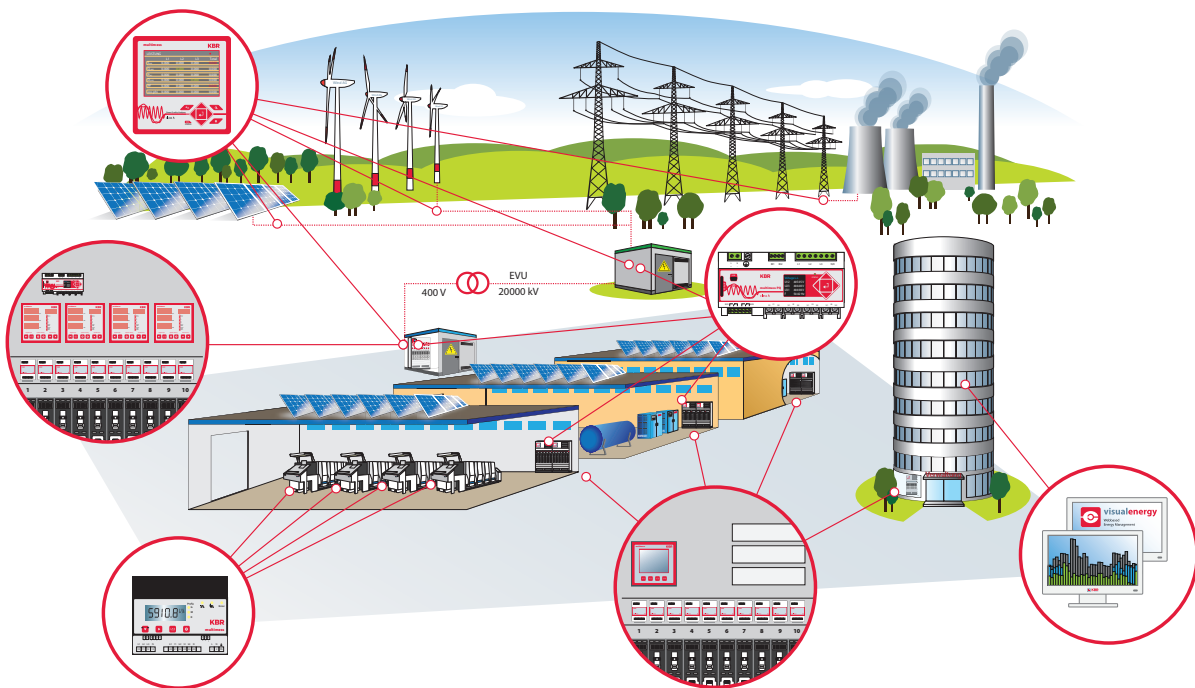

www.kbr.de



THE MULTIMESS EXCELLENCE: MEASURE, MEASURE, MEASURE AND MORE ...



Comprehensive range of applications
Be it as a stand-alone device or in a system – multimesse is a superior multi-meter available in several performance classes.

- V** Voltage
- A** Current
- T** Active power
- Q** Reactive power
- S** Apparent power
- kWh** Consumption
- cosφ** Power factor
- Harm. U** Harmonics
- Load profiles
- Hz** Frequency
- Limits
- Maximum values
- +** ... and many more parameters

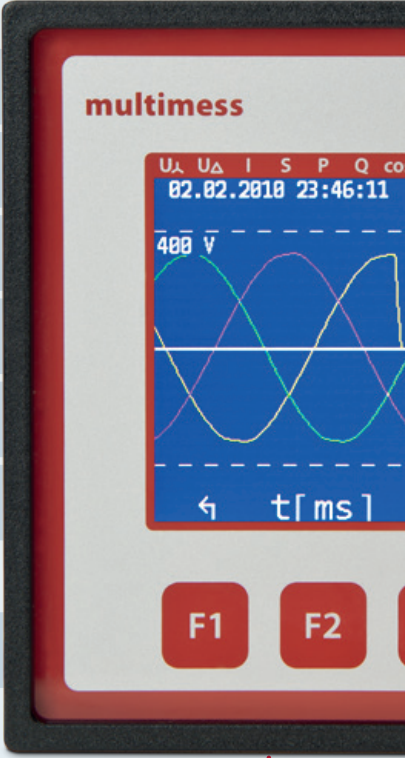

Future-proof technology
High precision and performance in "made in Germany" quality offer the best conditions for modern energy management.

With our energy measuring devices, efficient energy management is very easy. We will be happy to advise you personally.

Product consulting:
+49 (0) 9122 6373-0
info@kbr.de

Capturing and documenting energy data has never been easier.

Whether it be standard and consumption values, load profiles or network quality according to applicable standards: multimes energy measuring devices meet the most diverse requirements with the highest level of safety and precision.

Flexible interfaces

The bus compatibility and load profile memory create the basis for efficient energy monitoring and safe power networks.

Comfortable monitoring

Easy monitoring, evaluation and control of all captured energy data with the web-based **visual energy analysis software**

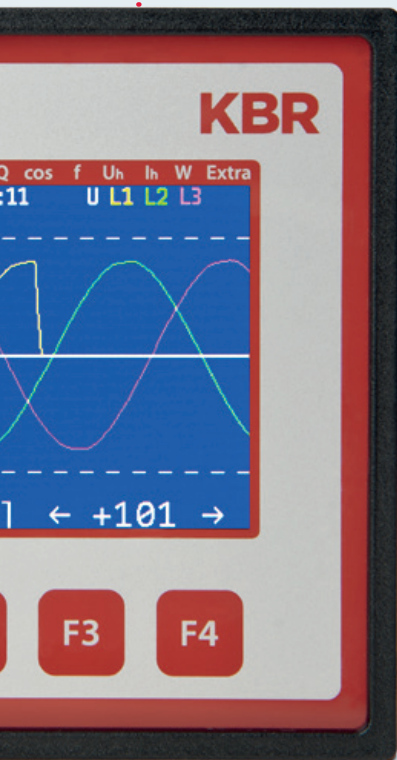

Intuitive operation

Clear, functional user interface design and LED or color TFT displays provide a good overview and easy operation.

Find out about our product portfolio in our catalogs.

www.kbr.de/de/download-center/brochures



THE MULTISIO SPECIALTY: RECORD WHATEVER YOU CAN MEASURE.



multisio Erweiterungsmodule

Flexible expansion

With the **multisio expansion modules**, you can easily adapt the system's functionality to your company-specific requirements.



Energy consumption



State detection



Analog values



Current



Heat, cryogenic power



Gas



Water



Compressed air



Operating hours



And more ...

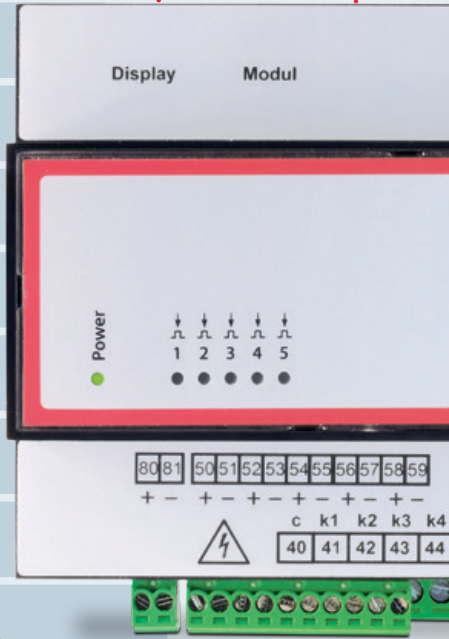

multisio Speicherzentrale

Unlimited measurement

You can easily record and process different states, media and energy types such as water, gas, current, heat or compressed air.



Find out about our product portfolio in our catalogs.

www.kbr.de/de/download-center/brochures

The strength of multisio: recording, documenting and evaluating many different energy types, consumption values and states. With numerous functions and interfaces, the highly flexible system consisting of a storage center and expansion modules makes any measurement task easier.



multisio Display

Measured value display

With the (optional) display, measured values can be conveniently displayed on site.



Decentralized system

The bus-compatible **multisio central unit** is the core of the multisio system. In a decentralized setting, you can connect up to five expansion modules to it.

Real-time control

With the **visual energy** energy management software, you can conveniently visualize, analyze and optimize all of your measured data.

VISUAL ENERGY: EASY AND SAFE ENERGY DATA CONTROL.



ENERGY RECORDING

- Modern energy data management in accordance with **ISO 50001**
- **Seamless recording** of all consumption, types and states of energy
- **100% plausible measurement** in accordance with the **BDEW Metering Code** and **VDE application rule**
- **MSCONS format** for future-proof data import and secure communication with energy suppliers, mains or meter point operators

ENERGY VISUALIZATION

- Continuous **visual analysis process** from data preparation to evaluation
- Comprehensive selection of custom and premade **diagrams** and **reports**
- Easy to create **meaningful key figures**
- **Favorites** for custom organization of the system: practical for direct access to the essentials
- **Interactive dashboards** for a fast and comprehensive overview



KBR Online-Service: Current information about visual energy, downloads and much more can be found at visualenergy.de

The web-based software visual energy provides comprehensive functions for transparent and efficient energy management. A wide variety of energy information from networks and plants can be easily collected, monitored easily recorded, monitored, analyzed and processed. In this way network quality, supply structure and energy costs are always in view.

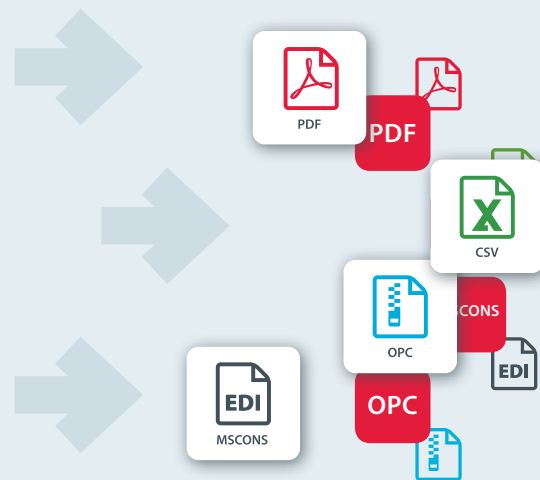

ENERGY MANAGEMENT

- User-defined **workflows** and **favorites**
- **Automatic monitoring** of network quality, consumption values, projected energy volumes and device parameters
- Additional security with **active early-warning system** and monitoring of outgoing fuses
- **reports** and **measures** for efficient control
- Reliable for **third-party quantity limitation** and **residual current measurements**

ENERGY EVALUATION

- **SEU reports, regression analysis, Sankey diagrams, heat maps, filter analysis and much more**
- **Individual key figures** with your production data integrated
- Standardized **report preparation**
- Secure data export in common data formats, such as **PDF, CSV, MSCONS** or **OPC**
- New **unlimited user administration**



Find out about our product portfolio in our catalogs.

www.kbr.de/de/download-center/brochures

THE MULTIMAX FACTOR: HIGHLY FLEXIBLE AND EXTREMELY EFFICIENT.



Modular system

With the **multimes** and **multisio** modules, you can expand the load management system to control up to 80 consumers.

- Electricity
- State detection

- Gas
- Electrical power

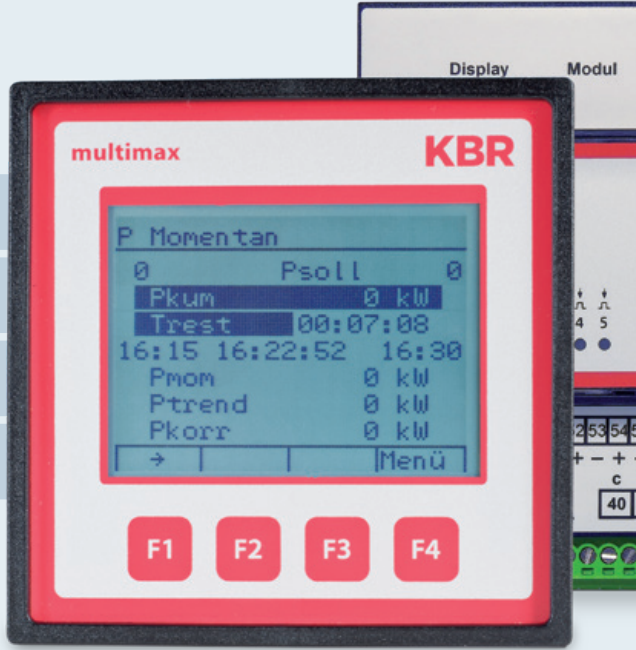

Basisgerät multimax D6 mit Display multimax F96-D5

Intelligent functions

Target value and instantaneous value monitoring, target value tracking, prewarning contact (alarm), timer programs, emergency shut-down, and much more.

Energy optimization is an important aspect of modern energy management. We will be happy to advise you personally.

Product consulting:
+49 (0) 9122 6373-0
info@kbr.de

The key to successful energy optimization is the perfect coordination of reliable product technology and flexible load control. The multimax energy optimization system can be adapted to plants of any size due to its modular design.

Visualization

The **multimax IGW** is integrated into the network and runs immediately via Plug and Play, without installing any software. Analysis and programming can be performed from any PC with a default browser.

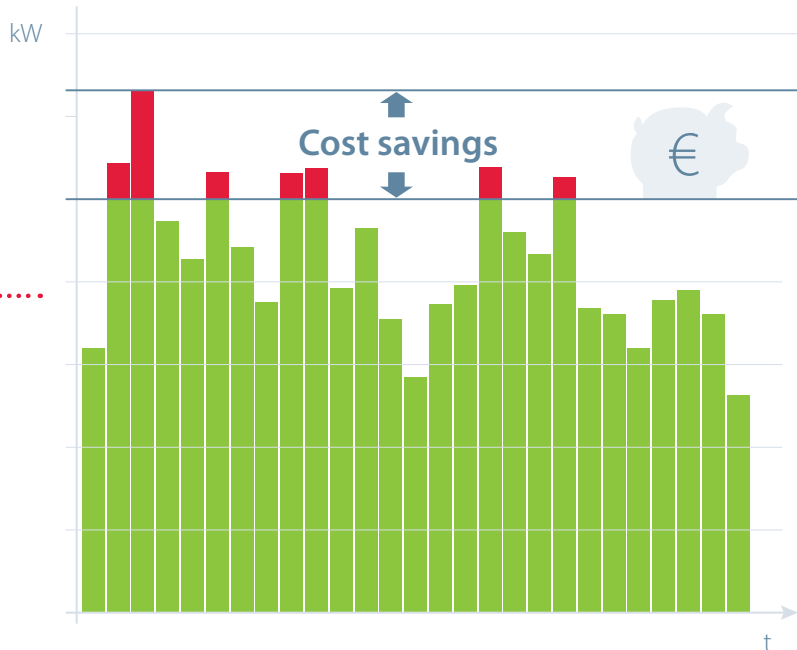
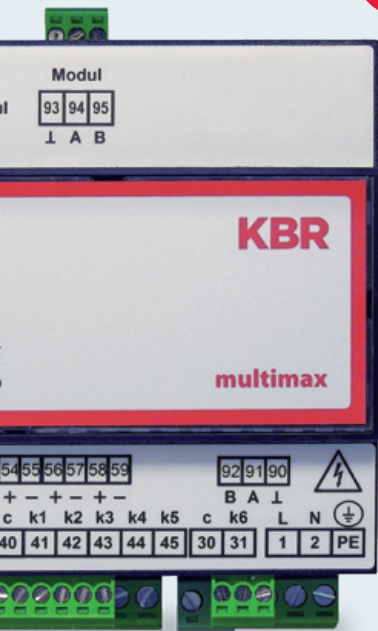

Meter inputs with pulse totalizer function

multimax D6 can capture the values of up to 5 meters. You can connect additional meters with the **multisio D2-4DI** module.

Use the enormous savings potential wisely with our energy flow and consumption optimization measures.



Find out about our product portfolio in our catalogs.

www.kbr.de/de/download-center/brochures

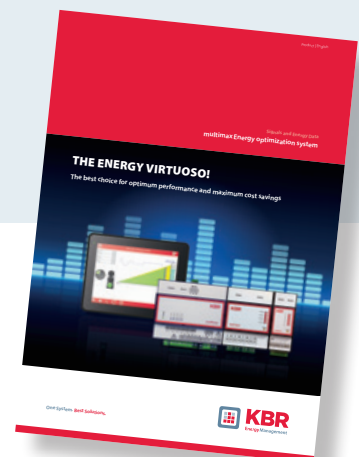

multiwave active: THE MULTITALENT FOR ALL DISTURBANCE PATTERNS.

Whether harmonics, load unbalance or reactive power – one device for all requirements.

Easy expansion due to modular design

Control current or voltage controlled

Minimal maintenance effort

Filtering up to 51. harmonic

Simple and fast commissioning



...and much more



multiwave active operates completely digitally and intelligently

The flexibility of the **multiwave active** is shown by the fact that the filter can be coupled to the power grid on the load or grid side and can be controlled by current or voltage. Once configured with a few clicks, the instantaneous mains current is measured permanently and occurring harmonics, load unbalance, reactive power as well as phase shifts are actively compensated. In microseconds, the **multiwave active** calculates the compensation currents for this and feeds them into the grid. Via the display, commissioning, selection and setting of individual parameters is very user-friendly.

With the right partner to an individual system

To find the best network quality solution for your business and facility, KBR's expert **Power Quality Service** is available to help: From consulting to network analysis and planning, to implementation and after-sales support. To say **multiwave active** has clearly improved your power quality efficiency.



Find out about our product portfolio in our catalogs.

www.kbr.de/de/download-center/brochures



Control both current and voltage controlled or both at the same time

Due to its individual control, the **multiwave active** adapts to any network and any requirement. All three control modes have their advantages.

Current-guided:

- Only one device is to be compensated
- Design via current spectrum
- Network symmetries
- Optimum utilization of transformer and cable
- Reactive power factor correction 50 Hz

Voltage guided:

- Control to the standard limits
- Adheres to the standard limits at the connection point of the filter
- High voltage distortion from medium voltage
- Compensation of small or high-frequency harmonic levels
- No installation of current transformers necessary

Combination:

- Compensation of low-frequency harmonics via current control, higher-frequency harmonics via voltage control. Thus, optimal utilization of the filter.

THE MULTICT FAMILY: THE RIGHT TRANSFORMER FOR EVERY MEASUREMENT TASK.



Bushing type current transformer – multict ASK

Compact construction for use with circular conductors and busbars.



Bushing type current transformer – multict CTM7

For installing in distribution measurements with low space for installation.



Bushing type current transformer – multict CTB

Bushing type current transformers with “Cage Clamp®” screwless connection technology, UL-certified.



Core balanced current transformer – multict KBU

Folding transformers for subsequent installation in existing distributions.



Core balanced current transformer – multict KBR

For subsequent installation without separating the primary circuit.



Totalizing current transformer – multict KSU / SUSK

Aggregation of multiple main transformers to connect to one measuring device.

No measuring device without a current transformer. The multict current transformer and the multimes measuring device series form a strong team together!

multimes F144-PQ

multimes F144 LED

multicount D5



multimes D9-PQ

multimes F96 TFI

multimes D4-BS

multimes D6

The current transformers in the multict product group are an essential part of any energy measurement. Along with choosing the right current transformer, this is a significant contributing factor in the accuracy of measured values.

The high measuring quality is a prerequisite to establishing a plausible energy ata management system and evaluating the network quality.



**Rogowski coil –
multict FASK**

The alternative when there's no space for the current transformer.



**Measurements up to 20 kHz –
multict XCTB / XKBU / XKBR**

Guarantee highly precise signal transmission up to 20 kHz. Ideal in combination with the multi-mess D9-PQ power quality analyzer.



**Bushing type current transformers for billing purposes –
multict EASK**

With PTB design approval for establishing a measuring point, which is needed for billing.



**Bushing type current transformers,
"Cage Clamp" screwless connection
for billing purposes – multict ECTB**

With PTB design approval for establishing a measuring point, which is needed for billing.



**Totalizing current transformers
for billing purposes –
multict EASK**

With PTB design approval for establishing a measuring point, which is needed for billing.



**Residual current transformers –
multict DACT**

For recording the residual current in 3-/4-wire AC networks.

Find out about our product portfolio in our catalogs.

www.kbr.de/de/download-center/brochures



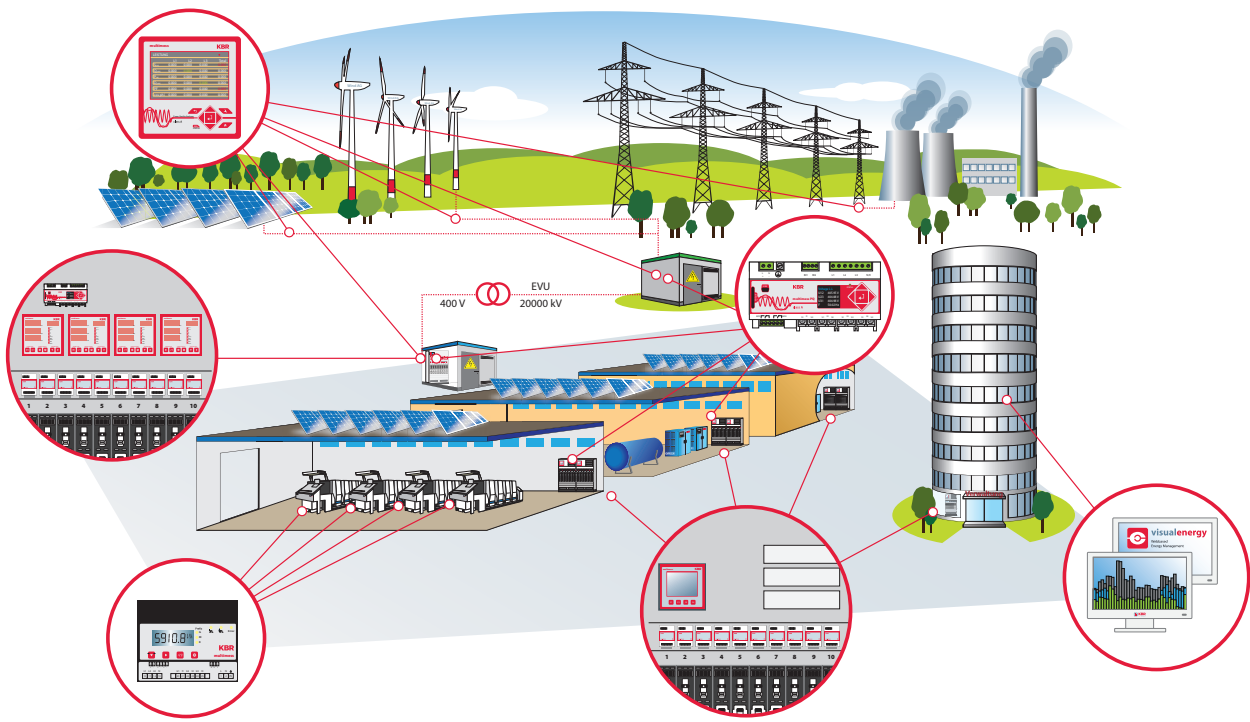

Cost savings through increased efficiency

Our solutions for contemporary energy management.

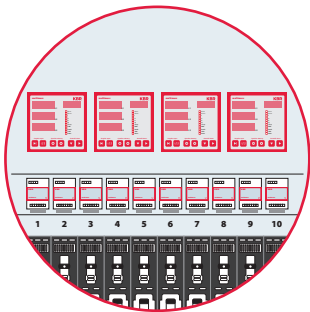

When measurement alone is not enough.

Capturing and documenting energy data has never been easier. Standard and consumption values, load profiles or easily recording countless forms of energy, media, and states – our measuring devices meet the most diverse requirements with the highest level of safety and precision.



We make energy visible

With its impressive functionality, visual energy allows for transparent and efficient energy management. You can easily capture, monitor, analyze and process the most diverse energy information from networks or systems. This helps you track your energy costs.

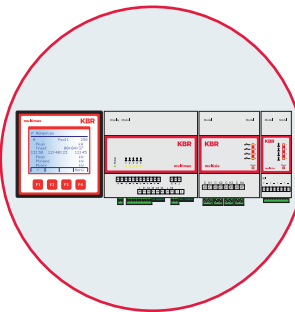

Intelligent load distribution that pays off in several ways

The key to successful energy optimization is the perfect coordination of reliable product technology and intelligent load control. With its system architecture and comprehensive functionality, the system is highly efficient for the most diverse applications.

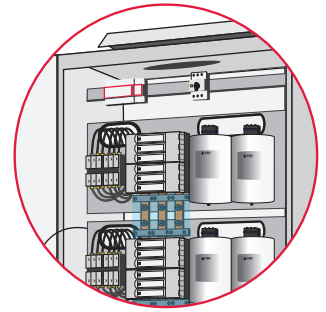

Spot-on network quality

The use of compensation systems does not only reduce the reactive current costs but also the load on a company's lines and distributions. Intelligent controllers, innovative components, as well as the perfectly matched construction considerably increase the operating life as well as your profit.

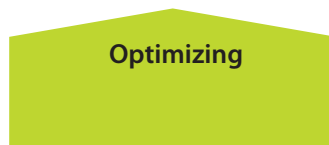
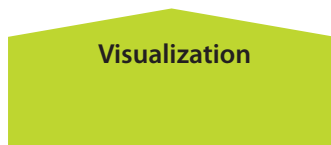

Our offers...

- lowering energy costs
- increasing operational safety
- from planning to realization - all from one source
- top quality "Made in Germany"
- high production depth
- factory service center hotline
- innovative system solution
- in-house engineering
- TÜV certified energy data management software
- contribution to protect the environment

KBR provides impulses and smoothes the way...



www.kbr.de

© Copyright
by KBR GmbH

KBR Kompensationsanlagen-
bau GmbH
Am Kieferschlag 7
D-91126 Schwabach, Germany
Phone +49 (0) 9122 6373-0
Fax +49 (0) 9122 6373-83
E-mail info@kbr.de

KBR makes the difference!

PRODUCTS AND SOLUTIONS
FOR CONTEMPORARY
ENERGY MANAGEMENT

MADE IN
GERMANY

Product consulting:
+49 (0) 9122 6373-0
info@kbr.de

**Need more
information?**
We will be happy to
advise you personally.

FOR YOU. ON SITE WORLDWIDE.





With a few clicks to the contact data of our partners:
www.kbr.de/en/contact/sales-partners

KBR provides you a dense network of quality and experienced business partners.

KBR DISTRIBUTION AND SERVICE POINTS:

Austria	France	Kenya	Poland	Thailand
Belgium	Greece	Malaysia	Saudi Arabia	Turkey
Bosnia-Herzegovina	Guatemala	Malta	Serbia	United Arab Emirates
Czech Republic	Hungary	Mexico	Singapur	Ukraine
China	Ireland	Netherlands	Switzerland	
Denmark	Jordan	New Zealand	Taiwan	

KBR is your reliable energy management partner.
With precision technology, efficient solutions and a comprehensive range of services, the KBR system helps companies from the plant engineering, industry or craft sector maintain their technical edge.
For a sustainable and future-proof energy supply.

Our services:

- Planning and consulting
- Energy measuring devices
- Analysis software
- System integration
- Seminars & workshops
- First-class services from one source



KBR Kompensationsanlagenbau GmbH

Am Kieferschlag 7
D-91126 Schwabach,
Germany

T +49 (0) 9122 6373-0
F +49 (0) 9122 6373-83
E info@kbr.de

www.kbr.de