



User manual Technical parameters

multimes

Three-phase network measuring device

F144-2-LED-...-5



**Your partner for
network analysis**

1	Device memory.....	8	9.2	U_{Ph-Ph} - measuring reference voltage/rated mains voltage.....	27
2	Definition of terms.....	9	9.3	I - Current transformer ratio	28
3	Default settings after a reset (delivery state)	10	9.4	I_N - Current transformer ratio	29
4	Setting range	11	10	Display functions.....	31
5	Field of application/range of functions	13	10.1	U_{Ph-N} - Voltage phase to neutral conductor, frequency	31
6	Connecting the multimes F144-2-LED-...-5	15	10.2	U_{Ph-Ph} - Voltage phase to phase, rotary field display	32
6.1	Installation and assembly	15	10.3	I/I_N - Current/neutral conductor current, I_{PE} (PE – leakage calculated), instantaneous- average value switching	33
6.2	Installation	15	10.4	S - Apparent power/total apparent power	35
6.3	Connection diagram	18	10.5	P - Active power/total active power	36
6.4	Terminal assignment.....	20	10.6	Q - Reactive power/total reactive power.....	37
7	Control and display panel.....	22	10.7	$\cos \varphi$ - Fundamental power factor, PF, total PF	38
7.1	Description of sensor buttons and displays	23	10.8	kWh - Active energy HT/LT consumption and recovery, maximum cumulated cycle active power	39
8	Operation.....	24	10.9	kvarh - Reactive energy meter HT/LT consumption and recovery, maximum cumulated cycle reactive power.....	41
8.1	Menu structure of the multimes F144-2-LED-...-5	24	10.10	THD- distortion factor and partial harmonic content of the voltage and current network harmonics.	43
8.2	Navigation and device displays..	25	10.11	Extra	44
9	Setting the operating parameters.....	26	10.12	Maximum/Minimum extreme values display.....	49
9.1	General programming scheme... 26		10.13	Displaying limits	52
			11	Programming.....	55
			11.1	Period time current average value	55

11.2	Tariff switching method.....	56	13.1	Device settings.....	84
11.3	Measurement period synchronization	57	13.2	Basic device parameters	84
11.4	Programming limits.....	58	13.3	Load profile memory	85
11.4.1	Configuring hysteresis for limits.	60	13.4	Annual energy memory.....	85
11.5	Setting time and date.....	62	13.5	Event memory/operation logbook.....	86
11.6	Setting the bus address	63	13.6	Measurement period synchronization	86
11.7	Setting the bus protocol.....	64	13.7	Synchronization only by internal clock.....	86
11.8	Setting the Modbus bus address and baud rate	65	13.8	Synchronization by the energy supplier's synchronous pulse.....	87
11.9	Setting the relay on-delay and off-delay.....	66	13.9	Synchronization by KBR eBus	87
11.10	Activating daylight saving time..	68	13.10	Synchronization at tariff change	88
11.11	Language settings	69	14	Technical data.....	89
11.12	Password	70	14.1	Measuring and display values	89
11.13	Configuring the pulse output.....	71	14.2	Measurement accuracy class (in accordance with DIN EN 61557-12).....	91
11.14	Damping coefficient	73	14.3	Measuring principle	91
11.15	Default settings.....	74	14.4	Device memory.....	92
11.16	Zero point creator	75	14.5	Power supply	92
11.17	Analog outputs (option).....	76	14.6	Hardware inputs and outputs	93
11.18	Key sounds (button buzzer)	80	14.6.1	Inputs.....	93
11.19	Default menu (start selection).....	81	14.6.2	Outputs.....	93
12	Reset and delete function	82	14.7	Electrical connection	94
12.1	Reset	82	14.8	Mechanical data	95
12.2	Delete energy meter	82	14.9	Ambient conditions, electrical safety and standards.....	96
12.2.1	Delete energy meter manually ...	82	15	Serial interface	97
12.2.2	Delete all energy meters	82	15.1	RS 485 bus operation.....	97
12.3	Deleting extreme values	82	16	Overvoltage and lightning protection	97
12.3.1	Deleting individual extreme values.....	82	17	Troubleshooting	98
12.3.2	Deleting all extreme values.....	83	18	Appendix.....	100
12.4	Deleting limit settings.....	83	18.1	Added functionality: Profibus....	100
12.4.1	Deleting individual limit settings	83	18.2	Setting the bus protocol.....	100
12.4.2	Deleting all limit settings	83			
13	Memory functions	84			

Dear customer

Thank you for choosing a KBR product.

To familiarize yourself with the operation and configuration of the device, we recommend that you read this manual carefully. This will enable you to make use of the full range of functions that this high-quality product has to offer.

The individual chapters explain the technical details of the device and show you how to install and start it up properly to avoid damage.

This user manual is included in the scope of delivery of the device and must be accessible to the user at all times (e.g. in the switchgear cabinet). Even if the device is resold to third parties, the manual remains an inherent part of the device.

Although the utmost care has been taken in writing this user manual, errors may still occur. We would be very grateful if you would notify us of any errors or unclear descriptions you may notice.

Yours sincerely,

KBR GmbH Schwabach

This manual contains notes that must be observed for your personal safety and to prevent damage to the equipment. These notes are identified by a warning sign or information symbol, depending on the degree of hazard they warn about.



DANGEROUS VOLTAGE

This means that death, serious physical injury or considerable property damage will occur if the appropriate safety precautions are not taken.



CAUTION

This means that minor physical injury or property damage may occur if the appropriate safety precautions are not taken.



NOTE

This is an important piece of information about the product, the handling of the product or the relevant part of the user manual to which particular attention should be drawn.

Disclaimer

The contents of this document have been checked using the hardware and software described. Nonetheless, deviations cannot be ruled out, and the manufacturer cannot guarantee 100% conformity. The information provided in this manual is checked on a regular basis; any corrections necessary will be included in the next revision.

We appreciate your corrections and comments.

Safety instructions

In order to prevent operating errors, handling of the device has been kept as simple as possible. This will enable you to start use the device quickly. Be sure to carefully read the following safety instructions.

**DANGEROUS VOLTAGE****The applicable DIN/VDE regulations must be observed during installation!**

Connection to the mains, commissioning and operation of the device may only be carried out by qualified personnel. Qualified personnel as defined in the safety instructions in this user manual are personnel with electrical engineering qualifications, knowledge of the national accident prevention regulations and safety engineering standards as well as of the installation, commissioning and operation of the device.

To prevent fire and electric shock, do not expose the device to rain or moisture!

Before connecting the device to the power supply, check whether the local power supply conditions comply with the specifications on the device name-plate.

Incorrect connection may result in the destruction of the device!

When connecting the device, adhere to the information given in the connection diagram (see "Connection diagram") and that the connecting cables are not live. When wiring, always ensure that all cables used are neither damaged nor faulty

and observe correct polarity!

To ensure proper and safe operation of the device, ensure that it is transported, stored, installed, assembled, and carefully operated and maintained in accordance with the specifications.

If the device has any visible damage it is considered unfit for use and must be disconnected from the power supply! Troubleshooting, repairs and maintenance work may only be carried out at our plant or after contacting our customer service team.

Unauthorized opening of the device will render your warranty null and void. Correct functioning can no longer be guaranteed!

Opening the device may expose live parts. Capacitors in the device may still be charged, even if the device has been disconnected from all power sources. Do not operate open devices under any circumstances!

Systems that are at risk from lightning strikes must be fitted with lightning protection for all input and output cables (see chapter "Overvoltage and lightning protection" for recommendations)!

Do not connect external power sources to terminals 36-39, 60-63 or 90-92. Only apply safe-to-touch extra-low voltage in accordance with UL/CSA/IEC 61010-1 to terminals 34 and 35. See technical data for maximum values.

Product liability

You have purchased a high-quality product.

Only components of the highest quality and maximum reliability are used.

Each device is subject to long-term testing before delivery.

For details on product liability, please refer to our general terms and conditions for electronic equipment.

The assured device properties only apply if the device has been operated in accordance with its intended use!

Disposal

Devices that are faulty, obsolete or no longer used must be properly disposed of.

If required, we will dispose of the device for you.

Scope of delivery

Included in the scope of delivery:

- Measuring device
- Connector set
- Quick guide
- Mounting material for the housing

1 Device memory

The device is equipped with internal data memory (flash). After uninterrupted charging (device connected to the power supply) for approx. 100 hours, the buffer capacitor will have sufficient charge to protect the internal clock from failure due to disconnection from the power supply for approx. 7 days.



NOTE

If the capacitor is discharged and it is not connected to a power source, the time settings will be lost and will need to be reset!

2 Definition of terms

Below, you will find a brief explanation of the terminology used in this manual.

RMS value (root mean square value): According to its definition, an effective value is the RMS value of an alternating or pulsating quantity. Multimes F144-2-LED-...-5 exclusively calculates with effective values of pure alternating quantities (RMS).

Instantaneous RMS value: The value determined by the multimes F144-2-LED-...-5 during its measurement interval.

Measurement interval: During a measurement interval, the electrical quantity "voltage" or "current" of a phase is scanned. The resulting sampling points are available for further calculations. This interval is mainly determined by the A/D conversion.

Measuring cycle: The measuring cycle is the time the measuring device needs in order to measure all the values recorded by the device for all three phases.

Firmware: The operating system implemented in the microcontroller of the multimes F144-2-LED-...-5.

Load profile memory: Saves the actual values of the measurement periods with timestamp.

Measurement periods-maxima: The measurement period containing the highest (maximum) value that occurred.

Active/reactive power periods: Actual active or reactive power during a measurement period

Measurement period: The period of time used to determine average power values. Typical intervals: e.g. 1, 15, 30, 60 minutes.

3 Default settings after a reset (delivery state)

Primary voltage/secondary voltage	400 V/400 V
Primary current/secondary current	5 A/5 A
Measuring current averaging time	10 minutes
Primary/secondary neutral conductor	5 A/5 A
Neutral conductor measurement type	Calc (calculated)
Neutral conductor averaging time	10 minutes
Measurement period time	15 minutes
Daylight saving time	from months 03 to 10
Off-peak time	Changeover via bus communication
Damping coefficient for current and voltage	DF 0 (no damping)
Energy pulse	P (active power for consumption), 1 (1,000) pulse /kWh, pulse length 100 ms
Alarm relay	On delay tON = 0 sec Off delay tOFF = 0 sec
Analog outputs	Deactivated
Measurement period synchronization	Internal
Password	9999/all functions can be accessed
Button buzzer	On
Limit hysteresis	01%
Default menu	Deactivated
Start selection	

Unaffected by a RESET:

1. Bus communication
2. Time
3. Language

4 Setting range

The following setting ranges are available for configuration of the unit:

Measuring voltage, primary	1 V to 9999 kV
Measuring voltage, secondary	100 V to 600 V
Measuring current, primary	1 A to 99.99 kA
Measuring current, secondary	1 A or 5 A
Average measuring current and neutral conductor current	Averaging period 1 to 15 minutes
Neutral conductor current, primary	1 A to 99.99 kA
Neutral conductor current, secondary	1 A or 5 A
Neutral conductor measurement type	Calculated (calc) or measured (transformer input)
Measuring current	Auto (automatically 45 to 65 Hz),
Frequency tracking	fixed 50 Hz, fixed 60 Hz
Measurement period time	1, 15, 30, 60 minutes (via - KBR eBus)
Measurement period synchronization	dig. Input, internal clock, KBR eBus, rate changeover
Off-peak time	dig. Input, internal clock, KBR eBus at internal: Starting time hh:mm End time hh:mm
Summer time (start or end)	Month 01 to month 12
Language	German, English
Damping coefficient for current and voltage display	dF 0 (no damping) to 6 (highest damping)
Energy pulse output	Active power or reactive power, each consumption or recovery
Pulse value	0.001 to 9999 Imp/kWh or/kBh
Pulse length	30 to 990 ms
Harmonics limits	0% to 100%
Alarm relay delay	On delay FTS 0 to 254 sec. Off delay FTS 0 to 254 sec.
Password	4-digit number, 9999 means all functions are freely accessible
Time, date	Setting hh:mm, dd:mm:yyyy

Continued

Button buzzer	On/Off
Zero-point creator	On/Off
Bus protocol	KBR - eBus serial, Modbus serial, KBR - eBus TCP, Modbus TCP, Profibus
Bus parameters KBR eBus serial	Scan mode, bus address 1 to 9999
Bus parameters Modbus serial	Bus address 1 to 247; Parity no, even, odd; Bus protocol 19200, 9600, 4800 baud; Transmission type RTU or ASCII
Bus parameters Modbus TCP (optional)	Bus address cannot be changed
Bus parameters KBR eBus TCP (optional)	Scan mode, bus address 1 to 9999
Bus parameters Profibus (optional)	Bus address 1 to 126
Analog interfaces 1 to 3 (option)	Output format: 0 to 20 mA, 4 to 20 mA 0 to 10 volts, 2 to 10 volts. See table for data points "Configuration of analog outputs" (Menu: Extra - Analog outputs). Lower limit, upper limit
Limit hysteresis (in the Limit value configuration submenu)	1% to 99%
Default menu (start selection)	Menu 01 to 11 (U_{PH-N} to Extra), deactivatable (display ----)

5 Field of application/range of functions

The **multimes F144-2-LED-...-5** is an affordable network measuring device for switchboard installation that measures all important parameters in three-phase networks.

The microprocessor of the **multimes F144-2-LED-...-5** records the mains voltage and current consumption of the meter point for all three phases via analog/digital converter inputs and calculates the active, reactive and apparent power ratio in the three-phase network.

Convenient operation and display

The LED Displays L1, L2 and L3 allow you to read the measured values directly and enter the respective parameters and configuration data. In addition, eleven LEDs indicate menus and the status. Six sensor buttons facilitate navigation through the menus.

For 100 to 400 V networks

The **multimes F144-2-LED-...-5** can be used in 3-wire and 4-wire networks. The device can be used to make measurements directly in 100 V and 400V networks. Higher voltages can only be connected via external voltage transformers, with the primary and secondary voltage being programmable. The measuring voltage inputs of the device measure directly, i.e. they are not galvanically separated by a voltage transformer!

For energy supply networks with an outer conductor to ground potential, suitable ballasts with electrical isolation must be used, e.g. voltage transformers or zero point creators.

x/5A or x/1A freely programmable

The current measurement inputs must always be supplied via current transformers; the transformer ratio is programmable. The primary current value as well as the secondary current value can be selected.

Determining the neutral conductor current

The neutral conductor current is either calculated or measured by an additional connected transformer and shown on the display.

Calculating the PE Leakage

When the neutral conductor current is measured, the PE leakage is calculated and displayed. When the neutral conductor current is calculated, no PE leakage is displayed.

Harmonic analysis

Harmonic analysis by Fourier transform. The **multimes F144-2-LED-...-5** measures the harmonics of the 3rd /5th /7th /9th /11th /13th /15th /17th and 19th to the 63rd voltage network harmonic, calculates their partial harmonic content, the total distortion factor of the voltage and the distortion reactive current.

Two-tariff meter function (HT/LT)

Consumption during high tariff and low tariff times is recorded separately. Switching from high to low tariff times and vice versa is either carried out by means of a digital signal to be applied externally, e.g. from the energy supplier, or via an internal clock. When operated with the KBR eBus, switching can be done centrally via the ve-busmaster.

Programmable pulse output

Active energy or reactive energy proportional pulses can be output via a programmable output laid out as an S_0 -compatible interface. The pulse output type (proportional to active or reactive energy) as well as the pulse significance (number of pulses per kWh or per kvarh) and the pulse length can be programmed. These pulses can be processed by, for example, a master system for data acquisition or optimization, a maximum-demand monitor or a central process control.

Serial interface

In its default configuration, the **multimes F144-2-LED-...-5** has a serial interface (RS485) for operation with the KBR eBus or Modbus.

A variety of information that cannot be shown on the display can be read from the device via the bus.

This makes it possible to read numerous online measurement values as well as a wide range of data can from the long-term memory.

Extensive memory functions

In addition to its meter functions, the **multimes F144-2-LED-...-5** offers extensive

memory functions:

- a load profile memory to record the cumulated active and reactive power
- a memory to record the daily energy values for 366 days
- and an event memory/operation logbook that records defined actions of the measuring device, such as power failures, tariff switching actions, delete functions and many more.

These memory functions are only available via the KBR eBus.

Synchronization

To synchronize the load profile memory, a separate digital input was integrated into the **multimes F144-2-LED-...-5** where you can, for example, connect the synchronization signal of the energy supplier's meter. Synchronization as well as switching between high tariff and low tariff can be done centrally via the KBR eBus or the internal clock.

Analog outputs

Various parameters between 0-20 mA or 4-20 mA and between 0-10 V or 2-10 V can be output as analog values.

Depending on which parameter you wish to output (e.g. active power), you can assign a certain phase (L1, L2, L3) or its whole value to the analog output.

Software (optional)

A series of software products that run on most Microsoft® Windows® operating systems

are available for the convenient programming and storage of long-term data.

Separate power supply

The device requires a separate auxiliary voltage for operation.
(see nameplate)

If you have any questions on this device or our software products, please don't hesitate to contact us. It is our pleasure to assist you.

See the end of this user manual for contact details.

6 Connecting the multimes F144-2-LED-...-5

6.1 Installation and assembly

- The applicable VDE regulations must be observed during installation!
- Before the device is connected to the power supply, check whether the local power supply conditions comply with the specifications on the nameplate. A faulty connection can destroy the device.
A different power frequency can also affect the measurement.
- Connect the device in accordance with the connection diagram.
- The power supply input of systems that are at risk from lightning strikes must be equipped with suitable lightning protection.

6.2 Installation

Installation site: The device is designed to be installed in fixed and weather-proof switchboards. Conductive switchboards must be grounded.

Installation position: vertical

Fixing: Using the clamps provided, the device is attached to the switchboard from behind.

**CAUTION**

The control voltage as well as the applied measuring voltage of the device must be protected using a back-up fuse.

When connecting the current transformers, pay attention to the direction of energy flow and the correct assignment to the voltage paths!

Power supply: The electrical installation of the building must have a disconnect or circuit-breaker for the power supply voltage.

The disconnect must be close to the device and be easily accessible to the user.

It must be marked as an isolating switch for this device.

The isolating switch must be UL/IEC-approved.

Voltage measurement:

The disconnect must be close to the device and be easily accessible to the user.

It must be marked as an isolating switch for this device. The isolating switch must be UL/IEC-approved.

**CAUTION**

- Do not apply DC voltage to the voltage measurement input.
- The device is not suitable for DC voltage measurement.
- Attach the current transformer terminal to the device using the two screws provided.
- Never operate open external unloaded current transformers. Always short-circuit them. Risk of injury due to high voltages and electrical currents.

For the wiring of the pulse output, we recommend that you only use shielded twisted pair cables to avoid interference (e.g. installation line I-Y(ST) Y 2 x 2 x 0.8 mm², with the shielding only connected on one side).

During installation, please also observe our notes on safety measures against overvoltage and lightning in the chapter "Overvoltage and lightning protection" of this manual.

**NOTE**

The following points must be taken into account when connecting the device to the three-phase network you want to measure:

- Direction of energy flow
- Assignment of measuring voltage input/current transformer input

Rotary field:

The device can be operated with a clockwise or anti-clockwise rotary field. When switching on the device power supply, the multimes F144-2-LED-...-5 automatically checks the direction of rotation. Rotary field check:

- Only connect the measuring voltage to the device (U_{meas} see nameplate).
- Switch the device on by connecting the power supply cable voltage to the power supply connections (L and N). The device checks the power supply's direction of rotation immediately after being switched on.
- The rotary field is displayed in the in the Rot.field submenu of the U_{PH,PH} menu.
- For a clockwise rotary field, the display shows L1 0, L2 120 and L3 240 degrees.
- If you want to change the direction of rotation from clockwise to anti-clockwise, simply swap two terminals, i.e. two phases, then switch the device OFF and ON again. The display now shows the correct voltage and the device starts measuring automatically.
- Check again whether the assignment of the voltage path L1 and the current path L1 as well as all other phases are still correct.

Current transformer connection:

- Direction of energy flow:

When installing the transformers, observe the direction of current flow or energy flow. If the current transformer is installed the wrong way, the sign of the measured value will be inverted.

A prerequisite for this is that energy is supplied to the device.

- Assigning the measuring voltage input/current transformer input:

The current transformer on terminal 20/21 (k1/l1) must be installed in the phase in which the measuring voltage for terminal 10 (L1) is measured. The same applies to the other transformer and measuring voltage connections.

- With the multimess F144-2-LED-...-5, you can check the phase sequence as follows:
 - Go to the main menu "1"
 - Connect the current transformer to the corresponding wires
 - If the connection and direction of energy flow are correct, the device will only display positive currents.
 - If the device is connected incorrectly, all currents displayed will be negative. In this case, swap the connections until the display shows the correct values.



CAUTION

Before any interchanging, the current transformers must be shorted out!

6.3 Connection diagram



NOTE

When connecting the phase (L1) to terminal 1 and the neutral conductor (N) to terminal 2 at US1 Ph-N 100V – 240V AC 50/60 Hz or US5 Ph-N 22.5V – 64V AC 50/60 Hz the safety device and the disconnector in the supply line to terminal 2 (N) are not required.

The safety device and the disconnector to terminal 2 (N) are only required for the following connection variants:

Alternating voltage:

Terminal 1 (L1) and terminal 2 (L2):

US1 Phase-Phase 100 V – 240 V AC 50/60 Hz or US5 Phase-Phase 22.5 V – 64 V AC 50/60 Hz

Direct voltage:

Terminal 1 (+) and terminal 2 (-):

US1 100V - 240V DC or US5 22.5V - 64V DC

Connection variants of the supply voltage:

Terminal 1	Terminal 2	Voltage		Safety device and disconnector to Terminal 2 required
		Power supply unit US1	Power supply unit US5	
Phase L	Neutral conductor N	100V - 240V AC 50/60 Hz	22.5V - 64V AC 50/60 Hz	No
Phase L1	Phase L2	100V - 240V AC 50/60 Hz	22.5V - 64V AC 50/60 Hz	Yes
+	-	100V - 240V DC	22.5V - 64V DC	Yes

24315_EDEBD A0264-1419-1_EN

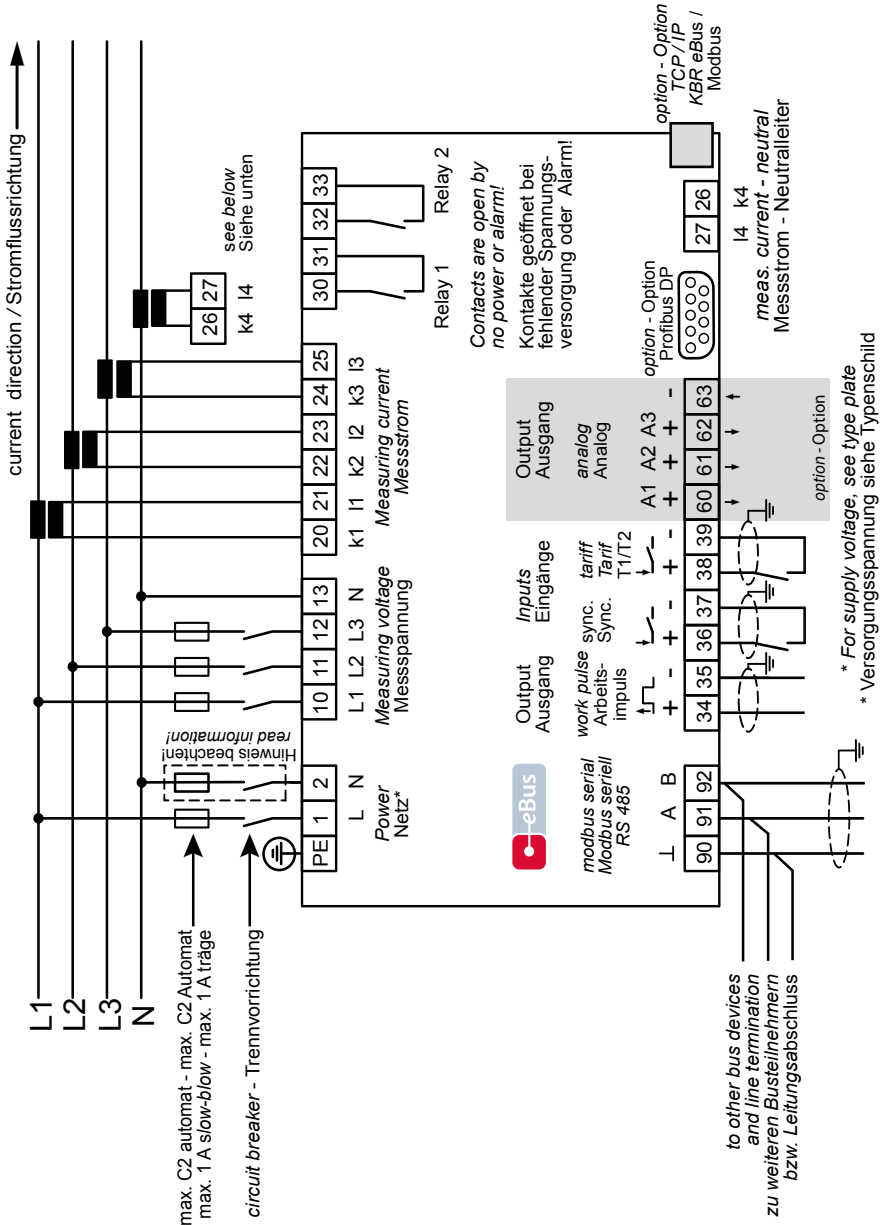

* For supply voltage, see type plate
* Versorgungsspannung siehe Typenschild

6.4 Terminal assignment

Terminal	
PE	Protective earth
1 (L) and 2 (N):	<p>Power supply connection</p> <p>A control voltage is required to supply the device with power. The device has a multi-range power supply unit and can be supplied with different different selectable voltages (see nameplate).</p>
10 (L1) 11 (L2) 12 (L3) 13 (N)	<p>Voltage measurement inputs Three-phase voltage measurement in 3-wire and 4-wire three-phase networks. Direct measurement for 3x 5 - 100 - 120 V AC or 3x 20 - 500 - 600 V AC. The measuring range is configurable. If the measuring range is exceeded, an error message is displayed. For higher voltages, the device needs to be connected via a voltage transformer.</p>
20 (k1) and 21 (l1) 22 (k2) and 23 (l2) 24 (k3) and 25 (l3)	<p>Current measurement inputs</p> <p>The current measurement inputs must be connected via current transformers x/1 A AC or x/5 A AC.</p> <p>When connecting transformers, pay attention to the direction of energy flow and the correct assignment of measuring voltage inputs to the current transformers.</p>
26 (k4) and 27 (l4)	<p>Current measurement input for the neutral conductor</p> <p>The current measurement input for the neutral conductor must be connected via current transformers x/1 A AC or x/5 A AC.</p>
30 and 31:	<p>Floating relay contact relay 1</p> <p>This contact serves as a message or alarm output. During operation, an acoustic or visual message can be activated or a consumer switched off using this relay. The contact is open as long as the device is dead as well as when there is an active message. Maximum switching capacity 2 A at 250 V AC (not safe to touch).</p>
32 and 33:	<p>Floating relay contact relay 2</p> <p>See description of floating relay contact relay 1</p>
90 (ground) 91 (A) 92 (B):	<p>Interface connection</p> <p>For KBR-eBus or Modbus communication.</p>

Terminal

34 (+) and 35 (-):

Pulse output

Output of energy-proportional pulses via a digital contact (S0 interface in accordance with DIN 43864). Ensure that the output has the right polarity. The output signals can be processed by a maximum-demand monitor or a master central process control, for example.

36 (+) and 37 (-):

Synchronization input

A floating contact, e.g. from the energy supplier, can be connected to this input to synchronize the measurement period

38 (+) and 39 (-):

Rate input

A floating contact, e.g. from the energy supplier, can be connected to this input to switch from peak to off-peak rate.

60, 61, 62 (+) and 63 (-):

Analog outputs (optional)

These three outputs can be used to output various parameters as analog values, either between 0 - 20 mA or 4 - 20 mA or between 0 - 10 V and 2 - 10 V. Depending on which parameter you wish to output, you can assign a certain phase (L1, L2, L3) or its whole value to the analog output. See the table in the menu Analog outputs (9.17) for further output values.









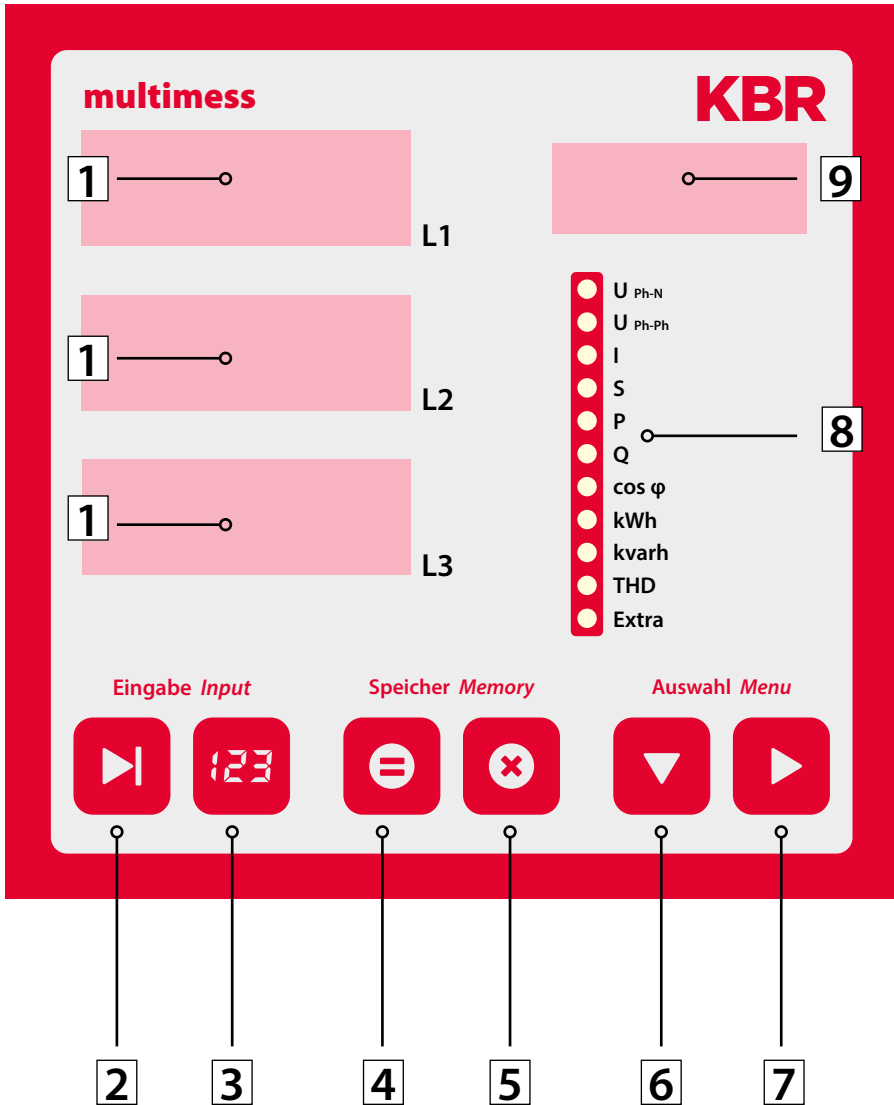

NOTE

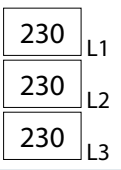
The negative pole of the synchronization input, the tariff input and the analog outputs are located internally on the PE (protective earth).

7 Control and display panel

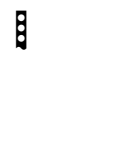
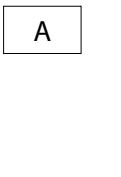

7.1 Description of sensor buttons and displays

<p>1</p>		<p>Three 4-digit 7-segment displays are used to display the measured, stored and programmed values (3-phase; L1-L2-L3).</p>
<p>2</p>		<p>Starts the programming mode and switches between the segments to be edited in 1 and 9. When you select a segment to edit it, it starts flashing.</p>
<p>3</p>		<p>In programming mode, this changes the flashing value to 1 or the decimal point to 1 and the unit prefix to 9.</p>
<p>4</p>		<p>Display for saved minimum and maximum values. In programming mode, this saves the parameters or values entered.</p>
<p>5</p>		<p>Deletes the values displayed by pressing , e.g. outliers, energy etc. In programming mode, you can use this button to cancel programming without applying any changes.</p>
<p>6</p>		<p>Selects one of the 11 main menus or jumps back from a submenu to the current main menu. Hold the button to automatically switch between the main menus. In programming mode, you can use this button to switch between the input fields L1, L2 and L3.</p>
<p>7</p>		<p>Takes you to the corresponding submenu.</p>
<p>8</p>		<p>There are 11 green LEDs, one for each main menu. A steady LED indicates the currently selected menu. If an LED is flashing, a limit in the corresponding menu has been violated, but the LED does not flash if the limit violation occurred in the menu currently being displayed.</p>
<p>9</p>		<p>The 4-digit 15-segment display shows information and the dimensions of the values in 1. When reading the saved outliers, the display switches between the unit and MIN for minimum value or MAX for maximum value. This principle also applies to the other menus and will be described in the respective sections of this manual.</p>

**NOTE**

The display on the measuring device has a dimming function (energy saving function).

After a set time has expired (15 minutes), the display brightness is reduced unless the sensor key is pressed (value is not adjustable). If any key is pressed, the original display brightness is restored.

8 Operation

8.1 Menu structure of the multimes F144-2-LED-...-5



Switches between the main menus.

When you are in a menu, the corresponding LED lights up (not flashing).

Hold the button to automatically switch between the individual main menus.

Press this button in a submenu to switch back to the corresponding main menu without applying any changes.



Switches to the desired submenu.

Press this button to switch from the last submenu back to the corresponding main menu.



Switches to a parameter assignment menu or to the display submenu
Distortion current I_d .



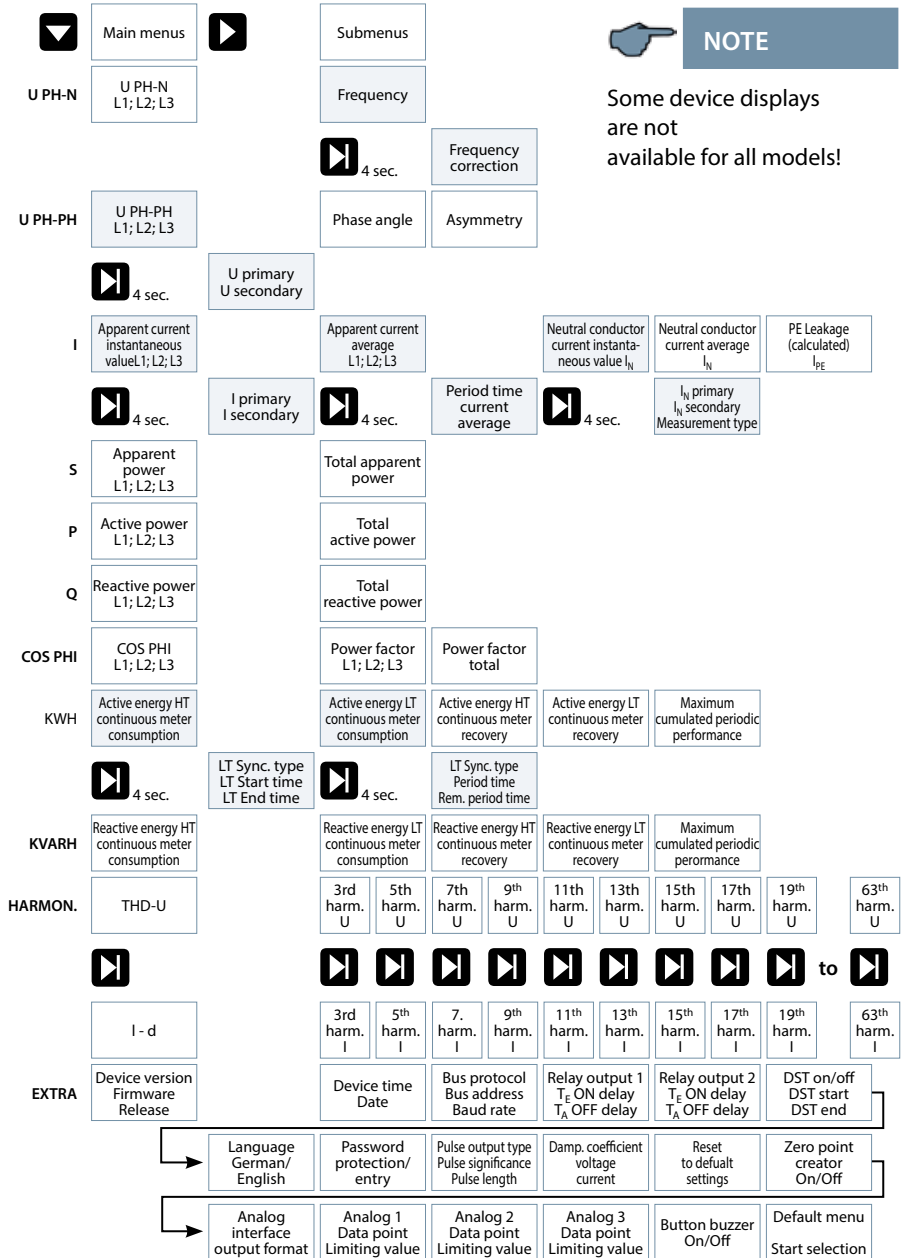



8.2 Navigation and device displays



24315_EDBD0A0264-1419-1_EN

9 Setting the operating parameters

9.1 General programming scheme

	<ul style="list-style-type: none"> ▪ Press this button for 4 seconds to switch to programming mode from a main menu or submenu. The current parameters are displayed. ▪ Press this button again to activate parameter input mode. ▪ This button is also used to switch from one screen to the next when entering values.
	<ul style="list-style-type: none"> ▪ Value input.
	<ul style="list-style-type: none"> ▪ In programming mode, switch between input fields L1, L2, L3 or go to the submenu.
	<ul style="list-style-type: none"> ▪ In programming mode, press this button to switch between input fields L1, L2 and L3. ▪ It is also used to return to the main menu after saving changes or exiting programming mode.
	<ul style="list-style-type: none"> ▪ This button is used to save changes.
	<ul style="list-style-type: none"> ▪ Press this button if you want to exit programming mode without applying any changes.

9.2 U_{Ph-Ph} - measuring reference voltage/rated mains voltage

Menu	Button(s)	Device display	Description
Main menu UPh-Ph			
Sub menu Set voltage transformer ratio	<p> Press and hold button for 4 seconds</p> <p> Start input mode</p>		<p>When you open the menu, the following text is shown on the display: VOLTAGE TRANSFORMER RATIO UPRI / USEC V/V</p> <p>The Display L1 shows the primary voltage. Display L2 shows the secondary voltage.</p>
Submenu Voltage Set primary transformer ratio	<p> Change value</p> <p>or</p> <p> Next digit</p> <p>or</p> <p> Cancel</p> <p>or</p> <p> Save</p>		<p>The first digit on the Display L1 flashes. Press the button to set the number for this segment.</p> <p>Press the button to go to the next digit.</p> <p>Once all of the digits have been set, Display L1 flashes. To move the decimal point, press the button</p>
 NOTE	or	Use these buttons to switch between the displays in input mode (one digit flashes).	
Submenu Voltage Set secondary transformer ratio	<p> Change value</p> <p>or</p> <p> Next digit</p> <p>or</p> <p> Cancel</p> <p>or</p> <p> Save</p>		<p>The first digit on Display L2 flashes. Press the button to set the number for this segment.</p> <p>Press the button to go to the next digit.</p> <p>The value can be set between 1 V and 600 V.</p>
 NOTE	<p></p> <p></p> <p> or </p>	<p>Return to main menu.</p> <p>Continue to the next submenu, if available, or return to the main menu.</p> <p>Use these buttons to switch between the displays in input mode (one digit flashes).</p>	









9.3 I - Current transformer ratio

Menu	Button(s)	Device display	Description
Main menu I			
Submenu Current Set transform- er ratio	<p> Press and hold button for 4 seconds</p> <p> Start input mode</p>		<p>When you open the menu, the following text is shown on the display: A/A CURRENT TRANSFORMER RATIO IPRI/ISEC A\A</p> <p>Display L1 shows the primary current. Display L2 shows the secondary current.</p>
Submenu Current Transformer ratio Set primary	<p> Change value or</p> <p> next digit</p> <p>or</p> <p> Cancel</p> <p>or</p> <p> Save</p>		<p>The first digit on the Display L1 flashes. Press the button to set the number for this segment.</p> <p>Press the button to go to the next digit.</p> <p>Once all of the digits have been set, Display L1 flashes. To move the decimal point, press the button</p>
 NOTE	or	Use these buttons to switch between the displays in input mode (one digit flashes).	
Submenu Current Set secondary transformer ratio	<p> Change value or</p> <p> Cancel</p> <p>or</p> <p> Save</p>		<p>The first digit on Display L2 flashes. Press to switch between 1 A and 5 A.</p>
 NOTE	<p></p> <p></p> <p> or </p>	<p>Return to main menu.</p> <p>Continue to the next submenu, if available, or return to the main menu.</p> <p>Use these buttons to switch between the displays in input mode (one digit flashes).</p>	

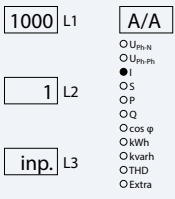
9.4 I_N- Current transformer ratio





Menu	Button(s)	Device display	Description
Main menu I			
Submenu current I _N Set transformer ratio	<p> Press and hold button for 4 seconds</p> <p> Start input mode</p>		<p>When you open this menu, the following text is shown on the display: A/A CURRENT TRANSFORMER RATIO I_N PRI/ISEK A/A</p> <p>Display L1 shows the primary current.</p> <p>Display L2 shows the secondary current.</p> <p>Display L3 shows the measurement type.</p> <p>CALC = calculated</p> <p>IN = transformer output terminal 26 (k4) and 27 (I4)</p>
Submenu current I _N Set primary transformer ratio	<p> Change value or</p> <p> next digit</p> <p>or</p> <p> Cancel</p> <p>or</p> <p> Save</p>		<p>The first digit on the Display L1 flashes. Press the button to set the number for this segment.</p> <p>Press the button to go to the next digit.</p> <p>Once all of the digits have been set, Display L1 flashes.</p> <p>To move the decimal point, press the button</p>
NOTE	or	Use these buttons to switch between the displays in input mode (one digit flashes).	
Submenu current I _N Set secondary transformer ratio	<p> Change value or</p> <p> Cancel</p> <p>or</p> <p> Save</p>		<p>The first digit on Display L2 flashes. Press to switch between 1 A and 5 A.</p>
NOTE	or	Use these buttons to switch between the displays in input mode (one digit flashes).	

24315_EDBD00264-1419-1_EN

Menu	Button(s)	Device display	Description
Submenu current I_N Set measurement type	 Change value or  Cancel or  Save		Display L3 flashes. Press the  button to set the number. Display L3 shows the measurement type. CALC = calculated IN = transformer output terminal 26 (k4) and 27 (l4)
 NOTE	   or 	Return to main menu. Continue to the next submenu, if available, or return to the main menu. Use these buttons to switch between the displays in input mode (one digit flashes).	

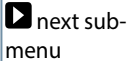
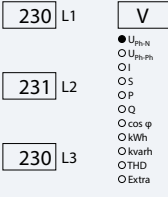
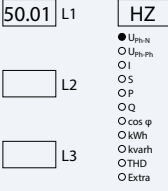
10 Display functions



10.1 U_{Ph-N} - Voltage phase to neutral conductor, frequency

Menu	Button(s)	Device display	Description
Main menu U_{Ph-N}			<p>Displays the three phase voltages U_{L1-N}, U_{L2-N} and U_{L3-N} in the Displays L1 to L3.</p> <p>The unit display shows the voltage unit.</p> <p>The measuring range automatically switches from V to KV etc.</p>
Submenu Frequency			<p>Shows the instantaneous frequency in Display L1.</p> <p>Pressing the  button for approx. 4 seconds displays the programming menu for frequency correction.</p>
 NOTE	 	<p>Return to main menu.</p> <p>Continue to the next submenu, if available, or return to the main menu.</p>	



NOTE

The default setting "AUTO" means an automatic frequency correction in the range 45 Hz to 65 Hz. It is recommended that this setting is retained.

If necessary however, "fixed 50Hz" or "fixed 60 Hz" can be set using the  and  buttons.

The setting is saved by pressing the  button.

10.2 U_{Ph-Ph} - Voltage phase to phase, rotary field display

Menu	Button(s)	Device display	Description
Main menu U _{Ph-Ph}			<p>The three phase-to-phase voltages U_{L1-L2}, U_{L2-L3} and U_{L3-L1} are shown in the Displays L1 to L3.</p> <p>The unit display shows the voltage unit.</p> <p>The device switches from V to KV etc. automatically.</p>
Submenu Rotary field			<p>Displays the three rotary field angles of the voltages.</p> <p>The unit display shows the unit "DEG."</p>
Submenu Asymmetry			<p>Display of voltage asymmetry according to the standard EN 6100-4-30:2003</p> <p>Shows the asymmetric load of the three-phase network.</p> <p>The unit display switches between ASYM and %.</p>
 NOTE	 	<p>Return to main menu.</p> <p>Continue to the next submenu, if available, or return to the main menu.</p>	

10.3 I/I_N - Current/neutral conductor current, I_{PE} (PE – leakage calculated), instantaneous- average value switching

Menu	Button(s)	Device display	Description
Main menu Instantaneous value	next sub-menu		<p>Displays the three conductor currents in phases L1, L2 and L3.</p> <p>The values displayed are instantaneous values.</p> <p>The unit display switches between ACT and A.</p>
Submenu Average value	next sub-menu		<p>Displays the three conductor currents in phases L1, L2 and L3.</p> <p>The values displayed are average values.</p> <p>The unit display switches between AVG and A.</p>









NOTE

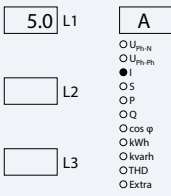

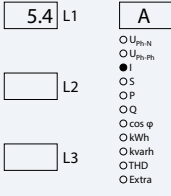
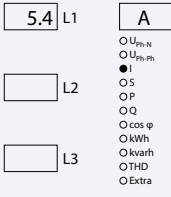



A negative sign in front of the displayed current values indicates a negative current direction.

A positive sign indicates energy consumption.

A negative sign indicates energy recovery.

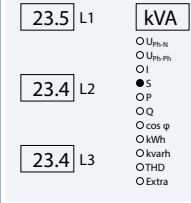
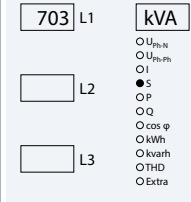
Menu	Button(s)	Device display	Description
Submenu I_N Neutral conductor current	 next submenu		<p>Display L1 shows the instantaneous neutral conductor current.</p> <p>The unit display switches between NACT and A.</p>
Submenu I_N Neutral conductor current Average value	 next submenu		<p>Display L1 shows the average value of the neutral conductor current.</p> <p>The unit display switches between NAVG and A.</p>
Submenu I_{PE} (PE leakage current)			<p>Display L1 shows the calculated PE leakage current.</p> <p>The unit display switches between I PE and A.</p>
 NOTE	 	<p>Return to main menu.</p> <p>Continue to the next submenu, if available, or return to the main menu.</p>	







10.4 S - Apparent power/total apparent power

Menu	Button(s)	Device display	Description
			
Main menu S Apparent power	 next sub-menu		<p>The Displays L1 to L3 show the apparent power of the three phases. The unit display shows the apparent power in kVA.</p> <p>The measuring range automatically switches from VA to KVA and MVA.</p>
Submenu Total apparent power			<p>Shows the total apparent power in Display L1.</p> <p>The unit display switches between kVA and SSUM (STOT). The measuring range automatically switches from VA to kVA or Mva.</p>
 NOTE	 	<p>Return to main menu.</p> <p>Continue to the next submenu, if available, or return to the main menu.</p>	

10.5 P - Active power/total active power

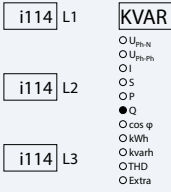
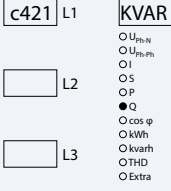
Menu	Button(s)	Device display	Description
Main menu P Active power	next sub-menu		<p>The Displays L1 to L3 show the active power of the three phases.</p> <p>The unit display shows the active power in kW.</p> <p>The device switches from W to kW or MW automatically.</p>
Submenu Total active power			<p>Shows the total active power in Display L1.</p> <p>The unit display switches between PTOT and kW.</p> <p>The device switches from W to kW or MW automatically.</p>
NOTE	 	<p>Return to main menu.</p> <p>Continue to the next submenu, if available, or return to the main menu.</p>	

10.6 Q - Reactive power/total reactive power

Menu	Button(s)	Device display	Description
			
Main menu Q Reactive power	 next sub- menu		<p>Displays L1 to L3 show the reactive power of the three phases.</p> <p>An "i" in front of a value indicates inductive, a "c" indicates capacitive reactive power.</p> <p>The unit display shows the reactive power in KVAR.</p> <p>The measuring range automatically switches from VAR to MVAR.</p>
Submenu Total reactive power			<p>Shows the total reactive power in Display L1.</p> <p>An "i" in front of a value indicates inductive, a "c" indicates capacitive reactive power.</p> <p>The unit display switches between QTOT and KVAR. The measuring range automatically switches from VAR to MVAR.</p>
 NOTE	 	<p>Return to main menu.</p> <p>Continue to the next submenu, if available, or return to the main menu.</p>	





10.7 Cos φ - Fundamental power factor, PF, total PF

Menu	Button(s)	Device display	Description
Main menu Cos φ	next sub-menu		<p>Display of cosφ.</p> <p>Display L1 shows the cosφ for phase L1. (i = inductive, c = capacitive)</p> <p>Display L2 shows the cosφ for phase L2. (i = inductive, c = capacitive)</p> <p>Display L3 shows the cosφ for phase L3. (i = inductive, c = capacitive) The unit display shows COS. (The cosφ displayed refers to the fundamental)</p>
Submenu Power factor	next sub-menu		<p>Display of the power factor PF. Display L1 shows the power factor 1 for the phase L1. Display L2 shows the power factor 2 for phase L2. Display L3 shows the power factor 3 for phase L3. The unit display shows PF.</p>
Submenu Total PF			<p>Displays the power factor total. Display L1 shows the power factor total.</p> <p>The unit display switches between TOT and PF.</p>
NOTE	 	<p>Return to main menu.</p> <p>Continue to the next submenu, if available, or return to the main menu.</p>	

10.8 kWh - Active energy HT/LT consumption and recovery, maximum cumulated cycle active power

Menu	Button(s)	Device display	Description
Main menu kWh Active energy High tariff Consumption	next sub-menu		Active energy meter for high tariff consumption. Display L3 - L1 shows the value of the continuous energy meter. The unit display switches between HT and KWh. 1234 Display L1 (G Wh display) 567 Display L2 (M Wh display) 890.1 Display L3 (k Wh display)
Submenu kWh Active energy Low tariff Con- sumption	next sub-menu		Active energy meter for low tariff consumption. Display L3 - L1 shows the value of the continuous energy meter. The unit display switches between LT and KWh. 1234 Display L1 (G Wh display) 567 Display L2 (M Wh display) 890.1 Display L3 (k Wh display)
Submenu kWh Active energy High tariff Recovery	next sub-menu		Active energy meter for high tariff recovery. Display L3 - L1 shows the value of the continuous energy meter. The unit display switches between HT and KWh. 1234 Display L1 (G Wh display) 567 Display L2 (M Wh display) 890.1 Display L3 (k Wh display)



Continued

Menu	Button(s)	Device display	Description
Submenu kWh Active energy Low tariff Recovery	 next sub-menu	<div style="display: flex; flex-direction: column; align-items: center;"> <div style="display: flex; align-items: center; margin-bottom: 10px;"> <div style="border: 1px solid black; padding: 2px 5px;">1234</div> <div style="margin: 0 5px;">L1</div> <div style="border: 1px solid black; padding: 2px 5px;">KWh</div> </div> <div style="margin-bottom: 10px;"> <ul style="list-style-type: none"> <input type="radio"/> U_{pn,N} <input type="radio"/> U_{pn,m} <input type="radio"/> I <input type="radio"/> S <input type="radio"/> P <input type="radio"/> Q <input type="radio"/> cos φ <input checked="" type="radio"/> kWh <input type="radio"/> kvarh <input type="radio"/> THD <input type="radio"/> Extra </div> <div style="display: flex; align-items: center; margin-bottom: 10px;"> <div style="border: 1px solid black; padding: 2px 5px;">567</div> <div style="margin: 0 5px;">L2</div> </div> <div style="margin-bottom: 10px;"> <ul style="list-style-type: none"> <input type="radio"/> U_{pn,N} <input type="radio"/> U_{pn,m} <input type="radio"/> I <input type="radio"/> S <input type="radio"/> P <input type="radio"/> Q <input type="radio"/> cos φ <input checked="" type="radio"/> kWh <input type="radio"/> kvarh <input type="radio"/> THD <input type="radio"/> Extra </div> <div style="display: flex; align-items: center;"> <div style="border: 1px solid black; padding: 2px 5px;">890.1</div> <div style="margin: 0 5px;">L3</div> </div> </div>	<p>Active energy meter for low tariff recovery.</p> <p>Display L3 - L1 shows the value of the continuous energy meter.</p> <p>The unit display switches between LT and KWh.</p> <p>1234 Display L1 (G Wh display) 567 Display L2 (M Wh display) 890.1 Display L3 (k Wh display)</p>
Submenu PCum-Max Maximum cumulated cycle power		<div style="display: flex; flex-direction: column; align-items: center;"> <div style="display: flex; align-items: center; margin-bottom: 10px;"> <div style="border: 1px solid black; padding: 2px 5px;">783</div> <div style="margin: 0 5px;">L1</div> <div style="border: 1px solid black; padding: 2px 5px;">KW</div> </div> <div style="margin-bottom: 10px;"> <ul style="list-style-type: none"> <input type="radio"/> U_{pn,N} <input type="radio"/> U_{pn,m} <input type="radio"/> I <input type="radio"/> S <input type="radio"/> P <input type="radio"/> Q <input type="radio"/> cos φ <input checked="" type="radio"/> kWh <input type="radio"/> kvarh <input type="radio"/> THD <input type="radio"/> Extra </div> <div style="display: flex; align-items: center; margin-bottom: 10px;"> <div style="border: 1px solid black; padding: 2px 5px;">12:10</div> <div style="margin: 0 5px;">L2</div> </div> <div style="margin-bottom: 10px;"> <ul style="list-style-type: none"> <input type="radio"/> U_{pn,N} <input type="radio"/> U_{pn,m} <input type="radio"/> I <input type="radio"/> S <input type="radio"/> P <input type="radio"/> Q <input type="radio"/> cos φ <input checked="" type="radio"/> kWh <input type="radio"/> kvarh <input type="radio"/> THD <input type="radio"/> Extra </div> <div style="display: flex; align-items: center;"> <div style="border: 1px solid black; padding: 2px 5px;">1:10</div> <div style="margin: 0 5px;">L3</div> </div> </div>	<p>When you open the menu, the following text is shown in the unit display:</p> <p>PC.MX MAXIMUM CUMULATED POWER IN PERIOD</p> <p>Then the display switches between PC.MX and KW.</p> <p>Display L1 shows the period value.</p> <p>Display L2 shows the exact time the maximum occurred (hh:mm).</p> <p>Display L3 shows the day and month, alternating with the year, of the maximum (dd.mm.yyyy).</p>
 NOTE	 	Return to main menu.	Continue to the next submenu, if available, or return to the main menu.

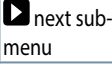
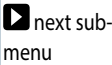
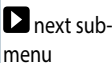
10.9 kvarh - Reactive energy meter HT/LT consumption and recovery, maximum cumulated cycle reactive power

Menu	Button(s)	Device display	Description
			
Main menu kvarh Reactive energy High tariff Consumption		<div style="display: flex; flex-direction: column; align-items: flex-start;"> <div style="display: flex; align-items: center; margin-bottom: 10px;"> <div style="border: 1px solid black; padding: 2px 5px; margin-right: 5px;">1234</div> <div style="margin-right: 5px;">L1</div> <div style="margin-left: 20px; border: 1px solid black; padding: 2px 5px;">kBh</div> </div> <div style="font-size: 8px; margin-bottom: 10px;"> <ul style="list-style-type: none"> <input type="radio"/> U_{Ph-N} <input type="radio"/> U_{Ph-Pk} <input type="radio"/> OI <input type="radio"/> OS <input type="radio"/> OP <input type="radio"/> OQ <input type="radio"/> Ocos φ <input type="radio"/> kWh <input checked="" type="radio"/> kvarh <input type="radio"/> THD <input type="radio"/> Extra </div> <div style="display: flex; align-items: center; margin-bottom: 10px;"> <div style="border: 1px solid black; padding: 2px 5px; margin-right: 5px;">567</div> <div style="margin-right: 5px;">L2</div> </div> <div style="display: flex; align-items: center;"> <div style="border: 1px solid black; padding: 2px 5px; margin-right: 5px;">890.1</div> <div style="margin-right: 5px;">L3</div> </div> </div>	<p>Reactive energy meter for high tariff consumption.</p> <p>Display L3 - L1 shows the value of the reactive energy continuous meter. The unit display switches between HT and kBh.</p> <p>1234 Display L1 (G varh display) 567 Display L2 (M varh display) 890.1 Display L3 (k varh display)</p>
Submenu kvarh Reactive energy Low tariff Consumption		<div style="display: flex; flex-direction: column; align-items: flex-start;"> <div style="display: flex; align-items: center; margin-bottom: 10px;"> <div style="border: 1px solid black; padding: 2px 5px; margin-right: 5px;">1234</div> <div style="margin-right: 5px;">L1</div> <div style="margin-left: 20px; border: 1px solid black; padding: 2px 5px;">kBh</div> </div> <div style="font-size: 8px; margin-bottom: 10px;"> <ul style="list-style-type: none"> <input type="radio"/> U_{Ph-N} <input type="radio"/> U_{Ph-Pk} <input type="radio"/> OI <input type="radio"/> OS <input type="radio"/> OP <input type="radio"/> OQ <input type="radio"/> Ocos φ <input type="radio"/> kWh <input checked="" type="radio"/> kvarh <input type="radio"/> THD <input type="radio"/> Extra </div> <div style="display: flex; align-items: center; margin-bottom: 10px;"> <div style="border: 1px solid black; padding: 2px 5px; margin-right: 5px;">567</div> <div style="margin-right: 5px;">L2</div> </div> <div style="display: flex; align-items: center;"> <div style="border: 1px solid black; padding: 2px 5px; margin-right: 5px;">890.1</div> <div style="margin-right: 5px;">L3</div> </div> </div>	<p>Reactive energy meter for low tariff consumption.</p> <p>Display L3 - L1 shows the value of the reactive energy continuous meter. The unit display switches between LT and kBh.</p> <p>1234 Display L1 (G varh display) 567 Display L2 (M varh display) 890.1 Display L3 (k varh display)</p>
Submenu kvarh Reactive energy High tariff Recovery		<div style="display: flex; flex-direction: column; align-items: flex-start;"> <div style="display: flex; align-items: center; margin-bottom: 10px;"> <div style="border: 1px solid black; padding: 2px 5px; margin-right: 5px;">1234</div> <div style="margin-right: 5px;">L1</div> <div style="margin-left: 20px; border: 1px solid black; padding: 2px 5px;">kBh</div> </div> <div style="font-size: 8px; margin-bottom: 10px;"> <ul style="list-style-type: none"> <input type="radio"/> U_{Ph-N} <input type="radio"/> U_{Ph-Pk} <input type="radio"/> OI <input type="radio"/> OS <input type="radio"/> OP <input type="radio"/> OQ <input type="radio"/> Ocos φ <input type="radio"/> kWh <input checked="" type="radio"/> kvarh <input type="radio"/> THD <input type="radio"/> Extra </div> <div style="display: flex; align-items: center; margin-bottom: 10px;"> <div style="border: 1px solid black; padding: 2px 5px; margin-right: 5px;">567</div> <div style="margin-right: 5px;">L2</div> </div> <div style="display: flex; align-items: center;"> <div style="border: 1px solid black; padding: 2px 5px; margin-right: 5px;">890.1</div> <div style="margin-right: 5px;">L3</div> </div> </div>	<p>Reactive energy meter for high tariff recovery.</p> <p>Display L3 - L1 shows the value of the reactive energy continuous meter. The unit display switches between HT and kBh.</p> <p>1234 Display L1 (G varh display) 567 Display L2 (M varh display) 890.1 Display L3 (k varh display)</p>

Continuation of table 10.9







Menu	Button(s)	Device display	Description
Submenu kvarh Reactive energy Low tariff Recovery	 next sub- menu	<div style="display: flex; flex-direction: column; align-items: flex-start;"> <div style="display: flex; align-items: center; margin-bottom: 10px;"> <div style="border: 1px solid black; padding: 2px 5px; margin-right: 5px;">1234</div> <div style="margin-right: 5px;">L1</div> <div style="margin-left: 20px; border: 1px solid black; padding: 2px 5px;">kBh</div> </div> <div style="margin-bottom: 10px;"> <ul style="list-style-type: none"> <input type="radio"/> U_{rms,N} <input type="radio"/> U_{rms,Ph} <input type="radio"/> OI <input type="radio"/> OS <input type="radio"/> OP <input type="radio"/> OQ <input type="radio"/> O cos φ <input type="radio"/> kWh <input checked="" type="radio"/> kvarh <input type="radio"/> THD <input type="radio"/> Extra </div> <div style="display: flex; align-items: center; margin-bottom: 10px;"> <div style="border: 1px solid black; padding: 2px 5px; margin-right: 5px;">567</div> <div style="margin-right: 5px;">L2</div> </div> <div style="margin-bottom: 10px;"> <ul style="list-style-type: none"> <input type="radio"/> U_{rms,N} <input type="radio"/> U_{rms,Ph} <input type="radio"/> OI <input type="radio"/> OS <input type="radio"/> OP <input type="radio"/> OQ <input type="radio"/> O cos φ <input type="radio"/> kWh <input checked="" type="radio"/> kvarh <input type="radio"/> THD <input type="radio"/> Extra </div> <div style="display: flex; align-items: center;"> <div style="border: 1px solid black; padding: 2px 5px; margin-right: 5px;">890.1</div> <div style="margin-right: 5px;">L3</div> </div> </div>	<p>Reactive energy meter for low tariff recovery.</p> <p>Display L3 - L1 shows the value of the reactive energy continuous meter. The unit display switches between LT and kBh.</p> <p>1234 Display L1 (G varh display) 567 Display L2 (M varh display) 890.1 Display L3 (k varh display)</p>
Submenu Q _{Kum-Max} Maximum cumulated cycle power		<div style="display: flex; flex-direction: column; align-items: flex-start;"> <div style="display: flex; align-items: center; margin-bottom: 10px;"> <div style="border: 1px solid black; padding: 2px 5px; margin-right: 5px;">783</div> <div style="margin-right: 5px;">L1</div> <div style="margin-left: 20px; border: 1px solid black; padding: 2px 5px;">kBh</div> </div> <div style="margin-bottom: 10px;"> <ul style="list-style-type: none"> <input type="radio"/> U_{rms,N} <input type="radio"/> U_{rms,Ph} <input type="radio"/> OI <input type="radio"/> OS <input type="radio"/> OP <input type="radio"/> OQ <input type="radio"/> O cos φ <input type="radio"/> kWh <input checked="" type="radio"/> kvarh <input type="radio"/> THD <input type="radio"/> Extra </div> <div style="display: flex; align-items: center; margin-bottom: 10px;"> <div style="border: 1px solid black; padding: 2px 5px; margin-right: 5px;">12:10</div> <div style="margin-right: 5px;">L2</div> </div> <div style="margin-bottom: 10px;"> <ul style="list-style-type: none"> <input type="radio"/> U_{rms,N} <input type="radio"/> U_{rms,Ph} <input type="radio"/> OI <input type="radio"/> OS <input type="radio"/> OP <input type="radio"/> OQ <input type="radio"/> O cos φ <input type="radio"/> kWh <input checked="" type="radio"/> kvarh <input type="radio"/> THD <input type="radio"/> Extra </div> <div style="display: flex; align-items: center;"> <div style="border: 1px solid black; padding: 2px 5px; margin-right: 5px;">1:10</div> <div style="margin-right: 5px;">L3</div> </div> </div>	<p>When you open the menu, the following text is shown in the unit display:</p> <p>QC.MX MAXIMUM CUMULATED POWER IN PERIOD</p> <p>Then the display switches between PC.MX and KVAR.</p> <p>Display L1 shows the period value. Display L2 shows the exact time the maximum occurred (hh:mm). Display L3 shows the day and month, alternating with the year, of the maximum (dd.mm.yyyy).</p>
 NOTE	<ul style="list-style-type: none"> <input checked="" type="checkbox"/> <input checked="" type="checkbox"/> 	<p>Return to main menu.</p> <p>Continue to the next submenu, if available, or return to the main menu.</p>	



NOTE

The daily energy meters (for active and reactive energy) of the device can only be read out via the KBR eBus with the optionally available software.





10.10 THD- distortion factor and partial harmonic content of the voltage and current network harmonics

Menu	Button(s)	Device display	Description
			
Main menu THD voltage distortion factor	 next sub-menu or  Switching between voltage and current harmonics	<div style="display: flex; flex-direction: column; align-items: flex-start;"> <div style="margin-bottom: 10px;">4.7 L1</div> <div style="margin-bottom: 10px;">4.7 L2</div> <div>4.7 L3</div> </div> <div style="margin-left: 20px; font-size: 0.8em;"> DF <input type="radio"/> U_{Ph-N} <input type="radio"/> U_{Ph-Ph} <input type="radio"/> I <input type="radio"/> S <input type="radio"/> P <input type="radio"/> Q <input type="radio"/> cos φ <input type="radio"/> kWh <input type="radio"/> kvarh <input checked="" type="radio"/> THD <input type="radio"/> Extra </div>	<p>Display L1 shows the distortion factor in % for the voltage of phase L1.</p> <p>Display L2 shows the distortion factor in % for the voltage of phase L2.</p> <p>Display L3 shows the distortion factor in % for the voltage of phase L3.</p> <p>The unit display switches between DF and %.</p>
Submenu 3-63. harmonic	 next harmonic or  Switching between voltage and current harmonics	<div style="display: flex; flex-direction: column; align-items: flex-start;"> <div style="margin-bottom: 10px;">4.7 L1</div> <div style="margin-bottom: 10px;">4.6 L2</div> <div>4.7 L3</div> </div> <div style="margin-left: 20px; font-size: 0.8em;"> 3th U <input type="radio"/> U_{Ph-N} <input type="radio"/> U_{Ph-Ph} <input type="radio"/> I <input type="radio"/> S <input type="radio"/> P <input type="radio"/> Q <input type="radio"/> cos φ <input type="radio"/> kWh <input type="radio"/> kvarh <input checked="" type="radio"/> THD <input type="radio"/> Extra </div>	<p>Displays the 3rd harmonic.</p> <p>Display L1 shows the 3rd harmonic in % for the voltage of phase L1.</p> <p>Display L2 shows the 3rd harmonic in % for the voltage of phase L2.</p> <p>Display L3 shows the 3rd harmonic in % for the voltage of phase L3.</p> <p>The unit display switches between 3rd U and %.</p> <p>The subsequent harmonics (5th – 63th) are displayed in the same way.</p> <p>For example, when displaying the current harmonic, the display switches between 3rd I and A; when displaying the distortion current strength, it switches between Id and A.</p>
 NOTE	<input checked="" type="checkbox"/> <input checked="" type="checkbox"/>	<p>Return to main menu.</p> <p>Continue to the next submenu, if available, or return to the main menu.</p>	



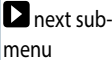
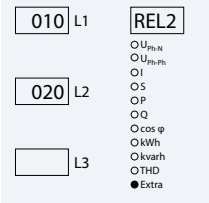
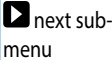
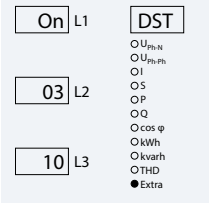
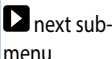
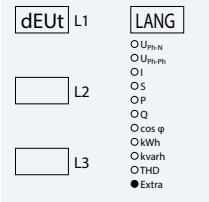
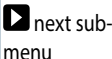
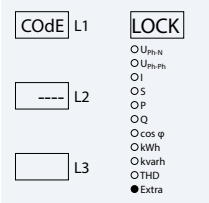



10.11 Extra

Menu	Button(s)	Device display	Description
Main menu Extra			<p>Display L1 shows the device type (here: Comfort).</p> <p>Display L2 shows the version number. Display L3 shows the release number. The unit display shows the name of the device.</p>
Submenu Date and time			<p>Display L1 shows the time (hh.mm).</p> <p>Display L2 shows the date (dd.mm).</p> <p>Display L3 shows the year (yyyy).</p> <p>The unit display shows the week-day.</p>
eBus submenu			<p>Display L1 shows the device address.</p> <p>The baud rate is shown on Display L2</p> <p>The unit display shows eBus.</p>
Submenu REL 1			<p>Display L1 shows the on-delay for relay 1 in seconds. Display L2 shows the off-delay for relay 1 in seconds.</p> <p>The unit display switches between REL1 and tON.</p>
 NOTE	 	<p>Return to main menu.</p> <p>Continue to the next submenu, if available, or return to the main menu.</p>	



Continuation of table 10.11

Menu	Button(s)	Device display	Description
Submenu REL 2		 <p>010 L1 REL2 020 L2 L3</p> <p> O U_{Ph-N} O U_{Ph-Fs} OI OS OP OQ O cos φ O kWh O kvarh OTHd ● Extra</p>	<p>Display L1 shows the on-delay for relay 2 in seconds.</p> <p>Display L2 shows the off-delay for relay 2 in seconds.</p> <p>The unit display switches between REL2 and tON.</p>
Submenu Daylight saving time		 <p>On L1 DST 03 L2 10 L3</p> <p> O U_{Ph-N} O U_{Ph-Fs} OI OS OP OQ O cos φ O kWh O kvarh OTHd ● Extra</p>	<p>Display L1 indicates whether daylight saving time is activated or not.</p> <p>Display L2: shows the month daylight saving time begins.</p> <p>Display L3: shows the month daylight saving time ends.</p> <p>The unit display shows DAYLIGHTSAVING PARAMETER and then DST.</p>
Submenu Language		 <p>dEut L1 LANG L2 L3</p> <p> O U_{Ph-N} O U_{Ph-Fs} OI OS OP OQ O cos φ O kWh O kvarh OTHd ● Extra</p>	<p>Display L1 shows the user language. For German, it displays deut.. For English, it displays engl..</p> <p>The unit display shows SPRA if the user language is German and LANG if it is English.</p>
Submenu Password		 <p>COdE L1 LOCK ---- L2 L3</p> <p> O U_{Ph-N} O U_{Ph-Fs} OI OS OP OQ O cos φ O kWh O kvarh OTHd ● Extra</p>	<p>Display L1 shows CODE.</p> <p>The unit display shows LOCK or FREE.</p> <p>You can enter the password in L2. (4-digit code)</p> <p>The device is defaulted with the code 9999, i.e. all functions of the device are available.</p>
 NOTE	 	<p>Return to main menu.</p> <p>Continue to the next submenu, if available, or return to the main menu.</p>	



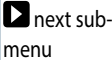
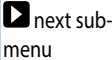
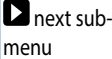
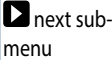

Continuation of table 10.11

Menu	Button(s)	Device display	Description
Submenu Pulse output	 next sub-menu	<div style="display: flex; flex-direction: column; align-items: flex-start;"> <div style="margin-bottom: 10px;"><input type="text" value="P"/> L1</div> <div style="margin-bottom: 10px;"><input type="text" value="1,000"/> L2</div> <div><input type="text" value="100"/> L3</div> </div> <div style="margin-left: 20px;"> <div style="border: 1px solid black; padding: 2px; margin-bottom: 5px;">PULSE</div> <ul style="list-style-type: none"> <input type="radio"/> U_{rms,N} <input type="radio"/> U_{rms,m} <input type="radio"/> I <input type="radio"/> S <input type="radio"/> P <input type="radio"/> Q <input type="radio"/> cos φ <input type="radio"/> kWh <input type="radio"/> kvarh <input type="radio"/> THD <input checked="" type="radio"/> Extra </div>	<p>Display L1 indicates whether the pulse output is deactivated (OFF) or configured for active (P) or reactive (Q) energy.</p> <p>Display L2 shows the pulse significance, i.e. pulse/kWh or kvarh.</p> <p>Display L3 displays the energy pulse length in ms.</p>
Submenu Damp. coeffi- cient	 next sub-menu	<div style="display: flex; flex-direction: column; align-items: flex-start;"> <div style="margin-bottom: 10px;"><input type="text" value="U 0"/> L1</div> <div style="margin-bottom: 10px;"><input type="text" value="1 0"/> L2</div> <div><input type="text" value=""/> L3</div> </div> <div style="margin-left: 20px;"> <div style="border: 1px solid black; padding: 2px; margin-bottom: 5px;">DF</div> <ul style="list-style-type: none"> <input type="radio"/> U_{rms,N} <input type="radio"/> U_{rms,m} <input type="radio"/> I <input type="radio"/> S <input type="radio"/> P <input type="radio"/> Q <input type="radio"/> cos φ <input type="radio"/> kWh <input type="radio"/> kvarh <input type="radio"/> THD <input checked="" type="radio"/> Extra </div>	<p>Display L1 shows the damping coefficient for acquiring the voltage.</p> <p>Display L2 shows the damping coefficient for acquiring the current.</p>
Submenu Re- set to default settings	 next sub-menu	<div style="display: flex; flex-direction: column; align-items: flex-start;"> <div style="margin-bottom: 10px;"><input type="text" value=""/> L1</div> <div style="margin-bottom: 10px;"><input type="text" value=""/> L2</div> <div><input type="text" value=""/> L3</div> </div> <div style="margin-left: 20px;"> <div style="border: 1px solid black; padding: 2px; margin-bottom: 5px;">DEF.</div> <ul style="list-style-type: none"> <input type="radio"/> U_{rms,N} <input type="radio"/> U_{rms,m} <input type="radio"/> I <input type="radio"/> S <input type="radio"/> P <input type="radio"/> Q <input type="radio"/> cos φ <input type="radio"/> kWh <input type="radio"/> kvarh <input type="radio"/> THD <input checked="" type="radio"/> Extra </div>	<p>The device is reset to the default KBR factory settings. All stored values are lost.</p> <p>The unit display shows DEFAULT PARAMETER and then DEF.</p>
Submenu Zero point creator	 next sub-menu	<div style="display: flex; flex-direction: column; align-items: flex-start;"> <div style="margin-bottom: 10px;"><input type="text" value="OFF"/> L1</div> <div style="margin-bottom: 10px;"><input type="text" value=""/> L2</div> <div><input type="text" value=""/> L3</div> </div> <div style="margin-left: 20px;"> <div style="border: 1px solid black; padding: 2px; margin-bottom: 5px;">0-P</div> <ul style="list-style-type: none"> <input type="radio"/> U_{rms,N} <input type="radio"/> U_{rms,m} <input type="radio"/> I <input type="radio"/> S <input type="radio"/> P <input type="radio"/> Q <input type="radio"/> cos φ <input type="radio"/> kWh <input type="radio"/> kvarh <input type="radio"/> THD <input checked="" type="radio"/> Extra </div>	<p>Display L1 shows OFF if it is deactivated. If the zero point creator is activated, ON is displayed.</p> <p>The unit display shows ZERO-POINT CREATOR and then 0-P.</p>
 NOTE	<ul style="list-style-type: none">   	<p>Return to main menu.</p> <p>Continue to the next submenu, if available, or return to the main menu.</p>	

Continuation of table 10.11

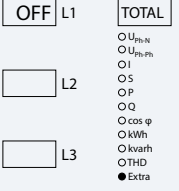
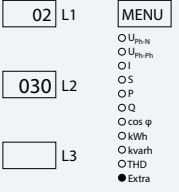







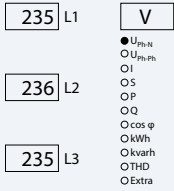

Menu	Button(s)	Device display	Description
Submenu Analog inter- faces (Option)		<div style="display: flex; flex-direction: column; align-items: flex-start;"> <div style="display: flex; align-items: center; margin-bottom: 10px;"> <div style="border: 1px solid black; padding: 2px 5px; margin-right: 5px;">4-20</div> <div style="margin-right: 5px;">L1</div> <div style="border: 1px solid black; padding: 2px 5px; margin-left: 20px;">mA</div> </div> <div style="margin-bottom: 10px;"> <div style="display: flex; align-items: center;"> <div style="border: 1px solid black; width: 30px; height: 20px; margin-right: 5px;"></div> <div style="margin-right: 5px;">L2</div> </div> </div> <div> <div style="display: flex; align-items: center;"> <div style="border: 1px solid black; width: 30px; height: 20px; margin-right: 5px;"></div> <div style="margin-right: 5px;">L3</div> </div> </div> </div> <div style="margin-left: 100px; font-size: 8px; margin-top: 5px;"> <ul style="list-style-type: none"> <input type="radio"/> U_{Ph,N} <input type="radio"/> U_{Ph,rs} <input type="radio"/> OI <input type="radio"/> OS <input type="radio"/> OP <input type="radio"/> OQ <input type="radio"/> Cos φ <input type="radio"/> kWh <input type="radio"/> kvarh <input type="radio"/> THD <input checked="" type="radio"/> Extra </div>	<p>Display L1 and the unit display show the output type. You can choose from:</p> <p>0-20 mA, 4-20 mA, 0-10 V and 2-10 V, valid for all 3 outputs.</p> <p>The unit display shows ANALOG TYPE and then mA or V.</p>
Submenu Analog 1 Data point Limiting value (Option)		<div style="display: flex; flex-direction: column; align-items: flex-start;"> <div style="display: flex; align-items: center; margin-bottom: 10px;"> <div style="border: 1px solid black; padding: 2px 5px; margin-right: 5px;">AnA1</div> <div style="margin-right: 5px;">L1</div> <div style="border: 1px solid black; padding: 2px 5px; margin-left: 20px;">U L1</div> </div> <div style="margin-bottom: 10px;"> <div style="display: flex; align-items: center;"> <div style="border: 1px solid black; padding: 2px 5px; margin-right: 5px;">220</div> <div style="margin-right: 5px;">L2</div> </div> </div> <div> <div style="display: flex; align-items: center;"> <div style="border: 1px solid black; padding: 2px 5px; margin-right: 5px;">240</div> <div style="margin-right: 5px;">L3</div> </div> </div> </div> <div style="margin-left: 100px; font-size: 8px; margin-top: 5px;"> <ul style="list-style-type: none"> <input type="radio"/> U_{Ph,N} <input type="radio"/> U_{Ph,rs} <input type="radio"/> OI <input type="radio"/> OS <input type="radio"/> OP <input type="radio"/> OQ <input type="radio"/> Cos φ <input type="radio"/> kWh <input type="radio"/> kvarh <input type="radio"/> THD <input checked="" type="radio"/> Extra </div>	<p>Display L1 shows the instantaneous analog interface.</p> <p>Display L2 shows the lower limit, Display L3 the upper limit.</p> <p>The unit display shows the parameter to be output.</p>
Submenu Analog 2 Data point Limiting value (Option)		<div style="display: flex; flex-direction: column; align-items: flex-start;"> <div style="display: flex; align-items: center; margin-bottom: 10px;"> <div style="border: 1px solid black; padding: 2px 5px; margin-right: 5px;">AnA2</div> <div style="margin-right: 5px;">L1</div> <div style="border: 1px solid black; padding: 2px 5px; margin-left: 20px;">I L1</div> </div> <div style="margin-bottom: 10px;"> <div style="display: flex; align-items: center;"> <div style="border: 1px solid black; padding: 2px 5px; margin-right: 5px;">-400</div> <div style="margin-right: 5px;">L2</div> </div> </div> <div> <div style="display: flex; align-items: center;"> <div style="border: 1px solid black; padding: 2px 5px; margin-right: 5px;">400</div> <div style="margin-right: 5px;">L3</div> </div> </div> </div> <div style="margin-left: 100px; font-size: 8px; margin-top: 5px;"> <ul style="list-style-type: none"> <input type="radio"/> U_{Ph,N} <input type="radio"/> U_{Ph,rs} <input type="radio"/> OI <input type="radio"/> OS <input type="radio"/> OP <input type="radio"/> OQ <input type="radio"/> Cos φ <input type="radio"/> kWh <input type="radio"/> kvarh <input type="radio"/> THD <input checked="" type="radio"/> Extra </div>	<p>Display L1 shows the instantaneous analog interface.</p> <p>Display L2 shows the lower limit, Display L3 the upper limit.</p> <p>For current and active power, both positive and negative values (sign in front) can be programmed. The unit display shows the parameter to be output.</p>
Submenu Analog 3 Data point Limiting value (Option)		<div style="display: flex; flex-direction: column; align-items: flex-start;"> <div style="display: flex; align-items: center; margin-bottom: 10px;"> <div style="border: 1px solid black; padding: 2px 5px; margin-right: 5px;">AnA3</div> <div style="margin-right: 5px;">L1</div> <div style="border: 1px solid black; padding: 2px 5px; margin-left: 20px;">OFF</div> </div> <div style="margin-bottom: 10px;"> <div style="display: flex; align-items: center;"> <div style="border: 1px solid black; width: 30px; height: 20px; margin-right: 5px;"></div> <div style="margin-right: 5px;">L2</div> </div> </div> <div> <div style="display: flex; align-items: center;"> <div style="border: 1px solid black; width: 30px; height: 20px; margin-right: 5px;"></div> <div style="margin-right: 5px;">L3</div> </div> </div> </div> <div style="margin-left: 100px; font-size: 8px; margin-top: 5px;"> <ul style="list-style-type: none"> <input type="radio"/> U_{Ph,N} <input type="radio"/> U_{Ph,rs} <input type="radio"/> OI <input type="radio"/> OS <input type="radio"/> OP <input type="radio"/> OQ <input type="radio"/> Cos φ <input type="radio"/> kWh <input type="radio"/> kvarh <input type="radio"/> THD <input checked="" type="radio"/> Extra </div>	<p>Display L1 shows the instantaneous analog interface.</p> <p>Display L2 shows the lower limit, Display L3 the upper limit.</p> <p>The unit display shows the parameter to be output.</p>
 NOTE	<input checked="" type="checkbox"/> <input checked="" type="checkbox"/>	<p>Return to main menu.</p> <p>Continue to the next submenu, if available, or return to the main menu.</p>	

Continuation of table 10.11

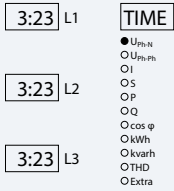
Menu	Button(s)	Device display	Description
Submenu button buzzer	 next submenu		<p>Display L1 shows the state of the button buzzer. You can choose from "ON or "OFF".</p> <p>The unit display shows SUMMER and then SUMM.</p> <p>The default setting is "ON".</p>
Submenu Default menu Start selection			<p>Display L1 shows the selected default menu (02 = U_{PH-PPH}).</p> <p>Display L2 shows the return time in seconds to the default menu.</p> <p>The unit display shows DEFAULT MENU then MENU.</p>
 NOTE	 	<p>Return to main menu.</p> <p>Continue to the next submenu, if available, or return to the main menu.</p>	

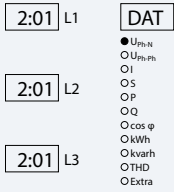
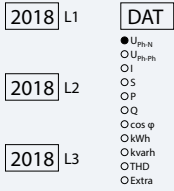
10.12 Maximum/Minimum extreme values display

The following section explains how to display the extreme values. The maximum and minimum values of the phase voltages will be used as an example.

Menu	Button(s)	Device display	Description
Main menu U_{Ph-N} Voltage Maximum	 Maximum  Display the time	 235 L1 V 236 L2 235 L3 ● U_{Ph-N} ○ U_{Ph-Ph} ○ I ○ S ○ P ○ Q ○ Cos φ ○ kWh ○ kvarh ○ THD ○ Extra	The maximum values that occurred for the phase voltages are shown in the Displays L1 to L3 for each phase. The unit display switches between MAX and V.
Voltage Maximum	 Display date (dd.mm)	 3:23 L1 TIME 3:23 L2 3:23 L3 ● U_{Ph-N} ○ U_{Ph-Ph} ○ I ○ S ○ P ○ Q ○ Cos φ ○ kWh ○ kvarh ○ THD ○ Extra	The time the maximum values occurred for the phase to neutral voltages are displayed in the Displays L1 to L3. The unit display switches between MAX and TIME.
Voltage Maximum	 Display date (yyyy)	 2:01 L1 DAT 2:01 L2 2:01 L3 ● U_{Ph-N} ○ U_{Ph-Ph} ○ I ○ S ○ P ○ Q ○ Cos φ ○ kWh ○ kvarh ○ THD ○ Extra	The day the maximum values occurred for the phase to neutral voltages are shown in the Displays L1 to L3. The unit display switches between MAX and DAT.
Voltage Maximum		 2018 L1 DAT 2018 L2 2018 L3 ● U_{Ph-N} ○ U_{Ph-Ph} ○ I ○ S ○ P ○ Q ○ Cos φ ○ kWh ○ kvarh ○ THD ○ Extra	The year the maximum values occurred for the phase to neutral voltages are displayed in the Displays L1 to L3. The unit display switches between MAX and DAT.
 NOTE	 	Return to main menu. Continue to the next submenu, if available, or return to the main menu.	



NOTE

Use the  button to switch from maximum to minimum values.
The minimum values are read the same way as the maximum values.

The following table gives an overview of all extreme values stored in the multimes F144-2-LED-...-5.

Stored extreme values with date and time they occurred.

Menu	Measured value	Stored extreme values	Text displayed in de and en
Main menu U_{Ph-N}	Phase voltage	Minimum and maximum value of L1 – L2 – L3 with date and time	Min and Max
Submenu F_{power}	Network frequency	Minimum and maximum value of L1 with date and time	Min and Max
Main menu U_{Ph-Ph}	Outer conductor voltage	Minimum and maximum value of L1 – L2 – L3 with date and time	Min and Max
Main menu I_{act}	Phase current instantaneous values	Minimum and maximum value of L1 – L2 – L3 with date and time	Min and Max
Submenu I_{avg}	Average values for phase current	Minimum and maximum value of L1 – L2 – L3 with date and time	Min and Max
Submenu I_{nact}	Instantaneous value of neutral conductor current	Minimum and maximum value of the neutral conductor current with date and time	Min and Max
Submenu I_{Navg}	Average neutral conductor current	Minimum and maximum value of the neutral conductor current with date and time	Min and Max
Submenu I_{PE}	PE Leakage calculated	Minimum and maximum value of the PE leakage with date and time	Min and Max
Main menu S	Apparent power	Minimum and maximum value of L1 – L2 – L3 with date and time	Min and Max
Submenu S_{TOT}	Total apparent power	Minimum and maximum value of the total apparent power with date and time	Min and Max
Main menu P	Active power	Minimum and maximum value of L1 – L2 – L3 with date and time	Min and Max
Submenu P_{TOT}	Total active power	Minimum and maximum value for total apparent power with date and time	Min and Max
Main menu Q	Reactive power	Minimum and maximum value of L1 – L2 – L3 with date and time	Min and Max
Submenu Q_{TOT}	Total reactive power	Minimum and maximum value for total reactive power with date and time	Min and Max

Continued

Menu	Measured value	Stored extreme values	Text displayed in de and en
Main menu COS φ	Fundamental power factor	Minimum and maximum value of L1 – L2 – L3 with date and time	Min and Max
Submenu Power factor	Power factor	Minimum and maximum value of L1 – L2 – L3 with date and time	Min and Max
Submenu Total PF	Power factor total	Minimum and maximum value of the power factor total with date and time	Min and Max
Main menu Harmon.	Harmonics	Maximum values of the distortion factor of the voltage and the 3rd -19th network harmonic as well as the current harmonic contents and their sum; L1-L3.	Max

10.13 Displaying limits

Using the example of limits 1 and 2 of the phase voltage, the following section explains how to display limits.

Menu	Button(s)	Device display	Description
Main menu U _{Ph-N} Submenu Voltage Maximum	Display max/min value	<div style="display: flex; flex-direction: column; align-items: flex-start;"> <div style="margin-bottom: 10px;">235 L1</div> <div style="margin-bottom: 10px;">235 L2</div> <div>235 L3</div> </div> <div style="margin-left: 20px;"> <div style="border: 1px solid black; padding: 2px; width: 40px; text-align: center;">V</div> <ul style="list-style-type: none"> ● U_{Ph,N} ○ U_{Ph,m} ○ I ○ S ○ P ○ Q ○ cos φ ○ kWh ○ kvarh ○ THD ○ Extra </div>	<p>The maximum values that occurred for the phase voltages are shown in the Displays L1 to L3 for each phase.</p> <p>The unit display switches between MAX and V.</p>
Submenu Limit 1	<p> Press for 4 seconds for limit setting (LIM 1)</p> <p>or</p> <p> on to limit 2</p>	<div style="display: flex; flex-direction: column; align-items: flex-start;"> <div style="margin-bottom: 10px;">235 L1</div> <div style="margin-bottom: 10px;">POS L2</div> <div>OFF L3</div> </div> <div style="margin-left: 20px;"> <div style="border: 1px solid black; padding: 2px; width: 40px; text-align: center;">Lim1</div> <ul style="list-style-type: none"> ● U_{Ph,N} ○ U_{Ph,m} ○ I ○ S ○ P ○ Q ○ cos φ ○ kWh ○ kvarh ○ THD ○ Extra </div>	<p>Display L1 shows the limit.</p> <p>Display L2 shows the direction of the limit. (POS: value must not exceed this limit; NEG: value must not fall below this limit; OFF: limit deactivated.)</p> <p>Display L3 shows the message type for the limit:</p> <p>OFF: Message only via the KBR-eBus, REL1 additional message at relay 1 REL2 additional message at relay 2</p> <p>If a limit is violated, the LED of the respective main menu starts to flash.</p>
Submenu Limit 2	on to Lim1	<div style="display: flex; flex-direction: column; align-items: flex-start;"> <div style="margin-bottom: 10px;">190 L1</div> <div style="margin-bottom: 10px;">nEG L2</div> <div>OFF L3</div> </div> <div style="margin-left: 20px;"> <div style="border: 1px solid black; padding: 2px; width: 40px; text-align: center;">Lim2</div> <ul style="list-style-type: none"> ● U_{Ph,N} ○ U_{Ph,m} ○ I ○ S ○ P ○ Q ○ cos φ ○ kWh ○ kvarh ○ THD ○ Extra </div>	Description see limit 1
 NOTE	<ul style="list-style-type: none"> 	<p>Return to main menu.</p> <p>Continue to the next submenu, if available, or return to the main menu.</p>	



NOTE

If a relay is not configured as an alarm relay but as a switching relay (setting only possible via KBR-eBus), the relay concerned cannot be selected in Display L3.

The following table gives an overview of all limits available in the multimess F144-2-LED-...-5

Menu	Measured value	Programmed limits	Text displayed in de and en
Main menu U_{Ph-N}	Phase voltage	Limit 1 and limit 2 for L1 – L2 – L3	GW 1 and GW 2 Lim 1 and Lim 2
Submenu F_{power}	Network frequency	Limit 1 and limit 2	GW 1 and GW 2 Lim 1 and Lim 2
Main menu U_{Ph-Ph}	Outer conductor voltage	Limit 1 and limit 2 for L1 - L2 - L3	GW 1 and GW 2 Lim 1 and Lim 2
Main menu I_{act}	Phase current instantaneous values	Limit 1 and limit 2 for L1 - L2 - L3	GW 1 and GW 2 Lim 1 and Lim 2
Submenu I_{avg}	Average values for phase current	Limit 1 and limit 2 for L1 – L2 – L3	GW 1 and GW 2 Lim 1 and Lim 2
Submenu I_{nact}	Instantaneous value of neutral conductor current	Limit 1 and limit 2 for the instantaneous neutral conductor current	GW 1 and GW 2 Lim 1 and Lim 2
Submenu I_{Navg}	Average neutral conductor current	Limit 1 and limit 2 for the average neutral conductor current	GW 1 and GW 2 Lim 1 and Lim 2
Submenu I_{PE}	PE Leakage calculated	Limit 1 and limit 2 calculated for PE leakage	GW 1 and GW 2 Lim 1 and Lim 2
Main menu S	Apparent power	Limit 1 and limit 2 for L1 – L2 – L3	GW 1 and GW 2 Lim 1 and Lim 2
Submenu S_{TOT}	Total apparent power	Limit 1 and limit 2 for total apparent power	GW 1 and GW 2 Lim 1 and Lim 2
Main menu P	Active power	Limit 1 and limit 2 for L1 – L2 – L3	GW 1 and GW 2 Lim 1 and Lim 2
Submenu P_{TOT}	Total active power	Limit 1 and limit 2 for total active power	GW 1 and GW 2 Lim 1 and Lim 2
Main menu Q	Reactive power	Limit 1 and limit 2 for L1 – L2 – L3	GW 1 and GW 2 Lim 1 and Lim 2
Submenu Q_{TOT}	Total reactive power	Limit 1 and limit 2 for total reactive power	GW 1 and GW 2 Lim 1 and Lim 2

Continued

Menu	Measured value	Programmed limits	Text displayed in de and en
Main menu COSφ	Fundamental power factor	Limit 1 and limit 2 for L1 – L2 – L3	GW 1 and GW 2 Lim 1 and Lim 2
Submenu Power factor	Power factor	Limit 1 and limit 2 for L1 – L2 – L3	GW 1 and GW 2 Lim 1 and Lim 2
Submenu Total PF	Power factor total	Limit 1 and limit 2 for the power factor total	GW 1 and GW 2 Lim 1 and Lim 2
Main menu THD	Harmonics	Limit 1 and 2 of the distortion factor of the voltage and the 3rd to 13th network harmonic of L1-L3 as well as the current harmonic contents and their sum L1 - L3	GW 1 and GW 2 Lim 1 and Lim 2

11 Programming









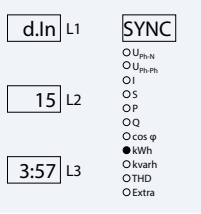

11.1 Period time current average value

Menu	Button(s)	Device display	Description
Main menu I _{act} Submenu I average Period time	▶ Hold the button for 4 seconds. ▶ Start input mode		When you open this menu, the following text is shown on the display: TIME AVERAGE CURRENT TIME Display L1 shows the period time in minutes.
Submenu I Average value Setting the period time	[23] Change value or ▶ Next digit or ⊗ Cancel or ⏪ Save		The first digit on the Display L1 flashes. Press the [23] button to set the number for this segment. Press the ▶ button to go to the next digit. You can set between 1 and 15 minutes.
 NOTE	▼ ▶	Return to main menu Continue to the next submenu, if available, or return to the main menu.	

11.2 Tariff switching method

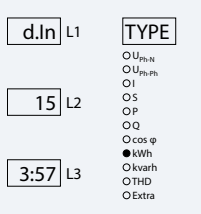
Menu	Button(s)	Device display	Description
Main menu kWh/HT Sub-menu Tariff input Tariff switching method	<p> Hold the button for 4 seconds.</p> <p> Start input mode</p>		<p>When you open this menu, the following text is shown on the display: TARF LT TARIFF TIMES</p> <p>In Display L1: Display the tariff switching method</p> <p>The following switching methods can be selected:</p> <ul style="list-style-type: none"> - d.In by external pulse - BUS via KBR-eBus command - Int by internal time program
Submenu tariff input Set tariff switching method	<p> next mode</p> <p>or</p> <p> cancel</p> <p>or</p> <p> Save</p>		<p>Display L1 flashes.</p> <p>Press the button to switch between the above operating modes.</p> <p>The unit display switches between TARF and TYPE.</p>
 NOTE	<p> or </p>	Use these buttons to switch between the displays in input mode (one digit flashes).	
Main menu kWh/HT Sub-menu Tariff input Set tariff switching time	<p> Change value</p> <p>or</p> <p> Next digit</p> <p>or</p> <p> Cancel</p> <p>or</p> <p> Save</p>		<p>With tariff switching method Int the start time can be set in Display L2 and the end time in Display L3</p>
 NOTE	<p></p> <p></p> <p> or </p>	<p>Return to main menu.</p> <p>Continue to the next submenu, if available, or Return to main menu.</p> <p>Use these buttons to switch between the displays in input mode (one digit flashes).</p>	

11.3 Measurement period synchronization

Menu	Button(s)	Device display	Description
Submenu kWh/LT Submenu Measurement period	<p> Hold the button for 4 seconds.</p> <p> Start input mode</p>	 <p>d.In L1 SYNC</p> <p>15 L2</p> <p>3:57 L3</p> <p> <input type="radio"/> U_{Ph-N} <input type="radio"/> U_{Ph-Ph} <input type="radio"/> OI <input type="radio"/> OS <input type="radio"/> OP <input type="radio"/> OQ <input type="radio"/> Ocos φ <input checked="" type="radio"/> kWh <input type="radio"/> kvarh <input type="radio"/> THD <input type="radio"/> Extra </p>	<p>When you open this menu, the following text is shown on the display: SYNC PARAMETER SYNC</p> <p>The Display L1 shows the synchronization type.</p> <p>Display L2 shows the measurement period in minutes.</p> <p>The time remaining until the next synchronization is indicated in Display L3 in minutes and seconds.</p> <p>The following synchronization types can be selected:</p> <ul style="list-style-type: none"> - Int by internal clock - d.In by external contact - BUS via KBR-eBus command - TArF by tariff switching
Submenu Measurement period Set measurement period synchronization	<p> Change value</p> <p>or</p> <p> cancel</p> <p>or</p> <p> Save</p>	 <p>d.In L1 TYPE</p> <p>15 L2</p> <p>3:57 L3</p> <p> <input type="radio"/> U_{Ph-N} <input type="radio"/> U_{Ph-Ph} <input type="radio"/> OI <input type="radio"/> OS <input type="radio"/> OP <input type="radio"/> OQ <input type="radio"/> Ocos φ <input checked="" type="radio"/> kWh <input type="radio"/> kvarh <input type="radio"/> THD <input type="radio"/> Extra </p>	<p>Display L1 flashes.</p> <p>Press the  button to switch between the above operating modes.</p>
 NOTE	<p></p> <p></p>	<p>Return to main menu.</p> <p>Continue to the next submenu, if available, or return to the main menu.</p>	

11.4 Programming limits

The following section explains how to parameterize the limits. The limits 1 and 2 of the phase voltage serve as an example.

Menu	Button(s)	Device display	Description
Sub menu Voltage U _{Ph-N} Maximum	<ul style="list-style-type: none"> Maximum Hold the button for 4 seconds. Start input mode 		<p>Display L1 shows the limit.</p> <p>Display L2 shows the direction of the limit. (POS: value must not exceed this limit; NEG: value must not fall below this limit; OFF: limit deactivated.)</p> <p>The Display L3 shows how the limit violation is communicated.</p> <ul style="list-style-type: none"> - Alarm on relay 1 (REL1) - Alarm on relay 2 (REL2) - Alarm only via KBR eBus (OFF)
Submenu Voltage U _{Ph-N} Limit 1 Set value	<ul style="list-style-type: none"> Change value or next digit or cancel or Save 		<p>The first digit on the Display L1 flashes. Press the button to set the number for this segment.</p> <p>Press the button to go to the next digit.</p> <p>Once all of the digits have been set, Display L1 flashes.</p> <p>To move the decimal point, press the button .</p> <p>The unit display switches between LIM 1 and V.</p>
 NOTE	or	Use these buttons to switch between the displays in input mode (one digit flashes).	

Menu	Button(s)	Device display	Description
Submenu Voltage U_{Ph-N} Limit 1 Set direction	next digit or cancel or Save	<div style="display: flex; flex-direction: column; align-items: flex-start;"> <div style="margin-bottom: 10px;">235 L1 Lim1</div> <div style="margin-bottom: 10px;">POS L2</div> <div>OFF L3</div> </div> <div style="font-size: 0.8em; margin-top: 10px;"> <ul style="list-style-type: none"> ● U_{Ph-N} ○ U_{Ph-Ph} ○ I ○ S ○ P ○ Q ○ cos φ ○ kWh ○ kvarh ○ THD ○ Extra </div>	Display L2 flashes. Press the button to select whether the limit is to be activated when exceeded (POS) or when the value falls below the limit (NEG) or whether it should be locked (OFF).
 NOTE	or	In input mode (one digit flashes) you can switch between the displays with these buttons.	
Submenu Voltage U_{Ph-N} Limit 1 Set message type	next digit or cancel or Save	<div style="display: flex; flex-direction: column; align-items: flex-start;"> <div style="margin-bottom: 10px;">240 L1 Lim1</div> <div style="margin-bottom: 10px;">nEG L2</div> <div>rEL1 L3</div> </div> <div style="font-size: 0.8em; margin-top: 10px;"> <ul style="list-style-type: none"> ● U_{Ph-N} ○ U_{Ph-Ph} ○ I ○ S ○ P ○ Q ○ cos φ ○ kWh ○ kvarh ○ THD ○ Extra </div>	Display L3 flashes. Use the button to determine the message type for a limit violation. <ul style="list-style-type: none"> - Alarm on relay 1 (REL1) - Alarm on relay 2 (REL2) - Alarm only via KBR eBus (OFF)
 NOTE	 or	Return to main menu. Continue to the next submenu, if available, or return to the main menu. Use these buttons to switch between the displays in input mode (one digit flashes).	



NOTE

If both relays are not configured as alarm relays but as switching relays (setting only possible via KBR-eBus), the display in L3 (OFF) cannot be changed.

11.4.1 Configuring hysteresis for limits

The following section explains how to parameterize the hysteresis of the limits. Limit 1 of the phase voltage serves as an example.

Menu	Button(s)	Device display	Description
Submenu Voltage U_{Ph-N} Limit 1	<ul style="list-style-type: none"> Maximum Hold the button for 4 seconds. Display hysteresis 	<div style="display: flex; flex-direction: column; align-items: flex-start;"> <div style="margin-bottom: 10px;"><input type="text" value="235"/> L1 Lim1</div> <div style="margin-bottom: 10px;"><input type="text" value="POS"/> L2</div> <div><input type="text" value="OFF"/> L3</div> </div> <ul style="list-style-type: none"> ● U_{Ph-N} ○ U_{Ph-Ph} ○ I ○ S ○ P ○ Q ○ cos φ ○ kWh ○ kvarh ○ THD ○ Extra 	
Display hysteresis	<ul style="list-style-type: none"> Start input mode 	<div style="display: flex; flex-direction: column; align-items: flex-start;"> <div style="margin-bottom: 10px;"><input type="text" value="05"/> L1 HYST</div> <div style="margin-bottom: 10px;"><input type="text"/> L2</div> <div><input type="text"/> L3</div> </div> <ul style="list-style-type: none"> ● U_{Ph-N} ○ U_{Ph-Ph} ○ I ○ S ○ P ○ Q ○ cos φ ○ kWh ○ kvarh ○ THD ○ Extra 	Display hysteresis in % (based on the measured value)
Submenu hysteresis Limit 1	<ul style="list-style-type: none"> Change value or Next digit 	<div style="display: flex; flex-direction: column; align-items: flex-start;"> <div style="margin-bottom: 10px;"><input type="text" value="01"/> L1 HYST</div> <div style="margin-bottom: 10px;"><input type="text"/> L2</div> <div><input type="text"/> L3</div> </div> <ul style="list-style-type: none"> ● U_{Ph-N} ○ U_{Ph-Ph} ○ I ○ S ○ P ○ Q ○ cos φ ○ kWh ○ kvarh ○ THD ○ Extra 	Change hysteresis value in % for limit 1 (setting range 1 to 99%)
	<ul style="list-style-type: none"> Save or Cancel 	<div style="display: flex; flex-direction: column; align-items: flex-start;"> <div style="margin-bottom: 10px;"><input type="text" value="05"/> L1 HYST</div> <div style="margin-bottom: 10px;"><input type="text"/> L2</div> <div><input type="text"/> L3</div> </div> <ul style="list-style-type: none"> ● U_{Ph-N} ○ U_{Ph-Ph} ○ I ○ S ○ P ○ Q ○ cos φ ○ kWh ○ kvarh ○ THD ○ Extra 	

Continued











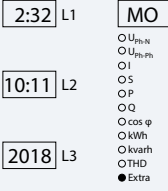

Menu	Button(s)	Device display	Description
	With [2] back to limit input.	<div style="display: flex; flex-direction: column; align-items: flex-start;"> <div style="display: flex; align-items: center; margin-bottom: 10px;"> <div style="border: 1px solid black; padding: 2px 5px; margin-right: 5px;">235</div> <div style="margin-left: 5px;">L1</div> <div style="margin-left: 20px; border: 1px solid black; padding: 2px 5px;">HYST</div> </div> <div style="margin-bottom: 10px;"> <ul style="list-style-type: none"> ● U_{Ph,N} ○ U_{Ph,Ph} ○ I ○ S ○ P ○ Q ○ cos φ ○ kWh ○ kvarh ○ THD ○ Extra </div> <div style="display: flex; align-items: center; margin-bottom: 10px;"> <div style="border: 1px solid black; padding: 2px 5px; margin-right: 5px;">POS</div> <div style="margin-left: 5px;">L2</div> </div> <div style="display: flex; align-items: center;"> <div style="border: 1px solid black; padding: 2px 5px; margin-right: 5px;">OFF</div> <div style="margin-left: 5px;">L3</div> </div> </div>	

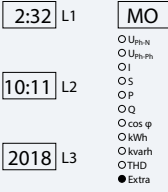















NOTE

Programming the hysteresis for limit 2 is identical.

11.5 Setting time and date

Menu	Button(s)	Device display	Description
Main menu Extra Submenu Date and time	 Start input mode		Display L1 shows the time (hh.mm). Display L2 shows the date (dd.mm). Display L3 shows the year (yyyy). The unit display shows the weekday.
Submenu Set date and time	 Change value  next digit or  Save or  Cancel		The first two digits in Display L1 flash. Press the  button to set the number for this segment. Press the  button to go to the next digit. To set the day and month in Display L2, proceed as described for Display L1. The same applies to the year in Display L3.
 NOTE	   or 	Return to main menu Continue to the next submenu, if available, or Return to main menu. Use these buttons to switch between the displays in input mode (one digit flashes).	

11.6 Setting the bus address

Menu	Button(s)	Device display	Description
Main menu Extra eBus submenu	 Start input mode (bus scan)	<div style="display: flex; flex-direction: column; align-items: flex-start;"> <div style="display: flex; align-items: center; margin-bottom: 10px;"> <div style="border: 1px solid black; padding: 2px 5px; margin-right: 5px;">0001</div> <div style="margin-right: 5px;">L1</div> <div style="margin-left: 20px; border: 1px solid black; padding: 2px 5px;">EBUS</div> </div> <div style="font-size: 8px; margin-bottom: 10px;"> <ul style="list-style-type: none"> <input type="radio"/> U_{Ph-N} <input type="radio"/> U_{Ph-Pb} <input type="radio"/> OI <input type="radio"/> OS <input type="radio"/> OP <input type="radio"/> OQ <input type="radio"/> Ocos-φ <input type="radio"/> KWWh <input type="radio"/> Kvarh <input type="radio"/> THD <input checked="" type="radio"/> Extra </div> <div style="display: flex; align-items: center; margin-bottom: 10px;"> <div style="border: 1px solid black; padding: 2px 5px; margin-right: 5px;">38.4</div> <div style="margin-right: 5px;">L2</div> </div> <div style="display: flex; align-items: center;"> <div style="border: 1px solid black; padding: 2px 5px; margin-right: 5px; width: 30px; height: 20px;"></div> <div style="margin-right: 5px;">L3</div> </div> </div>	Display L1 shows the device address. The baud rate is displayed on Display L2.
eBus submenu Assign address	 Start input mode	<div style="display: flex; flex-direction: column; align-items: flex-start;"> <div style="display: flex; align-items: center; margin-bottom: 10px;"> <div style="border: 1px solid black; padding: 2px 5px; margin-right: 5px;">SCAN</div> <div style="margin-right: 5px;">L1</div> <div style="margin-left: 20px; border: 1px solid black; padding: 2px 5px;">EBUS</div> </div> <div style="font-size: 8px; margin-bottom: 10px;"> <ul style="list-style-type: none"> <input type="radio"/> U_{Ph-N} <input type="radio"/> U_{Ph-Pb} <input type="radio"/> OI <input type="radio"/> OS <input type="radio"/> OP <input type="radio"/> OQ <input type="radio"/> Ocos-φ <input type="radio"/> KWWh <input type="radio"/> Kvarh <input type="radio"/> THD <input checked="" type="radio"/> Extra </div> <div style="display: flex; align-items: center; margin-bottom: 10px;"> <div style="border: 1px solid black; padding: 2px 5px; margin-right: 5px;">38.4</div> <div style="margin-right: 5px;">L2</div> </div> <div style="display: flex; align-items: center;"> <div style="border: 1px solid black; padding: 2px 5px; margin-right: 5px; width: 30px; height: 20px;"></div> <div style="margin-right: 5px;">L3</div> </div> </div>	Display L1 indicates that the device is in scan mode. As soon as the device is recognized at the KBR eBus, an address is assigned automatically by the software and the address is entered in the device memory. The baud rate is displayed on Display L2.
 NOTE	 or 	Use these buttons to switch between the individual displays in input mode (one digit flashes).	
eBus sub- menu Assign ad- dress manually	 Change value or  Next digit or  Cancel or  Save	<div style="display: flex; flex-direction: column; align-items: flex-start;"> <div style="display: flex; align-items: center; margin-bottom: 10px;"> <div style="border: 1px solid black; padding: 2px 5px; margin-right: 5px;">0001</div> <div style="margin-right: 5px;">L1</div> <div style="margin-left: 20px; border: 1px solid black; padding: 2px 5px;">EBUS</div> </div> <div style="font-size: 8px; margin-bottom: 10px;"> <ul style="list-style-type: none"> <input type="radio"/> U_{Ph-N} <input type="radio"/> U_{Ph-Pb} <input type="radio"/> OI <input type="radio"/> OS <input type="radio"/> OP <input type="radio"/> OQ <input type="radio"/> Ocos-φ <input type="radio"/> KWWh <input type="radio"/> Kvarh <input type="radio"/> THD <input checked="" type="radio"/> Extra </div> <div style="display: flex; align-items: center; margin-bottom: 10px;"> <div style="border: 1px solid black; padding: 2px 5px; margin-right: 5px;">38.4</div> <div style="margin-right: 5px;">L2</div> </div> <div style="display: flex; align-items: center;"> <div style="border: 1px solid black; padding: 2px 5px; margin-right: 5px; width: 30px; height: 20px;"></div> <div style="margin-right: 5px;">L3</div> </div> </div>	The first digit on the Display L1 flashes. Press the  button to set the num- ber for this segment. Press the  button to go to the next digit.
 NOTE	 	Return to main menu. Continue to the next submenu, if available, or return to the main menu.	

11.7 Setting the bus protocol

Menu	Button(s)	Device display	Description
eBus submenu	Start input mode (bus scan)	<div style="display: flex; flex-direction: column; align-items: flex-start;"> <div style="display: flex; align-items: center; margin-bottom: 5px;"> <div style="border: 1px solid black; padding: 2px 5px; margin-right: 5px;">0001</div> <div style="margin-right: 5px;">L1</div> <div style="margin-left: 20px;"> <div style="border: 1px solid black; padding: 2px 5px; display: inline-block;">EBUS</div> <ul style="list-style-type: none"> <input type="radio"/> U_{FN}N <input type="radio"/> U_{FN}m <input type="radio"/> I <input type="radio"/> S <input type="radio"/> P <input type="radio"/> Q <input type="radio"/> cos p <input type="radio"/> kWh <input type="radio"/> kWh <input type="radio"/> THD <input checked="" type="radio"/> Extra </div> </div> <div style="display: flex; align-items: center; margin-bottom: 5px;"> <div style="border: 1px solid black; padding: 2px 5px; margin-right: 5px;">38.4</div> <div style="margin-right: 5px;">L2</div> </div> <div style="display: flex; align-items: center;"> <div style="border: 1px solid black; padding: 2px 5px; margin-right: 5px; width: 40px; height: 20px;"></div> <div style="margin-right: 5px;">L3</div> </div> </div>	<p>Display L1 shows the device address. The baud rate is displayed on Display L2.</p> <p>The unit display shows the current bus protocol (e. g. eBus)</p>
eBus submenu Assign address	Start input mode	<div style="display: flex; flex-direction: column; align-items: flex-start;"> <div style="display: flex; align-items: center; margin-bottom: 5px;"> <div style="border: 1px solid black; padding: 2px 5px; margin-right: 5px;">SCAN</div> <div style="margin-right: 5px;">L1</div> <div style="margin-left: 20px;"> <div style="border: 1px solid black; padding: 2px 5px; display: inline-block;">EBUS</div> <ul style="list-style-type: none"> <input type="radio"/> U_{FN}N <input type="radio"/> U_{FN}m <input type="radio"/> I <input type="radio"/> S <input type="radio"/> P <input type="radio"/> Q <input type="radio"/> cos p <input type="radio"/> kWh <input type="radio"/> kWh <input type="radio"/> THD <input checked="" type="radio"/> Extra </div> </div> <div style="display: flex; align-items: center; margin-bottom: 5px;"> <div style="border: 1px solid black; padding: 2px 5px; margin-right: 5px;">38.4</div> <div style="margin-right: 5px;">L2</div> </div> <div style="display: flex; align-items: center;"> <div style="border: 1px solid black; padding: 2px 5px; margin-right: 5px; width: 40px; height: 20px;"></div> <div style="margin-right: 5px;">L3</div> </div> </div>	<p>Display L1 indicates that the device is in scan mode.</p> <p>Press the button to enter the input mode for setting the bus protocol.</p>
eBus submenu Changing the bus protocol	<input checked="" type="checkbox"/> To change the bus protocol Changing the bus protocol	<div style="display: flex; flex-direction: column; align-items: flex-start;"> <div style="display: flex; align-items: center; margin-bottom: 5px;"> <div style="border: 1px solid black; padding: 2px 5px; margin-right: 5px;">0001</div> <div style="margin-right: 5px;">L1</div> <div style="margin-left: 20px;"> <div style="border: 1px solid black; padding: 2px 5px; display: inline-block;">EBUS</div> <ul style="list-style-type: none"> <input type="radio"/> U_{FN}N <input type="radio"/> U_{FN}m <input type="radio"/> I <input type="radio"/> S <input type="radio"/> P <input type="radio"/> Q <input type="radio"/> cos p <input type="radio"/> kWh <input type="radio"/> kWh <input type="radio"/> THD <input checked="" type="radio"/> Extra </div> </div> <div style="display: flex; align-items: center; margin-bottom: 5px;"> <div style="border: 1px solid black; padding: 2px 5px; margin-right: 5px;">38.4</div> <div style="margin-right: 5px;">L2</div> </div> <div style="display: flex; align-items: center;"> <div style="border: 1px solid black; padding: 2px 5px; margin-right: 5px; width: 40px; height: 20px;"></div> <div style="margin-right: 5px;">L3</div> </div> </div>	<p>The first digit on Display L1 flashes. The bus protocol display flashes (EBUS). The button can be used to change the bus protocol, for example:</p> <ul style="list-style-type: none"> KBR eBus (serial) Modbus RTU (serial) Modbus TCP (optional) KBR eBus TCP (optional) Profibus (optional)
eBus sub-menu Save bus protocol	<input checked="" type="checkbox"/> Cancel or <input checked="" type="checkbox"/> Save	<div style="display: flex; flex-direction: column; align-items: flex-start;"> <div style="display: flex; align-items: center; margin-bottom: 5px;"> <div style="border: 1px solid black; padding: 2px 5px; margin-right: 5px;">0001</div> <div style="margin-right: 5px;">L1</div> <div style="margin-left: 20px;"> <div style="border: 1px solid black; padding: 2px 5px; display: inline-block;">MBUS</div> <ul style="list-style-type: none"> <input type="radio"/> U_{FN}N <input type="radio"/> U_{FN}m <input type="radio"/> I <input type="radio"/> S <input type="radio"/> P <input type="radio"/> Q <input type="radio"/> cos p <input type="radio"/> kWh <input type="radio"/> kWh <input type="radio"/> THD <input checked="" type="radio"/> Extra </div> </div> <div style="display: flex; align-items: center; margin-bottom: 5px;"> <div style="border: 1px solid black; padding: 2px 5px; margin-right: 5px;">19.2</div> <div style="margin-right: 5px;">L2</div> </div> <div style="display: flex; align-items: center;"> <div style="border: 1px solid black; padding: 2px 5px; margin-right: 5px; width: 40px; height: 20px; text-align: center;">rtu</div> <div style="margin-right: 5px;">L3</div> </div> </div>	<p>The display indicates the selected bus protocol, e.g. Modbus RTU.</p> <p>The baud rate is displayed on display 2.</p> <p>Display 3 shows the Modbus protocol (RTU).</p>
<p>NOTE</p>	<input checked="" type="checkbox"/> <input checked="" type="checkbox"/>	<p>Return to main menu.</p> <p>Continue to the next submenu, if available, or return to the main menu.</p>	

24315_EDEBA0264-1419-1_EN

11.8 Setting the Modbus bus address and baud rate

Menu	Button(s)	Device display	Description
Modbus submenu	Start input mode	<div style="display: flex; flex-direction: column; align-items: flex-start;"> <div style="display: flex; align-items: center; margin-bottom: 5px;"> <div style="border: 1px solid black; padding: 2px 5px; margin-right: 5px;">0001</div> <div style="margin-right: 5px;">L1</div> <div style="border: 1px solid black; padding: 2px 5px; margin-right: 5px;">MBUS</div> <div style="font-size: 8px; margin-left: 5px;"> <ul style="list-style-type: none"> <input type="radio"/> U_{7b-N} <input type="radio"/> U_{7b-FS} <input type="radio"/> OI <input type="radio"/> OS <input type="radio"/> OP <input type="radio"/> OQ <input type="radio"/> ccs ep <input type="radio"/> kWh <input type="radio"/> kvarh <input type="radio"/> THD <input checked="" type="radio"/> Extra </div> </div> <div style="display: flex; align-items: center; margin-bottom: 5px;"> <div style="border: 1px solid black; padding: 2px 5px; margin-right: 5px;">19.2</div> <div style="margin-right: 5px;">L2</div> </div> <div style="display: flex; align-items: center;"> <div style="border: 1px solid black; padding: 2px 5px; margin-right: 5px;">rtu</div> <div>L3</div> </div> </div>	Display L1 shows the device address. The baud rate is displayed on Display L2. Display L3 shows the selected bus protocol (RTU or ASC).
Modbus submenu Assign address	Change value or Next digit or Cancel or Save	<div style="display: flex; flex-direction: column; align-items: flex-start;"> <div style="display: flex; align-items: center; margin-bottom: 5px;"> <div style="border: 1px solid black; padding: 2px 5px; margin-right: 5px;">0001</div> <div style="margin-right: 5px;">L1</div> <div style="border: 1px solid black; padding: 2px 5px; margin-right: 5px;">MBUS</div> <div style="font-size: 8px; margin-left: 5px;"> <ul style="list-style-type: none"> <input type="radio"/> U_{7b-N} <input type="radio"/> U_{7b-FS} <input type="radio"/> OI <input type="radio"/> OS <input type="radio"/> OP <input type="radio"/> OQ <input type="radio"/> ccs ep <input type="radio"/> kWh <input type="radio"/> kvarh <input type="radio"/> THD <input checked="" type="radio"/> Extra </div> </div> <div style="display: flex; align-items: center; margin-bottom: 5px;"> <div style="border: 1px solid black; padding: 2px 5px; margin-right: 5px;">19.2</div> <div style="margin-right: 5px;">L2</div> </div> <div style="display: flex; align-items: center;"> <div style="border: 1px solid black; padding: 2px 5px; margin-right: 5px;">rtu</div> <div>L3</div> </div> </div>	The first digit on the Display L1 flashes. Press the button to set the number for this segment. Press the button to go to the next digit.
 NOTE	or	In input mode (one digit flashes) you can switch between the displays with these buttons.	
Modbus submenu Assign transmission mode	Next mode or Cancel or Save	<div style="display: flex; flex-direction: column; align-items: flex-start;"> <div style="display: flex; align-items: center; margin-bottom: 5px;"> <div style="border: 1px solid black; padding: 2px 5px; margin-right: 5px;">0001</div> <div style="margin-right: 5px;">L1</div> <div style="border: 1px solid black; padding: 2px 5px; margin-right: 5px;">MBUS</div> <div style="font-size: 8px; margin-left: 5px;"> <ul style="list-style-type: none"> <input type="radio"/> U_{7b-N} <input type="radio"/> U_{7b-FS} <input type="radio"/> OI <input type="radio"/> OS <input type="radio"/> OP <input type="radio"/> OQ <input type="radio"/> ccs ep <input type="radio"/> kWh <input type="radio"/> kvarh <input type="radio"/> THD <input checked="" type="radio"/> Extra </div> </div> <div style="display: flex; align-items: center; margin-bottom: 5px;"> <div style="border: 1px solid black; padding: 2px 5px; margin-right: 5px;">19.2</div> <div style="margin-right: 5px;">L2</div> </div> <div style="display: flex; align-items: center;"> <div style="border: 1px solid black; padding: 2px 5px; margin-right: 5px;">rtu</div> <div>L3</div> </div> </div>	Display L3 flashes. Press the button to choose between the different modes (RTU or ASC).
 NOTE	or	In input mode (one digit flashes) you can switch between the displays with these buttons.	

Continued overleaf

Continued

<p>Modbus sub-menu</p> <p>Assign baud rate</p>	<p> Next Baud rate</p> <p>or</p> <p> Cancel</p> <p>or</p> <p> Save</p>	<p><input type="text" value="0001"/> L1 <input type="text" value="MBUS"/></p> <p><input type="text" value="19.2"/> L2</p> <p><input type="text" value="rtu"/> L3</p> <p><small>○ U_{PrN} ○ U_{Prm} ○ I ○ S ○ P ○ Q ○ cos φ ○ kWh ○ kvarh ○ THD ● Extra</small></p>	<p>Display L2 flashes.</p> <p>Press the button to choose from different baud rates with the respective even/odd parity or no parity.</p> <p>4.8 k baud 9.6 k baud 19.2 k baud</p>
<p></p> <p>NOTE</p>	<p></p> <p></p> <p> or </p>	<p>Return to main menu Continue to the next submenu, if available, or Return to main menu. Use these buttons to switch between the displays in input mode (one digit flashes).</p>	

11.9 Setting the relay on-delay and off-delay

Menu	Button(s)	Device display	Description
<p>Submenu REL 1</p>	<p> Start input mode</p>	<p><input type="text" value="010"/> L1 <input type="text" value="REL1"/></p> <p><input type="text" value="020"/> L2</p> <p><input type="text" value=""/> L3</p> <p><small>○ U_{PrN} ○ U_{Prm} ○ I ○ S ○ P ○ Q ○ cos φ ○ kWh ○ kvarh ○ THD ● Extra</small></p>	<p>Display L1 shows the on-delay for relay 1 in seconds. Display L2 shows the off-delay for relay 1 in seconds. The unit display switches between REL1 and tON.</p>
<p>Submenu REL 1</p> <p>Set on-delay</p>	<p> Change value</p> <p>or</p> <p> Next digit</p> <p>or</p> <p> Cancel</p> <p>or</p> <p> Save</p>	<p><input type="text" value="080"/> L1 <input type="text" value="REL1"/></p> <p><input type="text" value="020"/> L2</p> <p><input type="text" value=""/> L3</p> <p><small>○ U_{PrN} ○ U_{Prm} ○ I ○ S ○ P ○ Q ○ cos φ ○ kWh ○ kvarh ○ THD ● Extra</small></p>	<p>The first digit on the Display L1 flashes. Press the button to set the number for this segment. (max. 255 sec.)</p> <p>Press the button to go to the next digit.</p>
<p></p> <p>NOTE</p>	<p> or </p>	<p>In input mode (one digit flashes) you can switch between the displays with these buttons.</p>	

Continued overleaf

Continued

<p>Submenu REL 1</p> <p>Set off-delay</p>	<p> Change value</p> <p>or</p> <p> Next digit</p> <p>or</p> <p> Cancel</p> <p>or</p> <p> Save</p>	<p><input type="text" value="080"/> L1 <input type="text" value="REL1"/></p> <p><input type="text" value="100"/> L2</p> <p><input type="text"/> L3</p> <p> <input type="radio"/> U_{Ph-N} <input type="radio"/> U_{Ph-PB} <input type="radio"/> I <input type="radio"/> S <input type="radio"/> P <input type="radio"/> Q <input type="radio"/> cos φ <input type="radio"/> kWh <input type="radio"/> kvarh <input type="radio"/> THD <input checked="" type="radio"/> Extra </p>	<p>The first digit on Display L2 flashes. Press the button to set the number for this segment. (max. 255 sec.)</p> <p>Press the button to go to the next digit.</p> <p>The assignment as switching relay is shown in Display L1 ----, L2 ---- and L3 BUS.</p> <p>Configuration is only possible via KBR eBus using optionally available software.</p>
<p></p> <p>NOTE</p>	<p></p> <p></p> <p> or </p>	<p>Return to main menu</p> <p>Continue to the next submenu, if available, or Return to main menu.</p> <p>Use these buttons to switch between the displays in input mode (one digit flashes).</p>	



NOTE

Relay 2 is set the same way as relay 1.

11.10 Activating daylight saving time

Menu	Button(s)	Device display	Description
Submenu Daylight sav- ing time	Start input mode	<div style="display: flex; flex-direction: column; align-items: flex-start;"> <div style="display: flex; align-items: center; margin-bottom: 10px;"> <div style="border: 1px solid black; padding: 2px 5px; margin-right: 5px;">ON</div> <div style="margin-right: 5px;">L1</div> <div style="border: 1px solid black; padding: 2px 5px; margin-right: 5px;">DST</div> </div> <div style="font-size: 8px; margin-bottom: 10px;"> <ul style="list-style-type: none"> O U_{PhN}N O U_{PhM}M O I O S O P O Q O cos φ O kWh O kvarh O THD ● Extra </div> <div style="display: flex; align-items: center; margin-bottom: 10px;"> <div style="border: 1px solid black; padding: 2px 5px; margin-right: 5px;">03</div> <div style="margin-right: 5px;">L2</div> </div> <div style="display: flex; align-items: center;"> <div style="border: 1px solid black; padding: 2px 5px; margin-right: 5px;">10</div> <div style="margin-right: 5px;">L3</div> </div> </div>	<p>Display L1 indicates, whether daylight saving time is activated or not.</p> <p>Display L2: shows the month daylight saving time begins.</p> <p>Display L3: shows the month daylight saving time ends.</p> <p>The unit display shows Daylight saving and then DST</p>
Submenu Daylight sav- ing time on/off	Change value or Cancel or Save	<div style="display: flex; flex-direction: column; align-items: flex-start;"> <div style="display: flex; align-items: center; margin-bottom: 10px;"> <div style="border: 1px solid black; padding: 2px 5px; margin-right: 5px;">ON</div> <div style="margin-right: 5px;">L1</div> <div style="border: 1px solid black; padding: 2px 5px; margin-right: 5px;">DST</div> </div> <div style="font-size: 8px; margin-bottom: 10px;"> <ul style="list-style-type: none"> O U_{PhN}N O U_{PhM}M O I O S O P O Q O cos φ O kWh O kvarh O THD ● Extra </div> <div style="display: flex; align-items: center; margin-bottom: 10px;"> <div style="border: 1px solid black; padding: 2px 5px; margin-right: 5px;">03</div> <div style="margin-right: 5px;">L2</div> </div> <div style="display: flex; align-items: center;"> <div style="border: 1px solid black; padding: 2px 5px; margin-right: 5px;">10</div> <div style="margin-right: 5px;">L3</div> </div> </div>	<p>Display L1 flashes.</p> <p>Press the button to activate (on) or deactivate (off) daylight saving time.</p>
 NOTE	or	<p>In input mode (one digit flashes) you can switch between the displays with these buttons.</p>	
Submenu Daylight sav- ing time on/off Start	Change value or Cancel or Save	<div style="display: flex; flex-direction: column; align-items: flex-start;"> <div style="display: flex; align-items: center; margin-bottom: 10px;"> <div style="border: 1px solid black; padding: 2px 5px; margin-right: 5px;">ON</div> <div style="margin-right: 5px;">L1</div> <div style="border: 1px solid black; padding: 2px 5px; margin-right: 5px;">DST</div> </div> <div style="font-size: 8px; margin-bottom: 10px;"> <ul style="list-style-type: none"> O U_{PhN}N O U_{PhM}M O I O S O P O Q O cos φ O kWh O kvarh O THD ● Extra </div> <div style="display: flex; align-items: center; margin-bottom: 10px;"> <div style="border: 1px solid black; padding: 2px 5px; margin-right: 5px;">03</div> <div style="margin-right: 5px;">L2</div> </div> <div style="display: flex; align-items: center;"> <div style="border: 1px solid black; padding: 2px 5px; margin-right: 5px;">10</div> <div style="margin-right: 5px;">L3</div> </div> </div>	<p>Display L2 flashes.</p> <p>Press the button to set the month daylight saving time begins.</p> <p>The unit display switches between BEG. and DST.</p>
 NOTE	or	<p>In input mode (one digit flashes) you can switch between the displays with these buttons.</p>	

Continued

Menu	Button(s)	Device display	Description
Submenu Daylight sav- ing time on/off End	Change value or Cancel or Save		Display L3 flashes. Press the button to set the month daylight saving time ends. The unit display switched between END and DST.
 NOTE	 or	Return to main menu Continue to the next submenu, if available, or Return to main menu. Use these buttons to switch between the displays in input mode (one digit flashes).	

11.11 Language settings

Menu	Button(s)	Device display	Description
Submenu Language	Start input mode		Display L1 flashes. For German, it displays: ENGL For English, it displays: ENGL The unit display shows SPRA if the user language is German and LANG if it is English.
Submenu Language set	Change value or Cancel or Save		Display L1 shows the user lan- guage. Press the button to select the operating language. For German, it displays: ENGL For English, it displays: ENGL The unit display shows SPRA if the user language is German and LANG if it is English.
 NOTE	 	Return to main menu Continue to the next submenu, if available, or return to the main menu.	

24315_EDEBD00264-1419-1_EN

11.12 Password

Menu	Button(s)	Device display	Description
Submenu Password	Start input mode	<div style="display: flex; justify-content: space-between;"> <div style="width: 45%;"> <p>COdE L1</p> <p>---- L2</p> <p> L3</p> </div> <div style="width: 45%; border: 1px solid black; padding: 5px;"> <p>LOCK</p> <p><small>○ U_{pin}N</small></p> <p><small>○ U_{pin}m</small></p> <p><small>○ I</small></p> <p><small>○ S</small></p> <p><small>○ P</small></p> <p><small>○ Q</small></p> <p><small>○ cos p</small></p> <p><small>○ kWh</small></p> <p><small>○ kWh</small></p> <p><small>○ THD</small></p> <p><small>● Extra</small></p> </div> </div>	<p>Display L1 shows CODE.</p> <p>The unit display shows LOCK or FREE.</p> <p>L2 shows ----</p> <p>The device is defaulted with the code 9999, i.e. all functions of the device are available.</p>
Submenu Password set	Change value or Next digit or Cancel or Save	<div style="display: flex; justify-content: space-between;"> <div style="width: 45%;"> <p>COdE L1</p> <p>9999 L2</p> <p> L3</p> </div> <div style="width: 45%; border: 1px solid black; padding: 5px;"> <p>LOCK</p> <p><small>○ U_{pin}N</small></p> <p><small>○ U_{pin}m</small></p> <p><small>○ I</small></p> <p><small>○ S</small></p> <p><small>○ P</small></p> <p><small>○ Q</small></p> <p><small>○ cos p</small></p> <p><small>○ kWh</small></p> <p><small>○ kWh</small></p> <p><small>○ THD</small></p> <p><small>● Extra</small></p> </div> </div>	<p>Display L1 shows CODE.</p> <p>The unit display shows LOCK or FREE.</p> <p>Display L2 shows 9999. The first position on Display L2 flashes.</p> <p>Press the button to set the number for this segment.</p> <p>Press the button to go to the next digit.</p>
 NOTE	 	<p>Return to main menu</p> <p>Continue to the next submenu, if available, or return to the main menu.</p>	



NOTE

If the password should get lost, the device can be unlocked with the master password 1976.

In the configuration of a password protected device, wait for a maximum of 300 seconds to press the first button after the controller has been unlocked. If no buttons are pressed during this time, the controller is then locked again.

After a power supply failure, the device is password protected again.

After the default settings are reset, the password protection is lifted.

11.13 Configuring the pulse output

Menu	Button(s)	Device display	Description
Submenu Pulse output	Start input mode		<p>Display L1 indicates , whether the pulse output is deactivated (OFF) or configured for active (P) or reactive (Q) energy.</p> <p>Display L2 shows the pulse value, i.e. pulse/kWh or kvarh (z.B. 1,000 for 1 pulse/kWh).</p> <p>Display L3 shows the energy pulse length in msec.</p>
Submenu Pulse output Set pulse source	Change value or Cancel or Save		<p>When you open this menu, the following text is shown on the display: SRC. SOURCE</p> <p>Display L1 flashes.</p> <p>Press the button to select the active energy (P consumption or P- recovery), the reactive energy (Q consumption or Q- recovery) or deactivate (OFF) the energy pulse.</p>
 NOTE	or	In input mode (one digit flashes) you can switch between the displays with these buttons.	
Submenu Pulse output Set pulse significance	Change value or Next digit or Cancel or Save		<p>When you open the menu, the following text is displayed in the unit display: VAL. VALENCY VAL.</p> <p>The first digit on Display L2 flashes.</p> <p>Press the button to set the number for this segment.</p> <p>If all digits are flashing, you can move the decimal point with the button.</p>
 NOTE	or	In input mode (one digit flashes) you can switch between the displays with these buttons.	

24315_EDEBD00264-1419-1_EN

Continued

Menu	Button(s)	Device display	Description
Submenu Pulse output Set pulse length	Change value or Next digit or Cancel or Save		When you open the menu, the following text is displayed in the unit display: LEN. LENGTH LEN The first digit in Display L3 flashes. Press the button to set the number for this segment.
NOTE	 or	Return to main menu Continue to the next submenu, if available, or Return to main menu. Use these buttons to switch between the displays in input mode (one digit flashes).	



NOTE

If the “Extra” LED flashes after the pulse significance is entered, follow the instructions below. The “Extra” LED flashes until a matching (lower) pulse count or pulse length is entered.

Check the pulse significance in relation to the pulse length. Correct the pulse length or the pulse significance if required.

The maximum processable active or reactive energy can be estimated with the following calculation.

$$\frac{3600 \text{ s}}{2 \times \text{IL} \times \text{pulse/kWh (kvarh)}} = \text{Maximum value}$$

Explanation:

- 3600 Constant [s]
- IL Required pulse length [s]
- pulse/kWh (kvarh) Required pulse count per kWh or per kvarh [pulse/kWh or pulse/kvarh]
- Maximum value Maximum output active or reactive energy [kWh or kvarh].







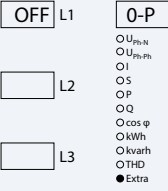

11.14 Damping coefficient

Menu	Button(s)	Device display	Description
Submenu Damp. Factor DF	Start input mode		Display L1 shows the damping coefficient for acquiring the voltage. Display L2 shows the damping coefficient for acquiring the current.
Submenu Damp. coefficient Set DF voltage	Change value or Cancel or Save		When you open the menu, the following text is displayed in the unit display: DF DAMPINGFACTOR DF The first digit on the Display L1 flashes. Press the button to set the number for this segment. Range of values: 0 - 6
 NOTE	or	In input mode (one digit flashes) you can switch between the displays with these buttons.	
Submenu Damp. coefficient Set DF current	Change value or Cancel or Save		The first digit on Display L2 flashes. Press the button to set the number for this segment. Range of values: 0 - 6
 NOTE	 or	Return to main menu Continue to the next submenu, if available, or Return to main menu. Use these buttons to switch between the displays in input mode (one digit flashes).	

11.15 Default settings

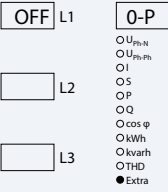
Menu	Button(s)	Device display	Description
Submenu Default settings			The unit display shows DEF.
Submenu Default settings Reset to default settings	 at the same time		When you press these three buttons at the same time, the following text is shown in the unit display: KILL.
 NOTE		Return to main menu Continue to the next submenu, if available, or return to the main menu.	

11.16 Zero point creator

Menu	Button(s)	Device display	Description
Submenu Zero point creator	 Start input mode		Display L1 shows the state of the zero point creator.
Submenu Zero point creator activate	 Change value or  Cancel or  Save		When you open the menu: Display L1 flashes. Press the  button to activate this function. Range of values: OFF, ON.
 NOTE	 	Return to main menu. Continue to the next submenu, if available, or return to the main menu.	

11.17 Analog outputs (option)

Menu	Button(s)	Device display	Description
Submenu Analog outputs	Start input mode		Display L1 shows the output value of the analog outputs 1 to 3.
Submenu Analog outputs Set output type	Change value or Cancel or Save		When you open the menu, 4-20 flashes in Display L1. Press the to select the output type. Range of values: 0 - 20 mA 4 - 20 mA 0 - 10 V 2 - 10 V
 NOTE	 	Return to main menu. Continue to the next submenu, if available, or return to the main menu.	
next submenu	Start input mode		
Submenu Analog out- puts Activate output 1 and select output data point	Change value or Cancel or Save		When you open the menu, OFF flashes in the unit display. Press the button to activate the output and to set the output data point. Range of values: see following output data points
 NOTE	or	In input mode (one digit flashes) you can switch between the displays with these buttons.	

The following output data points are available:

Off (output deactivated)

Voltage U PH-N L1

Voltage U PH-N L2

Voltage U PH-N L3

Voltage U PH-PH L12

Voltage U PH-PH L23

Voltage U PH-PH L31

Apparent current Is L1

Apparent current Is L2

Apparent current Is L3

Average apparent current L1

Average apparent current L2

Average apparent current L3

Apparent power L1

Apparent power L2

Apparent power L3

Active power L1

Active power L2

Active power L3

Reactive power L1

Reactive power L2

Reactive power L3

CosPhi L1

CosPhi L2

CosPhi L3

Power factor L1

Power factor L2

Power factor L3

Network frequency

Neutral conductor current











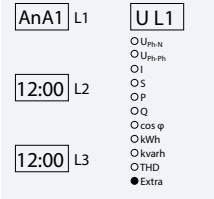





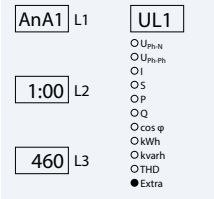



Average neutral conductor current

Total apparent power

Total active power

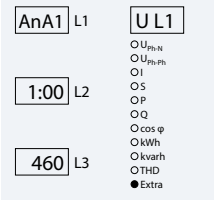
Total reactive power

Total power factor

Menu	Button(s)	Device display	Description
Submenu Analog outputs Set lower limit			<p>Display L1 shows the analog output 1.</p> <p>Display L2 shows the lower limit and flashes (0 . 00)</p> <p>Display L3 shows the upper limit.</p>
 NOTE	 or 	<p>In input mode (one digit flashes) you can switch between the</p> <p>displays with these buttons.</p>	
Submenu Analog outputs Set lower limit	 Change value or  Cancel or  Save		<p>The first digit on Display L2 flashes. Press the  button to set the number for this segment.</p> <p>Press the  button to switch between the individual digits. If all digits are flashing, you can move the decimal point with the  button. The unit display is also changed.</p>
 NOTE	 or 	<p>In input mode (one digit flashes) you can switch between the</p> <p>displays with these buttons.</p>	
Submenu Analog outputs Set upper limit	 Change value or  Cancel or  Save		<p>The first digit in Display L3 flashes. Press the  button to set the number for this segment.</p> <p>Press the  button to switch between the individual digits.</p> <p>If all digits are flashing, you can move the decimal point with the  button. The unit display is also changed.</p>

Continued

Menu	Button(s)	Device display	Description
next submenu	Start input mode		
Submenu Analog outputs Activate output 2 and select output data point	Change value or Cancel or Save		When you open the menu, OFF flashes in the unit display. Press the button to set the output data point.



NOTE

The analog outputs AnA.2 and AnA.3 can be set the same way as analog output AnA.1

11.18 Key sounds (button buzzer)



Menu	Button(s)	Device display	Description
Submenu button buzzer	Start input mode	<div style="display: flex; flex-direction: column; align-items: flex-start;"> <div style="display: flex; align-items: center; margin-bottom: 10px;"> <input type="checkbox"/> ON L1 <div style="margin-left: 20px;"> TOTAL <small>U_{ph,N} U_{ph,ph} I S P Q cos φ kWh kvarh THD ●Extra</small> </div> </div> <div style="display: flex; align-items: center; margin-bottom: 10px;"> <input type="checkbox"/> L2 </div> <div style="display: flex; align-items: center;"> <input type="checkbox"/> L3 </div> </div>	Display L1 shows the state of the button buzzer.
Activate/deactivate submenu buttons summer	Change value or Cancel or Save	<div style="display: flex; flex-direction: column; align-items: flex-start;"> <div style="display: flex; align-items: center; margin-bottom: 10px;"> <input type="checkbox"/> OFF L1 <div style="margin-left: 20px;"> TOTAL <small>U_{ph,N} U_{ph,ph} I S P Q cos φ kWh kvarh THD ●Extra</small> </div> </div> <div style="display: flex; align-items: center; margin-bottom: 10px;"> <input type="checkbox"/> L2 </div> <div style="display: flex; align-items: center;"> <input type="checkbox"/> L3 </div> </div>	When you open the menu: Display L1 flashes. Press the button to activate this function. Range of values: ON, OFF
NOTE	 	Return to main menu. Continue to the next submenu, if available, or return to the main menu.	

11.19 Default menu (start selection)

Menu	Button(s)	Device display	Description
Submenu Default menu (start selection)	Start input mode		<p>Display L1 shows the selected default menu (02 = U_{PH-PH}).</p> <p>Display L2 shows the return time in seconds to the default menu.</p>
Submenu Default menu (start selection)	Change value or Cancel or Save		<p>Display L1 flashes.</p> <p>Press the button to select the default menu</p> <p>Range of values: 01 to 11, the LED on the selected menu flashes.</p>
Submenu Default menu (start selection) set return time	Change value or Next digit or Cancel or Save		<p>The first digit on Display L2 flashes.</p> <p>Set the return time to the default menu from 0 seconds (0 = function deactivated) to 255 seconds.</p>
 NOTE	 or	<p>Return to main menu</p> <p>Continue to the next submenu, if available, or Return to main menu.</p> <p>Use these buttons to switch between the displays in input mode (one digit flashes).</p>	

12 Reset and delete function

12.1 Reset

<p> +  + </p> <p>Only reset the energy meter during setup or if the device is completely reprogrammed</p> <p>Caution! Reset will reset all programmed values to the default settings!</p>	<p>To reset, go to the Default settings submenu of the Extra menu.</p> <p>Hold the buttons digit, delete and right arrow at the same time. The 15-segment display will show "KILL" during reset. The device is reset to its default settings, i.e. all stored data are lost!</p> <p>This includes all operating parameters, limits and extreme values as well as the off-delay of the signaling relays. The memory for limit violations is deleted.</p> <p>The settings for time, date, language and bus communication are not affected by a reset.</p> <p>Check all operating parameters for correctness!</p>
--	--

12.2 Delete energy meter

12.2.1 Delete energy meter manually

Hold the  button for about 4 seconds to delete the continuous energy meter value currently displayed (active or reactive energy, HT or LT, consumption or recovery).

12.2.2 Delete all energy meters



To delete all energy meters, you can either reset the device or use the optionally available software and KBR eBus.

12.3 Deleting extreme values

12.3.1 Deleting individual extreme values

Press the button  for approximately 4 seconds to delete the extreme values (minimum or maximum values) currently displayed.

12.3.2 Deleting all extreme values

To delete all minimum and maximum values, hold the buttons  and  for about 4 seconds while any minimum or maximum value is displayed. The function is also available via the KBR eBus.



12.4 Deleting limit settings

12.4.1 Deleting individual limit settings

You can only deactivate individual limits in programming mode.

In programming mode, set the type of the limit you want to deactivate to "OFF".

12.4.2 Deleting all limit settings

To delete all limits, hold the buttons  and  for about 4 seconds while any limit is displayed. The function is also available via the KBR eBus.

13 Memory functions

13.1 Device settings

All device settings and configuration data for the memory function are stored in the device.

13.2 Basic device parameters

Parameter	Stored by user
Measuring voltage	can be programmed by user in the range from 0001 V to 999.9 kV
Measuring voltage, secondary	can be programmed by user in the range from 0001 V to 600V
Measuring current; transformer primary current	can be programmed by user in the range from 0001 A to 999.9 kA
Measuring current (at the input side, i.e. secondary transformer!)	can be selected by user: 1A or 5A
Average current value	Period duration of the average value calculation
Transformer ratio neutral conductor current primary/secondary	Primary can be programmed in the range from 0001 V ... 999.9 kV Secondary can be selected by user: 1 A or 5 A
Neutral conductor current	measured (inp.) or calculated (calc)
Pulse output type / pulse significance / pulse length	acc. to user settings
Tariff switching	the user can select digital input, switching via eBus or switching at times programmed in the device
Synchronization settings	Setting options see measurement period synchronization
Bus address	acc. to user settings between 0001 and 9999
Time	acc. to user settings in hh:mm:ss
Password	according to user settings password is a 4-digit number (leading zeros) 9999 means: Device is not password-protected
Device name	any name chosen by the user*
Event name	an individual designation is assigned to every event

Continued

Measurement period	1/15/30/60 min*
	can be set by user to 0-10 V, 2-10 V, 0-20 mA or 4-20 mA

* This function can only be set using the computer, with optionally available software.

13.3 Load profile memory

The measuring device has a load profile memory that can record a maximum of up to 35136 entries depending on the number of parameters to be stored (active power periods for HT and LT, consumption and recovery, reactive power periods for HT and LT, capacitive and inductive) and the measurement period selected by the user (period values of 60/30/15/1 minute(s) are possible). This means that a period of 15 minutes results in a maximum storage duration of 366 days.

The measurement period and the selection of the parameters to be saved can be parameterized using a computer with the optionally available software.



NOTE

Setting the internal clock:

If the time of the multimes F144-2-LED-...-5 is set to less than the duration of one period, the measurement for the instantaneous period is finished and saved the next time the device synchronizes.

If the time of the multimes F144-2-LED-...-5 is adjusted by more than the period time, the load profile memory is deleted and restarted.

In both cases, a clock adjustment event is created and saved in the event memory/operation logbook. Adjusting the period time:

If the period time is adjusted, the load profile memory is deleted and restarted.

An adjustment event (adjustment of the parameters) is created and entered in the event memory/operation logbook.

13.4 Annual energy memory

The daily energy values of the past 366 days for WAct consumption, WAct recovery, WReact inductive and WReact capacitive are stored separately for high and low tariff in an annual energy memory.

13.5 Event memory/operation logbook

The event memory/operation logbook saves 4096 events with date, time and status in a ring buffer. The following events are acquired:

Event	Recording
Tariff input	Switchover signal HT => LT with date and time Switchover signal LT => HT with date and time
Sync input	Subsequent synchronization with date and time, information on the synchronization type
Power failures	with date, time and duration of the power failure
Error	Error type with date and time
Changed settings/deletions (powerfail entry)	e.g. reset via KBR eBUS/set clock/deletions / parameter changes leading to deletions
Measuring voltage failures	If the power is reduced to 85% of the rated voltage for longer than 20 ms (can be set using the computer).



NOTE

The described memories can only be read out or configured via the KBR - eBus by means of optionally available software.

13.6 Measurement period synchronization

The measurement period of the multimes F144-2-LED-...-5 can be synchronized in four ways, with the measurement period being adjustable. The measurement period and the synchronization always affect all period significance values.

The following 4 types of synchronization are possible.

13.7 Synchronization only by internal clock

Synchronization by internal clock is started with the factory reset.

**NOTE**

The described memories can only be read out or configured via the KBR eBus by means of optionally available software.

13.8 Synchronization by the energy supplier's synchronous pulse

If the synchronous pulse is available as floating contact from the energy supplier, it can be connected to the synchronization input. If the contact closes for at least 250 ms, it is detected as a synchronous pulse and the measurement period is restarted.

Under certain operating conditions, the energy supplier may carry out a subsequent synchronization while a measurement period is still running. The multimes F144-2-LED-...-5 ends the current period measurement and saves the period value with a timestamp. The time pattern is shifted to the new start time and a new measurement is started immediately.

Example:

The period time is set to 15 minutes, i.e. 20 kW input power results in a period value of 20 kW (15 min period). If an intermediate synchronization is performed 3 minutes after period and this 3-minute period is saved, the period value to be recorded is 4 kW.

If the energy supplier's synchronous pulse is not available, the status message "ext. synchronous pulse missing" is issued and the internal clock continues the time frame.

13.9 Synchronization by KBR eBus

Synchronization is carried out via a telex created either by the computer or the bus master and sent to the selected recipients via the KBR eBUS .

Under certain operating conditions, a subsequent synchronization may be carried out while a measurement period is still running. The multimes F144-2-LED-...-5 ends the current period measurement and saves the period value with a timestamp. The time pattern is shifted to the new start time and a new measurement is started immediately.

Example:

The period time is set to 15 minutes, i.e. 20 kW input power results in a period value of 20 kW (15 min period).

If an intermediate synchronization is performed 3 minutes after period start and this 3-minute period is saved, the period value to be recorded is 4 kW.

If the KBR eBUS synchronous pulse is not available, the status message "ext. synchronous pulse missing" is issued and the internal clock continues the time frame.

13.10 Synchronization at tariff change

This type of synchronization makes it possible for the measuring device to change tariffs immediately after the tariff HT/LT has been switched instead of waiting until the end of the measurement period.

The internal clock synchronizes the measurement period. Depending on the configuration by contact at the HT/LT input or by bus signal, this event will also synchronize the measurement period if the tariff is changed. Under certain operating conditions, the synchronization pulse and the internal measurement period synchronization may not be in accordance with the same time pattern. The multimes F144-2-LED-...-5 ends the current period measurement and saves the period value with a timestamp. The time pattern is shifted to the new start time and a new measurement is started immediately.

Example:

The period time is set to 15 minutes, i.e. 20 kW input power results in a period value of 20 kW (15 min period). If a synchronization is performed 3 minutes after period start and this 3 minute period is saved, the period value to be recorded is 4 kW.

14 Technical data

14.1 Measuring and display values

Wave form for U and I		any
Voltage	RMS value of a measuring interval	Phase - N: $U_{L1-N}; U_{L2-N}; U_{L3-N}$ / phase - phase: $U_{L1-2}; U_{L2-3}; U_{L3-1}$
	Units	[V, kV]; display switches automatically
	Measuring period memory	0.00V to 999.9kV
Current (apparent current)	RMS value of a measuring interval	$I_{L1\ act}; I_{L2\ act}; I_{L3\ act}$; instantaneous value for each phase
	Average value determination	$I_{L1\ avg}; I_{L2\ avg}; I_{L3\ avg}$; floating average value of RMS values over a set period of time
	Units	[A;kA;MA]; display switches automatically
	Measuring period memory	0.00A to 999kA
Neutral conductor current	RMS value of a measuring interval	$I_{N\ act}/I_{N\ avg}$ Instantaneous and average value - cf. "Phase current"
	Units	[A;kA;MA]; display switches automatically
	Measuring period memory	0.00A to 999kA
Frequency	Power frequency measurement	f_{Net} ; measured with mains tracking, either 50 Hz fixed or 60 Hz fixed
	Units	[Hz]
	Measuring period memory	45 - 65 Hz
Apparent power	Calculation	$S_{L1}; S_{L2}; S_{L3}; S_{tot}$
	Units	[VA; kVA; MVA] display switches automatically
	Measuring period memory	0.00VA to 999MVA
Active power	Calculation	$P_{L1}; P_{L2}; P_{L3}; P_{total}$
	Units	[W; kW; MW] display switches automatically
	Measuring period memory	0.00W to 999MW
Reactive power	Calculation ind. & cap.	$Q_{L1}; Q_{L2}; Q_{L3}; Q_{total}$; distinction between ind./cap.
	Units	[var; kvar; Mvar]; display switches automatically.
	Measuring period memory	0.00Var to 999Mvar

Continued overleaf

Continued

Power factor	Calculation ind. & cap.	$\cos_{\phi L1}; \cos_{\phi L2}; \cos_{\phi L3}; PF_{L1}; PF_{L2}; PF_{L3}; PF_{Tot};$ distinction between ind./cap. \cos_{ϕ} on the display
	Measuring period memory	CosPhi 0.1 ind. - 1 - 0,1 cap., LF 0,1 - 1
Active energy	Calculation	W(HT/LT)
	Units	[Wh; kWh; MWh; GWh]; display switches automatically
	Measuring period memory	0.0 Wh to 9999 GWh
Reactive energy	Calculation	W_{React} (HT/LT) \rightarrow ind. or cap.
	Units	[varh; kvarh; Mvarh; Gvarh]; display switches automatically
	Measuring period memory	0.0 varh to 9999 Gvarh
Harmonics	Distortion factor (THD) for voltage	Voltage: DF- U_{L1} ; DF- U_{L2} ; DF- U_{L3} ;
	Partial distortion factors	3 rd ; 5 th ; 7 th ; 9 th ; 11 th ; 13 th ; 15 th ; 17 th to 63 rd harmonic of the voltage separated for each phase
	Units	[%]
	Measuring period memory	0.00% to 100%
Current harmonics	Current harmonics, Current harmonics total	3 rd ; 5 th ; 7 th ; 9 th ; 11 th ; 13 th ; 15 th ; 17 th to 63 rd harmonic of the current separated for each phase $I_{SumL1}; I_{SumL2}; I_{SumL3}$
	Units	[A; kA] display is switched automatically
	Measuring period memory	0.00A to 999.9kA

14.2 Measurement accuracy class (in accordance with DIN EN 61557-12)

Measured value	Symbol	Accuracy class
Voltage	U_{PHN}	0.2 / ± 1 digit
Voltage	U_{PPPH}	0.2 / ± 1 digit
Phase current	I	0.5 / ± 1 digit
Neutral conductor current measured	I_N	0.5 / ± 1 digit
Neutral conductor current calculated	I_{Nc}	2 / ± 1 digit
Power factor	PF_A	1 / ± 1 digit
CosPhi of the fundamental components		1 / ± 1 digit
Frequency	f	0.02 / ± 1 digit
Total apparent power	S_A	1 / ± 1 digit
Total active power	P	1 / ± 1 digit
Total reactive power	E_a	1 / ± 1 digit
Total reactive power fundamental components	Q_a	1 / ± 1 digit
Total reactive energy consumption and recovery	Q_a	1 / ± 1 digit
Voltage harmonics	U_h	1 / ± 1 digit
THD of the voltage	THD- R_u	1 / ± 1 digit
Current harmonics	I_h	1 / ± 1 digit

14.3 Measuring principle

Sampling	205 measuring points per period (50 Hz) 170 measuring points per period (60 Hz)
A/D converter	16 bit
Measurement of V and I	Simultaneous recording of V and I readings;
Harmonics calculation	FFT with 2048 points over 10 periods (50 Hz) FFT with 2048 points over 12 periods (60 Hz)
Frequency measurement	Consumption: Voltage measurement between phases L1, L2, L3 - N; correct frequency measurement with power supply correction

24315_EDBDA0264-1419-1_EN

14.4 Device memory

Energy, data and parameter memory		2 MB Flash
Program memory		512 kB flash
Memory type		Ring buffer
Long-term memory (1 year)		Daily values for active and reactive energy (HT and LT) for consumption and recovery
Long-term memory (load profile) for 1464/732/366/24 days		60/30/15/1 minute - values of: Active energy, reactive energy (each consumption and recovery)
Extreme values (max./min.)		Extrem values that occurred after connecting the unit to the power supply or after the outlier memory was deleted manually (maximum indicator function) including date and time
Event memory	Memory size	1500 events including date and time of their occurrence
Operation logbook	Memory size	500 events including date and time of their occurrence
Limit violation	Time for acquisition	≥ 200 ms
Voltage dips of the measuring voltage	Time for acquisition	≥ 20 ms; threshold can be set using the computer, value after reset 85% of rated voltage (in accordance with EN 61000-4-30).

14.5 Power supply

Power consumption <18VA, 10 W	US1: ≈ 100 - 240 V ±10% DC/50/60 Hz
Power consumption <15 VA, 10 W	US5: ≈ 22.5 - 64 V ±10% DC/50/60 Hz

14.6 Hardware inputs and outputs

14.6.1 Inputs

Voltage measuring inputs	$U_{L1-L2}; U_{L2-L3}; U_{L3-L1}$	3 x 5 V - 100 V - 120 V AC (measuring range 1) 3 x 20 V - 500 V - 600 V AC (measuring range 2)
	Input impedance	1.2 MOHM (Ph-Ph)
	Measuring period memory	can be configured using voltage and current transformers
Current measurement inputs	$I_{L1}; I_{L2}; I_{L3}; I_N$	4 x 0.01 A - 1 A - 1.2 A AC (measuring range 1) 4 x 0.05 A - 5 A - 6 A AC (measuring range 2)
	Power consumption	≤ 0.3 VA per input at 6 A
	Measuring period memory	can be configured using voltage and current transformers
Digital inputs	Rate input	Digital input for floating contact, HT/LT switching, signal e.g. from energy supplier, contact open => HT, contact closed => LT
	Synchronous input	Digital input for floating contact Measurement period synchronization; pulse length ≥ 250 ms
	Power supply	27 V/15 mA DC internal

14.6.2 Outputs

Signal relay for	Number	2
	Contact	floating, open in case of limit violation
limit violations	Reaction speed	programmable, max. 254 sec.
	Switching capacity	Max. 250 V (AC)/2 A floating - not safe to touch. Both relays must be in the same phase.
Pulse output	Output type	Proportional to active or reactive energy, configurable on the device from 0.001 to 9990 pulse(s) per kWh
	Optocoupler output	15 mA at max. 35 V; interface S ₀ -compatible
	Accuracy class	2
	Pulse length	configurable, min. 30 ms, max. 990 ms
	Power supply	external

Continued overleaf

Continued

	Number	3, common negative pole
	Load capacity	Max. 20 mA at current output (max. resistance 500 ohms) Max. 10 V at voltage output (min. resistance 1000 ohms)
	Signal	Can be set to 0-10V, 2-10V or 0-20mA, 4-20mA
Serial interface	BUS	RS485 for connection to the KBR eBus or Modbus; max. 32 devices, up to 1000 devices with bus repeater
	Baud rate	38400 fixed at KBR eBus, configurable with Modbus
	Addressing	For KBR-eBus: can be addressed automatically with software or manually on the device up to address 9999 For Modbus: Adr. 1 to 247 manually on the device.

14.7 Electrical connection

Connection elements		Plug-in terminals
Permissible cross-section of the connecting cables		2.5 mm ²
Measurement voltage inputs	Fuse protection	max. 1 A slow-blow max. C2 automatic isolating switch UL/IEC-approved
Measurement current inputs	Fuse protection	NONE!!! Always short-circuit current transformer terminals k and l before opening the circuit!
Input control voltage	Fuse protection	max. 1 A slow-blow max. C2 automatic isolating switch UL/IEC-approved
Relay output	Fuse protection	max 2A medium time-lag
BUS connection	Connection material	To ensure proper operation, only use shielded twisted-pair cables; e.g. I-Y-St-Y2x2x0.8 EIB
Pulse output	Connection and cables	Observe correct polarity! To ensure proper operation, only use shielded twisted-pair cables; e.g. I-Y-St-Y2x2x0.8 EIB

Continued

Transformer connection	Connections	See wiring diagram
Analog output	Connections	Ensure correct polarity!
Interface connection	RS485 BUS connector pins	Terminal 90 (L) Terminal 91 (A) Terminal 92 (B)

14.8 Mechanical data

Switchboard installation	Housing dimensions	144 x 144 x 60 mm (H x W x D)
	Installation cut-out	138 x 138 mm
	Weight	700 g

24315_EDEBD0264-1419-1_EN

14.9 Ambient conditions, electrical safety and standards

Ambient conditions	Standards	DIN EN 60721-3-3:1995-09 + DIN EN 60721-3-3/A2:1997-07; 3K5+3Z11; (IEC721-3-3;3K5+3Z11)	
	Operating temperature	K55 (-5 °C - +55 °C)	
	Humidity	5% - 95% non-condensing	
	Storage temperature	K55 (-25 °C ... +70 °C)	
	Operating altitude	0 to 2000 m above sea level	
Electrical safety	Standards	DIN EN 61010-1:2011-07; DIN EN 61010-2-030:2011-07	
	Protection category	I	
	Oversvoltage category, measurement category	Voltage measurement: Current measurement: Power supply:	CAT III: 300 V; CAT II: 400 V CAT III: 300V CAT III: 300V
	Rated surge voltage	4kV	
Protection type	Standards	DIN EN 60529:2014-09	
	Front	IP 40, with IP 51 seal	
	Terminals	IP 20	
EMC	Standards	DIN EN 61000-6-2:2006-03 + amendment 1:2011-03 DIN EN 611326-1:2013-07 Devices without Profibus DP DIN EN 61000-6-3:2011-09 + amendment 1:2012-11 Devices with Profibus DP DIN EN 61000-6-4:2011-09	
Synchronization	Type	internal, manual, rate switching or by KBR eBus	
Synchronization time		With internal synchronization based on the full hour	

15 Serial interface

15.1 RS 485 bus operation

The RS485 port of the multimes F144-2-LED-...-5 is designed for operation at the KBR eBus. With the KBR eBus, you can operate one or several multimes F144-2-LED-...-5 devices across great distances. The bus is connected to the computer via the RS485 interface converter. Using the relevant Windows® software, all bus devices can be configured and visualized. Please contact us to obtain information on which other devices you can connect to the KBR eBus and on the functions of our Windows® software.

You can find more information on the structure and technical parameters of the RS 485 bus operation in our KBR eBus installation guide. You are welcome to request this installation guide from us at any time.

16 Overvoltage and lightning protection

To protect your purchased high-quality devices from damage, we strongly recommend that you take overvoltage protection measures. Protect control voltage inputs, pulse and bus lines.

17 Troubleshooting

No function.

Check the power supply, back-up fuse, isolating switch and supply line.

The measuring voltage of a phase is 0V.

Check the back-up fuse and isolating switch of the phase.

A phase of the current display has a different sign.

Check k and l of current measurement and correct if necessary.

Compared to the measurement of the energy supplier, the measured values for energy and power are too small.

Check k and l of the current measurement as well as if the phases of the transformers are correct and adjust if required.

An LED flashes.

There has been a limit violation in the menu that corresponds to the flashing LED.

Description of sensor buttons and displays in **8**, Chapter 7.1.

ErrU OVERLOAD or ErrI OVERLOAD.

ErrU: Voltage input of the measuring amplifier overloaded
Switch off measuring voltage and check set transformer ratio. In case of direct measurement, the programmed secondary voltage value must correspond to the mains voltage.

Note: The device chooses the measuring range depending on the programmed secondary voltage. MULTIMESS F144-2-LED-...-5 works in the measuring range 1 if the programmed value of the secondary voltage does not exceed 120V. If it does, multimes F144-2-LED-...-5 operates in measuring range 2.

Measuring range 1: 5V to 120V AC, measuring range 2: 20V to 600V AC.

ErrI: Current input of the measuring amplifier overloaded
Adjust programming and select larger measuring range. Alternatively, switch off the measuring current and check the transformer ratio.

Note: The device selects the measuring range depending on the secondary current that was set, i.e. either measuring range 1 at 1 A or measuring range 2 at 5 A.

18 Appendix







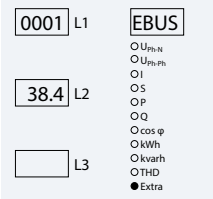

18.1 Added functionality: Profibus

The multimes F144 -2-ESMS -...- 5 is available with the Profibus option

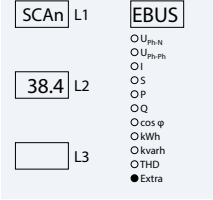
The additional functions are described in this appendix (Configuring Profibus).



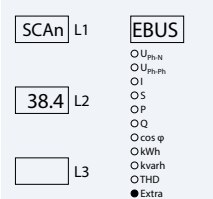



The Profibus bus protocol is only available if the device is equipped with a Profibus interface.

18.2 Setting the bus protocol

Menu	Button(s)	Device display	Description
Main menu Extra			
eBus submenu	 Start input mode (eBus Scan)		Display L1 shows the device address. The baud rate is displayed on Display L2. The unit display shows the current bus protocol (e.g. eBus)
Assign eBus submenu address	 Start input mode		Display L1 shows SCAN, i.e. the scan address has been set. Press the  button to enter the input mode for setting the bus address.
Change eBus submenu protocol	 To the change bus protocol  Changing the bus protocol		The first digit on Display L1 flashes. Press the  button to go to the bus protocol display (bus protocol display flashes). The  button can be used to change the bus protocol, e.g. from KBR eBus to Profibus

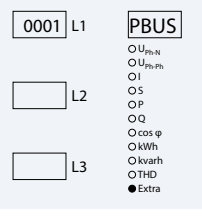
Continued on the right

Continued

Menu	Button(s)	Device display	Description
eBus submenu Save bus protocol	 Cancel or  Save		The unit display shows the selected bus protocol. The bus address is displayed on Display L1.
 NOTE	 	Return to main menu Continue to the next submenu, if available, or return to the main menu.	

**NOTE**

Change the bus address with the  button (input), select the segment with the  button, change the address with the  button, press  to save.

Appendix:

Profibus Protocol description Option Profibus

Table of contents

1	General.....	2
2	Data formats.....	2
3	GSD file.....	6
4	Output data.....	12
5	Input data.....	13
6	Example for integration into a Simatic S7-300 control.....	28

1 General

The present internal Profibus interface enables the readout of the following KBR devices by Profibus:

- multimes Basic
- multimes Comfort
- multinet Basic
- multinet Comfort
- multimes 4F96
- multimes F96-...-5
- multimes F144-...-5

2 Data formats

(unsigned) short: 0x1234

Address	+0	+1
Contents	0x12	0x34

Rule for byte sequence:
MSB before LSB

(unsigned) long: 0x12345678

Address	+0	+1	+2	+3
Contents	0x12	0x34	0x56	0x78

Rule for byte sequence:
MSB before LSB

float:

Format	Complies with the IEEE 754 standard
Representation	4 bytes
Accuracy	24 bits (> represent >7 decimal points)
Composition	24-bit mantissa, 8-bit exponent
Mantissa	23 bits (M) + 1 bit (S) The MSB of the mantissa is always 1 => it is not saved separately! S = sign of the mantissa: S = 1 > negative number; S = 0 > positive number
Exponent	8 bits (0-255); is saved relatively to 127, i.e. the current value of the exponent is calculated by subtracting the number 127 from the saved value. Curr. exp. = saved exp value. — 127 => range of numbers from 128 to -127! Number range which can be represented: 1.18E-38 to 3.40E+38

Example 1: -12.5 decimal = 0xC1480000 hex

M: 24 bit-mantissa

E: Exponent with offset of 127

S: Sign for mantissa (S=1 neg.; S=0 pos.)

Address	+0	+1	+2	+3
Format	SEEEEEEE	EMMMMMMM	MMMMMMMM	MMMMMMMM
Binary	1 1 0 0 0 0 0 1	0 1 0 0 1 0 0 0	0 0 0 0 0 0 0 0	0 0 0 0 0 0 0 0
Hex	C1	48	00	00

The byte sequence is defined as follows:

The byte with the "S sign bit" is transmitted over the bus as the first byte.

The sequence of the float bytes of the bus can be reversed, where required, using the "commands" module (see table 1).

The following information can be derived from this:

The sign bit is 1 => negative mantissa

The value of the exponent amounts to 10000010 bin or 130 dec.

This results in an exponent value of: $130 - 127 = 3$

The mantissa has the following value: 1001000000000000000000

The decimal point can be found at the left end of the mantissa, preceded by a 1. This position does not appear in the hexadecimal numeric notation. If you add 1 and set the decimal point at the beginning of the mantissa, the following value is obtained:

1.1001000000000000000000

Now, the mantissa needs to be adjusted to the exponent. A negative exponent shifts the decimal point to the left, a positive exponent shifts it to the right. Since the exponent is 3, this is represented as:

1100.10000000000000000000

The number obtained corresponds to the binary floating-point number.

Binary digits to the left of the decimal point result in values > 1 . In this example, 1100 bin results in the number 12 dec. $\{(1 \times 2^3) + (1 \times 2^2) + (0 \times 2^1) + (0 \times 2^0)\}$

Binary digits to the right of the decimal point result in values < 1 . In this example, .100..... bin results in the number 0.5 dec. $\{(1 \times 2^{-1}) + (0 \times 2^{-2}) + (0 \times 2^{-3}) + (0 \times 2^{-4})\}$

By adding the individual values, 12.5 is obtained. As the sign bit was set, it is a negative value, -12.5. The hexadecimal number 0xC1480000 thus corresponds to -12.5.

Example 2: -12.55155 decimal = 0xC148D325 hex

Address	+0	+1	+2	+3
Format	SEEEEEEE	EMMMMMMM	MMMMMMMM	MMMMMMMM
Binary	1 1 0 0 0 0 0 1	0 1 0 0 1 0 0 0	1 1 0 1 0 0 1 1	0 0 1 0 0 1 0 1
Hex	C1	48	D3	25

Example 3: 45.354 decimal = 0x42356A7F hex

Address	+0	+1	+2	+3
Format	SEEEEEEE	EMMMMMMM	MMMMMMMM	MMMMMMMM
Binary	0 1 0 0 0 0 1 0	0 0 1 1 0 1 0 1	0 1 1 0 1 0 1 0	0 1 1 1 1 1 1 1
Hex	42	35	6A	7F

Exponent: 10000100 bin = 132 dec.

➤ Exp. = 132-127=5

Mantissa: S=0

➤ Sign=positive

011010101101010011111111 bin

Decimal point added to the first position of the mantissa

➤ . 011010101101010011111111

Leading 1 in front of decimal point

➤ 1. 011010101101010011111111

Taking exponent into account (=5)

➤ 101101. 01011010100111111111

To the left of the decimal point: 101101 bin = $2^5 + 2^3 + 2^2 + 2^0 = 45$ dec.

To the right of the decimal point: 01011010100111111111 bin =

$2^{-2} + 2^{-4} + 2^{-5} + 2^{-7} + 2^{-9} + 2^{-12} + 2^{-13} + 2^{-14} + 2^{-15} + 2^{-16} + 2^{-17} + 2^{-18} = 0.3540001$ dez

Final result: +45.3540001 dec.

double:

Format	Complies with the IEEE 754 standard
Representation	8 bytes
Accuracy	52 bits (> represent >15 decimal points)
Composition	52-bit mantissa; 11-bit exponent
Mantissa	52 bits (M) + 1 bit (S) The MSB of the mantissa is always 1 => it is not saved separately! S = sign of the mantissa: S = 1 ➤ negative number; S = 0 ➤ positive number
Exponent	11 bit (0-2047); is saved relative to 1023, i.e. the current value of the exponent is calculated by subtracting the number 1023 from the saved value. Number range which can be represented: 2.23E-308 to 1.80E+308}

Example:

45.354 decimal = 0x4046AD4FDF3B645A hex

M: 52 bit-mantissa

E: Exponent with offset of 1023

S: Sign for mantissa (S=1 neg.; S=0 pos.)

Address	+0	+1	+2	+3
Format	SEEEEEEE	EEEEMMMM	MMMMMMMM	MMMMMMMM
Binary	0 1 0 0 0 0 0 0	0 1 0 0 0 1 1 0	1 0 1 0 1 1 0 1	0 1 0 0 1 1 1 1
Hex	40	46	AD	4F

Address	+4	+5	+6	+7
Format	MMMMMMMM	MMMMMMMM	MMMMMMMM	MMMMMMMM
Binary	1 1 0 1 1 1 1 1	0 0 1 1 1 0 1 1	0 1 1 0 0 1 0 0	0 1 0 1 1 0 1 0
Hex	DF	3B	64	5A

Exponent: 10000000100 bin = 1028 dec.

➤ Exp. = 1028-1023=5

Mantissa: S=0

➤ Sign is positive

01101011010011111101111001110110110010001011010 bin

Decimal point added to the first position of the mantissa

➤ . 0110101101010011111101111001110110110010001011010

Leading 1 in front of decimal point

➤ 1. 01101011010100100111111001110110110010001011010

Taking exponent into account (=5)

➤ 1 01101.0101101010011111101111001110110110010001011010

to the left of the decimal point: 101101 bin = $2^5 + 2^3 + 2^2 + 2^0 = 45$ dec.

To the right of the decimal point:

0101101001111101111001110110110010001011010 bin =

$2^{-2} + 2^{-4} + 2^{-5} + 2^{-7} + 2^{-9} + 2^{-12} + 2^{-13} + 2^{-14} + 2^{-15} + 2^{-16} + 2^{-17} + 2^{-19} +$

$2^{-20} + 2^{-21} + 2^{-22} + 2^{-23} + 2^{-26} + 2^{-27} + 2^{-28} + 2^{-30} + 2^{-31} + 2^{-33} + 2^{-34} + 2^{-37} +$

$2^{-41} + 2^{-43} + 2^{-44} + 2^{-46} = 0.35400000000000$ dec

Final result: +45. 35400000000000 dec.

The byte sequence is defined as follows:

The byte with the "S sign bit" is transmitted over the bus as the first byte.

The sequence of the double bytes of the bus can be reversed, where required, using the "commands" module (see table 1).

Timestamp time_t (is transmitted as unsigned long)

The timestamp describes a point in time. The value is defined as follows:

Seconds since 1/1/1970 0^{oo} hours (with respect to the corresponding time zone)

The values are transmitted over the bus as unsigned long (for byte sequence, see above). All values are to be interpreted as standard time (winter time), i.e. if you want to set the device clock in Germany to 11 o'clock in May, then the setting command via the bus must be done, by definition, with winter time 10 o'clock.

The following applies:

All timestamps which are transmitted via the bus are to be interpreted as standard time (winter time).

The device itself must be parametrized according to country-specific parameters.

Possible settings here:

e.g. in Germany -> daylight saving time from end of March to end of October

e.g. China -> daylight saving time not activated

3 GSD file

The functionality of the device is described by the GSD file. Profimess 3 is a modular device. By lining up the desired modules using the configuration data, the input and output data can be put together any way you like. The offset for the respective values in the input data is derived from the length of the data formats specified in each case.

```

;-----;
; GSD Profimess 3 network measuring device for PROFIBUS DP          ;
; Fa. KBR GmbH, Am Kieferschlag 7 , 91126 Schwabach              ;
; Tel.: 0049 (0) 9122/6373-0                                     ;
; As of: 4/14/2010                                              ;
;-----;

#Profibus_DP
; <Prm-Text-Def-List>
PrmText=1
Text(0)= "do not rotate float/REAL"
Text(1)= "rotate float/REAL"
EndPrmText
; <Ext-User-Prm-Data-Def-List>
ExtUserPrmData=1 "float/REAL byte rotation"
Bit(0) 0-1
Prm_Text_Ref=1
EndExtUserPrmData
;

GSD_Revision      = 2

Vendor_Name       = "KBR GmbH, Schwabach" ; company name
Model_Name        = "PROFIMESS 3"         ; device name
Revision          = "1.0"                 ; device release
Ident_Number      = 0x08C4                ; Ident number
Protocol_Ident    = 0                    ; PROFIBUS_DP Record
Station_Type      = 0                    ; slave station

Hardware_Release  = "V1.0"                ;
Software_Release  = "V1.00"               ;

9.6_supp          = 1                    ; Baud rate 9.6kB supported
19.2_supp         = 1                    ; Baudrate 19.2kB supported
45.45_supp        = 1                    ; Baud rate 45.45kB supported (4/14/10 W.M. added)
93.75_supp        = 1                    ; Baudrate 93.75kB supported
187.5_supp        = 1                    ; Baudrate 187.5kB supported
500_supp          = 1                    ; Baud rate 500kB supported
1.5M_supp         = 1                    ; Baud rate 1.5MB supported
3M_supp          = 1                    ; Baud rate 3MB supported
6M_supp          = 1                    ; Baud rate 6MB supported
12M_supp         = 1                    ; Baud rate 12 MB supported

MaxTsdrr_9.6     = 60
MaxTsdrr_19.2   = 60
MaxTsdrr_45.45  = 60                    ; (4/14/10 W.M. added)
MaxTsdrr_93.75  = 60
MaxTsdrr_187.5  = 60
MaxTsdrr_500    = 100
MaxTsdrr_1.5M   = 150
MaxTsdrr_3M     = 250
MaxTsdrr_6M     = 450
MaxTsdrr_12M    = 800

Freeze_Mode_supp = 0                    ; no Freeze Mode
Sync_Mode_supp   = 0                    ; no Sync Mode
Auto_Baud_supp   = 1                    ; automatic baud rate
Set_Slave_Add_supp = 0                  ; no addressing over BUS
Min_Slave_Interval = 6                  ; min. slave-poll-cycle
Modular_Station  = 1                    ; modular concept
Redundancy       = 0
Repeater_Ctrl_Sig = 0

```

```

24V_Pins      = 0

Max_Diag_Data_Len = 30      ;
Max_Module      = 51      ; 3 bytes Output + 37 4-byte modules + 11 8-byte modules
Slave_Family    = 0
Max_Data_Len    = 247
Max_Input_Len   = 244
Max_Output_Len  = 3

;
; <Parameter-Definition-List>
; User_Prm_Data_Len = 4
; User_Prm_Data = 0x00,0x00,0x00,0x00
Max_User_Prm_Data_Len = 4
Ext_User_Prm_Data_Ref(3)=1

Module="device status (read and reset)"  0x91,0xA0 ; reset status with <> 0 in Outputdata
EndModule
Module="clear-commands"  0xA0 ; Bit0: reset extreme values (maxima)
; Bit1: reset extreme values (minima)
; Bit2: reset endless active work counter HT/LT consumption
; Bit3: reset endless reactive work counter HT/LT consumption
; Bit4: reset endless active work counter HT/LT supply (only comfort devices)
; Bit5: reset endless reactive work counter HT/LT supply (only comfort devices)
; Bit6: reset daily work counters
; Bit7: reserved

EndModule
Module="switch-commands"  0x20 ; Bit0: switch to HT (bit must go from 0 to 1)
; Bit1: switch to LT (bit must go from 0 to 1)
; Bit2: switch to reverse float byte order (bit must go from 0 to 1)
; Bit3: switch to standard float byte order (bit must go from 0 to 1)
; Bit4:
; Bit5:
; Bit6:
; Bit7:

EndModule
; 0123456789abcdef0123456789ABCDEF" Unit Format Size
Module="voltage PH-N L1-L3" 0x41,0x8B, 1 ; V float 12
EndModule
Module="voltage PH-PH L1-L3" 0x41,0x8B, 2 ; V float 12
EndModule
Module="current L1-L3" 0x41,0x8B, 3 ; A float 12
EndModule
Module="current average. L1-L3" 0x41,0x8B, 4 ; A float 12
EndModule
Module="apparent power L1-L3" 0x41,0x8B, 5 ; VA float 12
EndModule
Module="active power L1-L3" 0x41,0x8B, 6 ; W float 12
EndModule
Module="reactive power L1-L3" 0x41,0x8B, 7 ; var float 12
EndModule
Module="cos Phi L1-L3" 0x41,0x8B, 8 ; - float 12
EndModule
Module="powerfactor L1-L3" 0x41,0x8B, 9 ; - float 12
EndModule
Module="THD voltage L1-L3" 0x41,0x8B, 10 ; % float 12
EndModule
Module="voltage 3rd harmonic L1-L3" 0x41,0x8B, 11 ; % float 12
EndModule
Module="voltage 5th harmonic L1-L3" 0x41,0x8B, 12 ; % float 12
EndModule
Module="voltage 7th harmonic L1-L3" 0x41.0x8B, 13 ; % float 12
EndModule
Module="voltage 9th harmonic L1-L3" 0x41.0x8B, 14 ; % float 12
EndModule
Module="voltage 11th harmonic L1-L3" 0x41.0x8B, 15 ; % float 12
EndModule
Module="voltage 13th harmonic L1-L3" 0x41.0x8B, 16 ; % float 12
EndModule
Module="voltage 15th harmonic L1-L3" 0x41.0x8B, 17 ; % float 12
EndModule
Module="voltage 17th harmonic L1-L3" 0x41.0x8B, 18 ; % float 12
EndModule
Module="voltage 19th harmonic L1-L3" 0x41.0x8B, 19 ; % float 12
EndModule
Module="distortion-currentL1-L3" 0x41,0x8B, 20 ; A float 12

```

EndModule					
Module="current 3rd harmonic L1-L3"	0x41,0x8B, 21 ; A	float	12		
EndModule					
Module="current 5th harmonic L1-L3"	0x41,0x8B, 22 ; A	float	12		
EndModule					
Module="current 7th harmonic L1-L3"	0x41,0x8B, 23 ; A	float	12		
EndModule					
Module="current 9th harmonic L1-L3"	0x41,0x8B, 24 ; A	float	12		
EndModule					
Module="current 11th harmonic L1-L3"	0x41,0x8B, 25 ; A	float	12		
EndModule					
Module="current 13th harmonic L1-L3"	0x41,0x8B, 26 ; A	float	12		
EndModule					
Module="current 15th harmonic L1-L3"	0x41.0xx8B, 27 ; A	float	12		
EndModule					
Module="current 17th harmonic L1-L3"	0x41,0x8B, 28 ; A	float	12		
EndModule					
Module="current 19th harmonic L1-L3"	0x41,0x8B, 29 ; A	float	12		
EndModule					
Module="max: voltage PH-N L1-L3"	0x41,0x8B, 30 ; V	float	12		
EndModule					
Module="max: voltage PH-PH L1-L3"	0x41,0x8B, 31 ; V	float	12		
EndModule					
Module="max: current L1-L3"	0x41,0x8B, 32 ; A	Float	12		
EndModule					
Module="max: current average. L1-L3"	0x41,0x8B, 33 ; A	float	12		
EndModule					
Module="max: appearent power L1-L3"	0x41,0x8B, 34 ; VA	float	12		
EndModule					
Module="max: active power L1-L3"	0x41,0x8B, 35 ; W	float	12		
EndModule					
Module="max: reactive power L1-L3"	0x41,0x8B, 36 ; var	float	12		
EndModule					
Module="max: cos Phi L1-L3"	0x41,0x8B, 37 ; -	float	12		
EndModule					
Module="max: powerfactor L1-L3"	0x41,0x8B, 38 ; -	float	12		
EndModule					
Module="max: THD voltage L1-L3"	0x41,0x8B, 39 ; %	float	12		
EndModule					
Module="max: voltage 3rd harmonic L1-L3"	0x41,0x8B, 40 ; %	float	12		
EndModule					
Module="max: voltage 5th harmonic L1-L3"	0x41,0x8B, 41 ; %	float	12		
EndModule					
Module="max: voltage 7th harmonic L1-L3"	0x41,0x8B, 42 ; %	float	12		
EndModule					
Module="max: voltage 9th harmonic L1-L3"	0x41,0x8B, 43 ; %	float	12		
EndModule					
Module="max: voltage 11th harmonic L1-L3"	0x41.0xx8B, 44 ; %	float	12		
EndModule					
Module="max: voltage 13th harmonic L1-L3"	0x41.0xx8B, 45 ; %	float	12		
EndModule					
Module="max: voltage 15th harmonic L1-L3"	0x41.0xx8B, 46 ; %	float	12		
EndModule					
Module="max: voltage 17th harmonic L1-L3"	0x41.0xx8B, 47 ; %	float	12		
EndModule					
Module="max: voltage 19th harmonic L1-L3"	0x41.0xx8B, 48 ; %	float	12		
EndModule					
Module="max: distortion currentL1-L3"	0x41.0xx8B, 49 ; A	float	12		
EndModule					
Module="max: current 3rd harmonic L1-L3"	0x41,0x8B, 50 ; A	float	12		
EndModule					
Module="max: current 5th harmonic L1-L3"	0x41,0x8B, 51 ; A	float	12		
EndModule					
Module="max: current 7th harmonic L1-L3"	0x41,0x8B, 52 ; A	float	12		
EndModule					
Module="max: current 9th harmonic L1-L3"	0x41,0x8B, 53 ; A	float	12		
EndModule					
Module="max: current 11th harmonic L1-L3"	0x41,0x8B, 54 ; A	float	12		
EndModule					
Module="max: current 13th harmonic L1-L3"	0x41.0xx8B,55 ; A	float	12		
EndModule					
Module="max: current 15th harmonic L1-L3"	0x41.0xx8B,56 ; A	float	12		
EndModule					
Module="max: current 17th harmonic L1-L3"	0x41,0x8B, 57 ; A	float	12		
EndModule					
Module="max: current 19th harmonic L1-L3"	0x41.0xx8B,58 ; A	float	12		
EndModule					

Module="min: voltage PH-N L1-L3"	0x41,0x8B, 59 ; V	float	12
EndModule			
Module="min: voltage PH-PH L1-L3"	0x41,0x8B, 60 ; V	float	12
EndModule			
Module="min: current L1-L3"	0x41,0x8B, 61 ; A	float	12
EndModule			
Module="min: current average. L1-L3"	0x41,0x8B, 62 ; A	float	12
EndModule			
Module="min: appearent power L1-L3"	0x41,0x8B, 63 ; VA	float	12
EndModule			
Module="min: active power L1-L3"	0x41,0x8B, 64 ; W	float	12
EndModule			
Module="min: reactive power L1-L3"	0x41,0x8B, 65 ; var	float	12
EndModule			
Module="min: cos Phi L1-L3"	0x41,0x8B, 66 ; -	float	12
EndModule			
Module="min: powerfactor L1-L3"	0x41,0x8B, 67 ; -	float	12
EndModule			
Module="max-date: voltage PH-N L1-L3"	0x41,0x8B, 68 ; -	unsigned long	12
EndModule			
Module="max-date: voltage PH-PH L1-L3"	0x41,0x8B,69 ; -	unsigned long	12
EndModule			
Module="max-date: current L1-L3"	0x41,0x8B, 70 ; -	unsigned long	12
EndModule			
Module="max-date: current average L1-L3"	0x41,0x8B, 71 ; -	unsigned long	12
EndModule			
Module="max-date: appearent power L1-L3"	0x41,0x8B, 72 ; -	unsigned long	12
EndModule			
Module="max-date: active power L1-L3"	0x41,0x8B, 73 ; -	unsigned long	12
EndModule			
Module="max-date: reactive power L1-L3"	0x41,0x8B, 74 ; -	unsigned long	12
EndModule			
Module="max-date: cos Phi L1-L3"	0x41,0x8B, 75 ; -	unsigned long	12
EndModule			
Module="max-date: powerfactor L1-L3"	0x41,0x8B, 76 ; -	unsigned long	12
EndModule			
Module="max-date: THD voltage L1-L3"	0x41,0x8B, 77 ; -	unsigned long	12
EndModule			
Module="max-date: voltage 3rd harmonic L1-L3"	0x41,0x8B, 78 ; -	unsigned long	12
EndModule			
Module="max-date: voltage 5th harmonic L1-L3"	0x41,0x8B, 79 ; -	unsigned long	12
EndModule			
Module="max-date: voltage 7th harmonic L1-L3"	0x41,0x8B, 80 ; -	unsigned long	12
EndModule			
Module="max-date: voltage 9th harmonic L1-L3"	0x41,0x8B, 81 ; -	unsigned long	12
EndModule			
Module="max-date: voltage 11th harmonic L1-L3"	0x41,0x8B, 82 ; -	unsigned long	12
EndModule			
Module="max-date: voltage 13th harmonic L1-L3"	0x41,0x8B, 83 ; -	unsigned long	12
EndModule			
Module="max-date: voltage 15th harmonic L1-L3"	0x41,0x8B, 84 ; -	unsigned long	12
EndModule			
Module="max-date: voltage 17th harmonic L1-L3"	0x41,0x8B, 85 ; -	unsigned long	12
EndModule			
Module="max-date: voltage 19th harmonic L1-L3"	0x41,0x8B, 86 ; -	unsigned long	12
EndModule			
Module="max-date: dist. currentL1-L3"	0x41,0x8B, 87 ; -	unsigned long	12
EndModule			
Module="max-date: current 3rd harmonic L1-L3"	0x41,0x8B, 88 ; -	unsigned long	12
EndModule			
Module="max-date: current 5th harmonic L1-L3"	0x41,0x8B, 89 ; -	unsigned long	12
EndModule			
Module="max-date: current 7th harmonic L1-L3"	0x41,0x8B, 90 ; -	unsigned long	12
EndModule			
Module="max-date: current 9th harmonic L1-L3"	0x41,0x8B, 91 ; -	unsigned long	12
EndModule			
Module="max-date: current 11th harmonic L1-L3"	0x41,0x8B, 92 ; -	unsigned long	12
EndModule			
Module="max-date: current 13th harmonic L1-L3"	0x41,0x8B, 93 ; -	unsigned long	12
EndModule			
Module="max-date: current 15th harmonic L1-L3"	0x41,0x8B, 94 ; -	unsigned long	12
EndModule			
Module="max-date: current 17th harmonic L1-L3"	0x41,0x8B, 95 ; -	unsigned long	12
EndModule			
Module="max-date: current 19th harmonic L1-L3"	0x41,0x8B, 96 ; -	unsigned long	12
EndModule			
Module="min-date: voltage PH-N L1-L3"	0x41,0x8B, 97 ; -	unsigned long	12

EndModule				
Module="min-date: voltage PH-PH L1-L3"	0x41,0x8B, 98 ; -	unsigned long	12	
EndModule				
Module="min-date: current L1-L3"	0x41,0x8B, 99 ; -	unsigned long	12	
EndModule				
Module="min-date: current avg L1-L3"	0x41,0x8B,100 ; -	unsigned long	12	
EndModule				
Module="min-date: appearent power L1-L3"	0x41,0x8B,101 ; -	unsigned long	12	
EndModule				
Module="min-date: active power L1-L3"	0x41,0x8B,102 ; -	unsigned long	12	
EndModule				
Module="min-date: reactive power L1-L3"	0x41,0x8B,103 ; -	unsigned long	12	
EndModule				
Module="min-date: cos Phi L1-L3"	0x41,0x8B,104 ; -	unsigned long	12	
EndModule				
Module="min-date: powerfactor L1-L3"	0x41,0x8B,105 ; -	unsigned long	12	
EndModule				
Module="frequency"	0x41,0x83, 106 ;	Hz float	4	
EndModule				
Module="zero conductor current"	0x41,0x83, 107 ;	A float	4	
EndModule				
Module="average zero conductor current"	0x41,0x83,108 ;	A float	4	
EndModule				
Module="total active power"	0x41,0x83,109 ;	W float	4	
EndModule				
Module="total reactive power"	0x41,0x83,110 ;	var float	4	
EndModule				
Module="total appearent power"	0x41,0x83,111 ;	VA float	4	
EndModule				
Module="powerfactor"	0x41,0x83,112 ; -	float	4	
EndModule				
Module="error status"	0x41,0x83, 113 ; -	unsigned long	4	
EndModule				
Module="time"	0x41,0x83,114 ; -	unsigned long	4	
EndModule				
Module="max: frequency"	0x41,0x83,115 ;	Hz float	4	
EndModule				
Module="max: zero conductor current"	0x41,0x83,116 ;	A float	4	
EndModule				
Module="max: avg zero conductor current"	0x41,0x83,117 ;	A float	4	
EndModule				
Module="max: total active power"	0x41,0x83,118 ;	W float	4	
EndModule				
Module="max: total reactive power"	0x41,0x83,119 ;	var float	4	
EndModule				
Module="max: total appearent power"	0x41,0x83,120 ;	VA float	4	
EndModule				
Module="max: powerfactor"	0x41,0x83,121 ; -	float	4	
EndModule				
Module="min: frequency"	0x41,0x83,122 ;	Hz float	4	
EndModule				
Module="min: zero conductor current"	0x41,0x83,123 ;	A float	4	
EndModule				
Module="min: avg zero conductor current"	0x41,0x83,124 ;	A float	4	
EndModule				
Module="min: total active power"	0x41,0x83,125 ;	W float	4	
EndModule				
Module="min: total reactive power"	0x41,0x83,126 ;	var float	4	
EndModule				
Module="min: total appearent power"	0x41,0x83,127 ;	VA float	4	
EndModule				
Module="min: powerfactor"	0x41,0x83,128 ; -	float	4	
EndModule				
Module="max-date: frequency"	0x41,0x83,129 ; -	unsigned long	4	
EndModule				
Module="max-date: zero cond. current"	0x41,0x83,130 ; -	unsigned long	4	
EndModule				
Module="max-date: avg zero cond.current"	0x41,0x83,131 ; -	unsigned long	4	
EndModule				
Module="max-date: total active power"	0x41,0x83,132 ; -	unsigned long	4	
EndModule				
Module="max-date: total reactive power"	0x41,0x83,133 ; -	unsigned long	4	
EndModule				
Module="max-date: total appearent power"	0x41,0x83,134 ; -	unsigned long	4	
EndModule				
Module="max-date: powerfactor"	0x41,0x83,135 ; -	unsigned long	4	
EndModule				

Module="min-date: frequency"	0x41,0x83,136 ; -	unsigned long	4
EndModule			
Module="min-date: zero cond. current"	0x41,0x83,137 ; -	unsigned long	4
EndModule			
Module="min-date: avg zero cond.current"	0x41,0x83,138 ; -	unsigned long	4
EndModule			
Module="min-date: total active power"	0x41,0x83,139 ; -	unsigned long	4
EndModule			
Module="min-date: total reactive power"	0x41,0x83,140 ; -	unsigned long	4
EndModule			
Module="min-date: total appearent power"	0x41,0x83,141 ; -	unsigned long	4
EndModule			
Module="min-date: powerfactor"	0x41,0x83,142 ; -	unsigned long	4
EndModule			
Module="tariff index"	0x41,0x83,143 ; -	unsigned long	4
EndModule			
Module="act. work HT/LT consumption"	0x41,0x87,144 ; Wh	float	8
EndModule			
Module="react. work HT/LT cons."	0x41,0x87,145 ; varh	float	8
EndModule			
Module="today: act.Work HT/LT cons."	0x41,0x87,146 ; Wh	float	8
EndModule			
Module="today: react.Work HT/LT cons."	0x41,0x87,147 ; varh	float	8
EndModule			
Module="yday: act.Work HT/LT cons."	0x41,0x87,148 ; Wh	float	8
EndModule			
Module="yday: react.Work HT/LT cons."	0x41,0x87,149 ; varh	float	8
EndModule			
Module="tmonth:act.work HT/LT cons."	0x41,0x87,150 ; Wh	float	8
EndModule			
Module="tmonth:react.work HT/LT cons."	0x41,0x87,151 ; varh	float	8
EndModule			
Module="last month:act.work HT/LT cons."	0x41,0x87,152 ; Wh	float	8
EndModule			
Module="last month:react.work HT/LT con."	0x41,0x87,153 ; varh	float	8
EndModule			
Module="act. work HT/LT recovery"	0x41,0x87,154 ; Wh	float	8
EndModule			
Module="react. work HT/LT recovery"	0x41,0x87,155 ; varh	float	8
EndModule			
Module="today: act.work HT/LT recovery"	0x41,0x87,156 ; Wh	float	8
EndModule			
Module="today: react.work HT/LT recovery"	0x41,0x87,157 ; varh	float	8
EndModule			
Module="yday: act.work HT/LT recovery"	0x41,0x87,158 ; Wh	float	8
EndModule			
Module="yday: react.Work HT/LT recovery"	0x41,0x87,159 ; varh	float	8
EndModule			
Module="tmonth:act.work HT/LT recovery"	0x41,0x87,160 ; Wh	float	8
EndModule			
Module="tmonth:react.work HT/LT recov."	0x41,0x87,161 ; varh	float	8
EndModule			
Module="last month:act.work HT/LT recov."	0x41,0x87,162 ; Wh	float	8
EndModule			
Module="last month:react.work HT/LT rec."	0x41,0x87,163 ; varh	float	8
EndModule			
Module="status of relay 1 & 2"	0x41,0x87,164 ; -	unsigned long	8
EndModule			
Module="status of inputs 1 & 2(bitcoded)"	0x41,0x83,169 ; -	unsigned long	4
EndModule			
Module="act.period value P consumption"	0x41,0x83,170 ; W	float	4
EndModule			
Module="act.period value Q consumption"	0x41,0x83,171 ; var	float	4
EndModule			
Module="act.period value P recovery"	0x41,0x83,172 ; W	float	4
EndModule			
Module="act.period value Q recovery"	0x41,0x83,173 ; var	float	4
EndModule			
Module="act.period closing timestamp"	0x41,0x83,174 ; -	unsigned long	4
EndModule			
Module="mom.period value P consumption"	0x41,0x83,175 ; W	float	4
EndModule			
Module="mom.period value Q consumption"	0x41,0x83,176 ; var	float	4
EndModule			
Module="mom.period value P recovery"	0x41,0x83,177 ; W	float	4
EndModule			
Module="mom.period value Q recovery"	0x41,0x83,178 ; var	float	4

```

EndModule
Module="remaining time to close period"          0x41,0x83,179 ; s   unsigned long  4
EndModule
Module="period time"                            0x41,0x83,180 ; min unsigned long  4
EndModule

; modules for double-precision work-counter readouts
Module="act. work HT/LT cons. precision"        0x41,0x8F,165 ; Wh  double    16
EndModule
Module="react. work HT/LT cons. precis."        0x41,0x8F,166 ; varh double    16
EndModule
Module="act. work HT/LT rec. precision"         0x41,0x8F,167 ; Wh  double    16
EndModule
Module="react. work HT/LT rec. precis."         0x41,0x8F,168 ; varh double    16
EndModule

; modules for checking violated limit-values
Module="limit Violations Bytes 0..3"           0x41, 0x83, 200
EndModule
Module="limit Violations Bytes 4..7"           0x41, 0x83, 201
EndModule
Module="limit Violations Bytes 8..11"          0x41, 0x83, 202
EndModule
Module="limit Violations Bytes 12..15"         0x41, 0x83, 203
EndModule
Module="limit Violations Bytes 16..19"         0x41, 0x83, 204
EndModule

```

4 Output data

3 modules exist with output data which can be used if required.

The status flags of the device can be read and deleted, various values such as extremes or counter states can be reset and certain switch operations can be performed.

Module name	Configuration	Description
device status (read and reset)	0x91,0xA0	Output data byte <= 0: Deleting status bytes Input data 2 status bytes (see tables 3 and 4)
clear-commands	0xA0	Output data byte: Bit0: Reset of extreme values (only maxima) Bit1: Reset of extreme values (only minima) Bit2: Reset endless active power counter HT/NT consumption Bit3: Reset endless reactive power counter HT/NT consumption Bit4: Reset endless active power counter HT/NT recovery Bit5: Reset endless reactive power counter HT/NT recovery Bit 6 and 7: reserved
switch-commands	0x20	Bit0: to high tariff (bit must move from 0 to 1) Bit1: to low tariff (bit must move from 0 to 1) Bit2: Switch byte sequence of floating comma numbers To "reverse" (bit must move from 0 to 1) Bit3: Switch byte sequence of floating comma numbers to "standard" (bit must move from 0 to 1) Bit4,5,6 and 7: reserved

Table 2

The following table describe the meaning of the error flags.

Error status high byte

Bit	Explanation
0	Power failure has occurred
1	A limit has been violated
2	Reserved
3	External synchronous pulse missing
4	Reset has been performed
5	Device time valid (1 = no, 0 = yes)
6	Reserved
7	Reserved

Table 3

If the device is operated with an external synchronous pulse, BIT3 is set if the external synchronous pulse was not available when a period value was saved.
In general, all global error BITS set are reset by the master.

Error status low byte

Bit	Explanation
0	Rotating field error
1	Phase angle variation
2	I-Dir (k and l of the current transformer were swapped xxx)
3	Set pulse length for the pulse output is not possible
4	Battery voltage critical
5	Parameter error (default value replaces incorrect value)
6	At least one input is overloaded
7	Reserved

Table 4

5 Input data

The desired input data for the Profibus slave can be defined through any combination of the modules listed below.

Module name	Config.	Description	Unit	Format
voltage PH-N L1-L3	0x41,0x8B, 1	Voltage PH-N L1	V	float
		Voltage PH-N L2	V	float
		Voltage PH-N L3	V	float
voltage PH-PH L1-L3	0x41,0x8B, 2	Voltage PH-PH L1	V	float
		Voltage PH-PH L2	V	float
		Voltage PH-PH L3	V	float
current L1-L3	0x41,0x8B, 3	Current L1	A	float
		Current L2	A	float
		Current L3	A	float
current average. L1-L3	0x41,0x8B, 4	Current average value L1	A	float
		Current average value L2	A	float
		Current average value L3	A	float
Apparent power L1-L3	0x41,0x8B, 5	Apparent power L1	VA	float
		Apparent power L2	VA	float
		Apparent power L3	VA	float
active power L1-L3	0x41,0x8B, 6	Active power L1	W	float
		Active power L2	W	float
		Active power L3	W	float
reactive power L1-L3	0x41,0x8B, 7	Reactive power L1	var	float
		Reactive power L2	var	float

Module name	Config.	Description	Unit	Format
		Reactive power L3	var	float
cos Phi L1-L3	0x41,0x8B, 8	cos Phi L1		float
		cos Phi L2		float
		cos Phi L3		float
Power factor L1-L3	0x41,0x8B, 9	Power factor L1		float
		Power factor L2		float
		Power factor L3		float
THD voltage L1-L3	0x41.0xx8B, 10		%	float
		Voltage distortion factor L2	%	float
		Voltage distortion factor L3	%	float
Voltage 3rd harmonic L1-L3	0x41.0xx8B, 11	Voltage 3rd harmonic L1	%	float
		Voltage 3rd harmonic L2	%	float
		Voltage 3rd harmonic L3	%	float
Voltage 5th harmonic L1-L3	0x41.0xx8B, 12	Voltage 5th harmonic L1	%	float
		Voltage 5th harmonic L2	%	float
		Voltage 5th harmonic L3	%	float
Voltage 7th harmonic L1-L3	0x41.0xx8B, 13	Voltage 7th harmonic L1	%	float
		Voltage 7th harmonic L2	%	float
		Voltage 7th harmonic L3	%	float
Voltage 9th harmonic L1-L3	0x41.0xx8B, 14	Voltage 9th harmonic L1	%	float
		Voltage 9th harmonic L2	%	float
		Voltage 9th harmonic L3	%	float
Voltage 11th harmonic L1-L3	0x41.0xx8B, 15	Voltage 11th harmonic L1	%	float
		Voltage 11th harmonic L2	%	float
		Voltage 11th harmonic L3	%	float
Voltage 13th harmonic L1-L3	0x41.0xx8B, 16	Voltage 13th harmonic L1	%	float
		Voltage 13th harmonic L2	%	float
		Voltage 13th harmonic L3	%	float
Voltage 15th harmonic L1-L3	0x41.0xx8B, 17	Voltage 15th harmonic L1	%	float
		Voltage 15th harmonic L2	%	float
		Voltage 15th harmonic L3	%	float
Voltage 17th harmonic L1-L3	0x41.0xx8B, 18	Voltage 17th harmonic L1	%	float
		Voltage 17th harmonic L2	%	float
		Voltage 17th harmonic L3	%	float
Voltage 19th harmonic L1-L3	0x41.0xx8B, 19	Voltage 19th harmonic L1	%	float
		Voltage 19th harmonic L2	%	float
		Voltage 19th harmonic L3	%	float
Distortion current L1-L3	0x41.0xx8B, 20	Total harmonic currents L1	A	float
		Total harmonic currents L2	A	float
		Total harmonic currents L3	A	float
Current 3rd harmonic L1-L3	0x41.0xx8B, 21	Current 3rd harmonic L1	A	float
		Current 3rd harmonic L2	A	float
		Current 3rd harmonic L3	A	float
Current 5th harmonic L1-L3	0x41.0xx8B, 22	Current 5th harmonic L1	A	float
		Current 5th harmonic L2	A	float
		Current 5th harmonic L3	A	float
Current 7th harmonic L1-L3	0x41.0xx8B, 23	Current 7th harmonic L1	A	float
		Current 7th harmonic L2	A	float
		Current 7th harmonic L3	A	float
Current 9th harmonic L1-L3	0x41.0xx8B, 24	Current 9th harmonic L1	A	float
		Current 9th harmonic L2	A	float
		Current 9th harmonic L3	A	float
Current 11th harmonic L1-L3	0x41.0xx8B, 25	Current 11th harmonic L1	A	float
		Current 11th harmonic L2	A	float

Module name	Config.	Description	Unit	Format
		Current 11th harmonic L3	A	float
Current 13th harmonic L1-L3	0x41.0xx8B, 26	Current 13th harmonic L1	A	float
		Current 13th harmonic L2	A	float
		Current 13th harmonic L3	A	float
Current 15th harmonic L1-L3	0x41.0xx8B, 27	Current 15th harmonic L1	A	float
		Current 15th harmonic L2	A	float
		Current 15th harmonic L3	A	float
Current 17th harmonic L1-L3	0x41.0xx8B, 28	Current 17th harmonic L1	A	float
		Current 17th harmonic L2	A	float
		Current 17th harmonic L3	A	float
Current 19th harmonic L1-L3	0x41.0xx8B, 29	Current 19th harmonic L1	A	float
		Current 19th harmonic L2	A	float
		Current 19th harmonic L3	A	float
Max: voltage PH-N L1-L3	0x41.0xx8B, 30	Maximum: Voltage PH-N L1	V	float
		Maximum: Voltage PH-N L2	V	float
		Maximum: Voltage PH-N L3	V	float
Max: voltage PH-PH L1-L3	0x41.0xx8B, 31	Maximum: voltage PH-PH L1	V	float
		Maximum: Voltage PH-PH L2	V	float
		Maximum: Voltage PH-PH L3	V	float
Max: current L1-L3	0x41.0xx8B, 32	Maximum: Current L1	A	float
		Maximum: Current L2	A	float
		Maximum: Current L3	A	float
Max: current average L1-L3	0x41.0xx8B, 33	Maximum: Current average value L1	A	float
		Maximum: Current average value L2	A	float
		Maximum: Current average value L3	A	float
Max: apparent power L1-L3	0x41.0xx8B, 34	Maximum: Apparent power L1	VA	float
		Maximum: Apparent power L2	VA	float
		Maximum: Apparent power L3	VA	float
Max: active power L1-L3	0x41.0xx8B, 35	Maximum: Active power L1	W	float
		Maximum: Active power L2	W	float
		Maximum: Active power L3	W	float
Max: reactive power L1-L3	0x41.0xx8B, 36	Maximum: Reactive power L1	var	float
		Maximum: Reactive power L2	var	float
		Maximum: Reactive power L3	var	float
Max: cos Phi L1-L3	0x41.0xx8B, 37	Maximum: cos Phi L1		float
		Maximum: cos Phi L2		float
		Maximum: cos Phi L3		float
Max: powerfactor L1-L3	0x41.0xx8B, 38	Maximum: Power factor L1		float
		Maximum: Power factor L2		float
		Maximum: Power factor L3		float
max: THD voltage L1-L3	0x41.0xx8B, 39	Maximum: Voltage distortion factor L1	%	float
		Maximum: Voltage distortion factor L2	%	float
		Maximum: Voltage distortion factor L3	%	float
Max: voltage 3rd harmonic L1-L3	0x41.0xx8B, 40	Maximum: Voltage 3rd harmonic L1	%	float
		Maximum: Voltage 3rd harmonic L2	%	float
		Maximum: Voltage 3rd harmonic L3	%	float
Max: voltage 5th harmonic L1-L3	0x41.0xx8B, 41	Maximum: Voltage 5th harmonic L1	%	float
		Maximum: Voltage 5th harmonic L2	%	float
		Maximum: Voltage 5th harmonic L3	%	float
Max: voltage 7th harmonic L1-L3	0x41.0xx8B, 42	Maximum: Voltage 7th harmonic L1	%	float
		Maximum: Voltage 7th harmonic L2	%	float
		Maximum: Voltage 7th harmonic L3	%	float
Max: voltage 9th harmonic L1-L3	0x41.0xx8B, 43	Maximum: Voltage 9th harmonic L1	%	float
		Maximum: Voltage 9th harmonic L2	%	float

Module name	Config.	Description	Unit	Format
		Maximum: Voltage 9th harmonic L3	%	float
Max: voltage 11th harmonic L1-L3	0x41.0xx8B, 44	Maximum: Voltage 11th harmonic L1	%	float
		Maximum: Voltage 11th harmonic L2	%	float
		Maximum: Voltage 11th harmonic L3	%	float
Max: voltage 13th harmonic L1-L3	0x41.0xx8B, 45	Maximum: Voltage 13th harmonic L1	%	float
		Maximum: Voltage 13th harmonic L2	%	float
		Maximum: Voltage 13th harmonic L3	%	float
Max: voltage 15th harmonic L1-L3	0x41.0xx8B, 46	Maximum: Voltage 15th harmonic L1	%	float
		Maximum: Voltage 15th harmonic L2	%	float
		Maximum: Voltage 15th harmonic L3	%	float
Max: voltage 17th harmonic L1-L3	0x41.0xx8B, 47	Maximum: Voltage 17th harmonic L1	%	float
		Maximum: Voltage 17th harmonic L2	%	float
		Maximum: Voltage 17th harmonic L3	%	float
Max: voltage 19th harmonic L1-L3	0x41.0xx8B, 48	Maximum: Voltage 19th harmonic L1	%	float
		Maximum: Voltage 19th harmonic L2	%	float
		Maximum: Voltage 19th harmonic L3	%	float
Max: distortion current L1-L3	0x41.0xx8B, 49	Maximum: Total harmonic currents L1	A	float
		Maximum: Total harmonic currents L2	A	float
		Maximum: Total harmonic currents L3	A	float
Max: current 3rd harmonic L1-L3	0x41.0xx8B, 50	Maximum: Current 3rd harmonic L1	A	float
		Maximum: Current 3rd harmonic L2	A	float
		Maximum: Current 3rd harmonic L3	A	float
Max: current 5th harmonic L1-L3	0x41.0xx8B, 51	Maximum: Current 5th harmonic L1	A	float
		Maximum: Current 5th harmonic L2	A	float
		Maximum: Current 5th harmonic L3	A	float
Max: current 7th harmonic L1-L3	0x41.0xx8B, 52	Maximum: Current 7th harmonic L1	A	float
		Maximum: Current 7th harmonic L2	A	float
		Maximum: Current 7th harmonic L3	A	float
Max: current 9th harmonic L1-L3	0x41.0xx8B, 53	Maximum: Current 9th harmonic L1	A	float
		Maximum: Current 9th harmonic L2	A	float
		Maximum: Current 9th harmonic L3	A	float
Max: current 11th harmonic L1-L3	0x41.0xx8B, 54	Maximum: Current 11th harmonic L1	A	float
		Maximum: Current 11th harmonic L2	A	float
		Maximum: Current 11th harmonic L3	A	float
Max: current 13th harmonic L1-L3	0x41.0xx8B, 55	Maximum: Current 13th harmonic L1	A	float
		Maximum: Current 13th harmonic L2	A	float
		Maximum: Current 13th harmonic L3	A	float
Max: current 15th harmonic L1-L3	0x41.0xx8B, 56	Maximum: Current 15th harmonic L1	A	float
		Maximum: Current 15th harmonic L2	A	float
		Maximum: Current 15th harmonic L3	A	float
Max: current 17th harmonic L1-L3	0x41.0xx8B, 57	Maximum: Current 17th harmonic L1	A	float
		Maximum: Current 17th harmonic L2	A	float
		Maximum: Current 17th harmonic L3	A	float
Max: current 19th harmonic L1-L3	0x41.0xx8B, 58	Maximum: Current 19th harmonic L1	A	float
		Maximum: Current 19th harmonic L2	A	float
		Maximum: Current 19th harmonic L3	A	float
Min: voltage PH-N L1-L3	0x41.0xx8B, 59	Minimum: Voltage PH-N L1	V	float
		Minimum: Voltage PH-N L2	V	float
		Minimum: Voltage PH-N L3	V	float
Min: voltage PH-PH L1-L3	0x41.0xx8B, 60	Minimum: voltage PH-PH L1	V	float
		Minimum: Voltage PH-PH L2	V	float
		Minimum: Voltage PH-PH L3	V	float
Min: current L1-L3	0x41.0xx8B, 61	Minimum: Current L1	A	float
		Minimum: Current L2	A	float

Module name	Config.	Description	Unit	Format
		Minimum: Current L3	A	float
Min: current average L1-L3	0x41.0xx8B, 62	Minimum: Current average value L1	A	float
		Minimum: Current average value L2	A	float
		Minimum: Current average value L3	A	float
Min: apparent power L1-L3	0x41.0xx8B, 63	Minimum: Apparent power L1	VA	float
		Minimum: Apparent power L2	VA	float
		Minimum: Apparent power L3	VA	float
Min: active power L1-L3	0x41.0xx8B, 64	Minimum: Active power L1	W	float
		Minimum: Active power L2	W	float
		Minimum: Active power L3	W	float
Min: reactive power L1-L3	0x41.0xx8B, 65	Minimum: Reactive power L1	var	float
		Minimum: Reactive power L2	var	float
		Minimum: Reactive power L3	var	float
Min: cos Phi L1-L3	0x41.0xx8B, 66	Minimum: cos Phi L1		float
		Minimum: cos Phi L2		float
		Minimum: cos Phi L3		float
Min: power factor L1-L3	0x41.0xx8B, 67	Minimum: Power factor L1		float
		Minimum: Power factor L2		float
		Minimum: Power factor L3		float
Max-date: voltage PH-N L1-L3	0x41.0xx8B, 68	Maximum date: Voltage PH-N L1		unsigned long
		Maximum date: Voltage PH-N L2		unsigned long
		Maximum date: Voltage PH-N L3		unsigned long
Max-date: voltage PH-PH L1-L3	0x41.0xx8B, 69	Maximum date: Voltage PH-PH L1		unsigned long
		Maximum date: Voltage PH-PH L2		unsigned long
		Maximum date: Voltage PH-PH L3		unsigned long
Max-date: current L1-L3	0x41.0xx8B, 70	Maximum date: Current L1		unsigned long
		Maximum date: Current L2		unsigned long
		Maximum date: Current L3		unsigned long
Max-date: current average L1-L3	0x41.0xx8B, 71	Maximum date: Current average value L1		unsigned long
		Maximum date: Current average value L2		unsigned long
		Maximum date: Current average value L3		unsigned long
Max-date: apparent power L1-L3	0x41.0xx8B, 72	Maximum date: Apparent power L1		unsigned long
		Maximum date: Apparent power L2		unsigned long
		Maximum date: Apparent power L3		unsigned long
Max-date: active power L1-L3	0x41.0xx8B, 73	Maximum date: Active power L1		unsigned long
		Maximum date: Active power L2		unsigned long
		Maximum date: Active power L3		unsigned long
Max-date: reactive power L1-L3	0x41.0xx8B, 74	Maximum date: Reactive power L1		unsigned long

Module name	Config.	Description	Unit	Format
		Maximum date: Reactive power L2		unsigned long
		Maximum date: Reactive power L3		unsigned long
Max-date: cos Phi L1-L3	0x41.0xx8B, 75	Maximum date: cos Phi L1		unsigned long
		Maximum date: cos Phi L2		unsigned long
		Maximum date: cos Phi L3		unsigned long
Max-date: power factor L1-L3	0x41.0xx8B, 76	Maximum date: Power factor L1		unsigned long
		Maximum date: Power factor L2		unsigned long
		Maximum date: Power factor L3		unsigned long
Max-date: THD voltage L1-L3	0x41.0xx8B, 77	Maximum date: Voltage distortion factor L1		unsigned long
		Maximum date: Voltage distortion factor L2		unsigned long
		Maximum date: Voltage distortion factor L3		unsigned long
Max-date: voltage 3rd harmonic L1-L3	0x41.0xx8B, 78	Maximum date: Voltage 3rd harmonic L1		unsigned long
		Maximum date: Voltage 3rd harmonic L2		unsigned long
		Maximum date: Voltage 3rd harmonic L3		unsigned long
Max-date: voltage 5th harmonic L1-L3	0x41.0xx8B, 79	Maximum date: Voltage 5th harmonic L1		unsigned long
		Maximum date: Voltage 5th harmonic L2		unsigned long
		Maximum date: Voltage 5th harmonic L3		unsigned long
Max-date: voltage 7th harmonic L1-L3	0x41.0xx8B, 80	Maximum date: Voltage 7th harmonic L1		unsigned long
		Maximum date: Voltage 7th harmonic L2		unsigned long
		Maximum date: Voltage 7th harmonic L3		unsigned long
Max-date: voltage 9th harmonic L1-L3	0x41.0xx8B, 81	Maximum date: Voltage 9th harmonic L1		unsigned long
		Maximum date: Voltage 9th harmonic L2		unsigned long
		Maximum date: Voltage 9th harmonic L3		unsigned long
Max-date: voltage 11th harmonic L1-L3	0x41.0xx8B, 82	Maximum date: Voltage 11th harmonic L1		unsigned long
		Maximum date: Voltage 11th harmonic L2		unsigned long
		Maximum date: Voltage 11th harmonic L3		unsigned long
Max-date: voltage 13th harmonic L1-L3	0x41.0xx8B, 83	Maximum date: Voltage 13th harmonic L1		unsigned long
		Maximum date: Voltage 13th harmonic L2		unsigned long
		Maximum date: Voltage 13th harmonic L3		unsigned long

Module name	Config.	Description	Unit	Format
Max-date: voltage 15th harmonic L1-L3	0x41.0xx8B, 84	Maximum date: Voltage 15th harmonic L1		unsigned long
		Maximum date: Voltage 15th harmonic L2		unsigned long
		Maximum date: Voltage 15th harmonic L3		unsigned long
Max-date: voltage 17th harmonic L1-L3	0x41.0xx8B, 85	Maximum date: Voltage 17th harmonic L1		unsigned long
		Maximum date: Voltage 17th harmonic L2		unsigned long
		Maximum date: Voltage 17th harmonic L3		unsigned long
Max-date: voltage 19th harmonic L1-L3	0x41.0xx8B, 86	Maximum date: Voltage 19th harmonic L1		unsigned long
		Maximum date: Voltage 19th harmonic L2		unsigned long
		Maximum date: Voltage 19th harmonic L3		unsigned long
Max-date: distortion current L1-L3	0x41.0xx8B, 87	Maximum date: Total harmonic currents L1		unsigned long
		Maximum date: Total harmonic currents L2		unsigned long
		Maximum date: Total harmonic currents L3		unsigned long
Max-date: current 3rd harmonic L1-L3	0x41.0xx8B, 88	Maximum date: Current 3rd harmonic L1		unsigned long
		Maximum date: Current 3rd harmonic L2		unsigned long
		Maximum date: Current 3rd harmonic L3		unsigned long
Max-date: current 5th harmonic L1-L3	0x41.0xx8B, 89	Maximum date: Current 5th harmonic L1		unsigned long
		Maximum date: Current 5th harmonic L2		unsigned long
		Maximum date: Current 5th harmonic L3		unsigned long
Max-date: current 7th harmonic L1-L3	0x41.0xx8B, 90	Maximum date: Current 7th harmonic L1		unsigned long
		Maximum date: Current 7th harmonic L2		unsigned long
		Maximum date: Current 7th harmonic L3		unsigned long
Max-date: current 9th harmonic L1-L3	0x41.0xx8B, 91	Maximum date: Current 9th harmonic L1		unsigned long
		Maximum date: Current 9th harmonic L2		unsigned long
		Maximum date: Current 9th harmonic L3		unsigned long
Max-date: current 11th harmonic L1-L3	0x41.0xx8B, 92	Maximum date: Current 11th harmonic L1		unsigned long
		Maximum date: Current 11th harmonic L2		unsigned long
		Maximum date: Current 11th harmonic L3		unsigned long
Max-date: current 13th harmonic L1-L3	0x41.0xx8B, 93	Maximum date: Current 13th harmonic L1		unsigned long
		Maximum date: Current 13th harmonic L2		unsigned long

Module name	Config.	Description	Unit	Format
		Maximum date: Current 13th harmonic L3		unsigned long
Max-date: current 15th harmonic L1-L3	0x41.0xx8B, 94	Maximum date: Current 15th harmonic L1		unsigned long
		Maximum date: Current 15th harmonic L2		unsigned long
		Maximum date: Current 15th harmonic L3		unsigned long
Max-date: current 17th harmonic L1-L3	0x41.0xx8B, 95	Maximum date: Current 17th harmonic L1		unsigned long
		Maximum date: Current 17th harmonic L2		unsigned long
		Maximum date: Current 17th harmonic L3		unsigned long
Max-date: current 19th harmonic L1-L3	0x41.0xx8B, 96	Maximum date: Current 19th harmonic L1		unsigned long
		Maximum date: Current 19th harmonic L2		unsigned long
		Maximum date: Current 19th harmonic L3		unsigned long
Min-date: voltage PH-N L1-L3	0x41.0xx8B, 97	Minimum date: Voltage PH-N L1		unsigned long
		Minimum date: Voltage PH-N L2		unsigned long
		Minimum date: Voltage PH-N L3		unsigned long
Min-date: voltage PH-PH L1-L3	0x41.0xx8B, 98	Minimum date: Voltage PH-PH L1		unsigned long
		Minimum date: Voltage PH-PH L2		unsigned long
		Minimum date: Voltage PH-PH L3		unsigned long
Min-date: current L1-L3	0x41.0xx8B, 99	Minimum date: Current L1		unsigned long
		Minimum date: Current L2		unsigned long
		Minimum date: Current L3		unsigned long
Min-date: current avg L1-L3	0x41.0x8B, 100	Minimum date: Current average value L1		unsigned long
		Minimum date: Current average value L2		unsigned long
		Minimum date: Current average value L3		unsigned long
Min-date: apparent power L1-L3	0x41.0x8B, 101	Minimum date: Apparent power L1		unsigned long
		Minimum date: Apparent power L2		unsigned long
		Minimum date: Apparent power L3		unsigned long
Min-date: active power L1-L3	0x41.0x8B, 102	Minimum date: Active power L1		unsigned long
		Minimum date: Active power L2		unsigned long
		Minimum date: Active power L3		unsigned long
Min-date: reactive power L1-L3	0x41.0x8B, 103	Minimum date: Reactive power L1		unsigned long

Module name	Config.	Description	Unit	Format
		Minimum date: Reactive power L2		unsigned long
		Minimum date: Reactive power L3		unsigned long
Min-date: cos Phi L1-L3	0x41.0x8B, 104	Maximum date: cos Phi L1		unsigned long
		Maximum date: cos Phi L2		unsigned long
		Maximum date: cos Phi L3		unsigned long
Min-date: power factor L1-L3	0x41.0x8B, 105	Minimum date: Power factor L1		unsigned long
		Minimum date: Power factor L2		unsigned long
		Minimum date: Power factor L3		unsigned long
frequency	0x41.0x83, 106	Network frequency	Hz	float
NeutralXXX conductor current	0x41.0x83, 107	Neutral conductor current	A	float
Average neutralXXX conductor current	0x41.0x83, 108	Average value neutral conductor current	A	float
total active power	0x41.0x83, 109	Total active power	W	float
total reactive power	0x41.0x83, 110	Total reactive power	var	float
total apparent power	0x41.0x83, 111	Total apparent power	VA	float
Total power factor	0x41.0x83, 112	Power factor		float
error status	0x41.0x83, 113	Error state		unsigned long
time	0x41.0x83, 114	Time		unsigned long
max: frequency	0x41.0x83, 115	Maximum: Network frequency	Hz	float
Max: neutral conductor current XXX	0x41.0x83, 116	Maximum: Neutral conductor current	A	float
Max: avg neutral conductor current XXX	0x41.0x83, 117	Maximum: Average value neutral conductor current	A	float
Max: total active power	0x41.0x83, 118	Maximum: Total active power	W	float
Max: total reactive power	0x41.0x83, 119	Maximum: Total reactive power	var	float
Max: total apparent power	0x41.0x83, 120	Maximum: Total apparent power	VA	float
Max: power factor	0x41.0x83, 121	Maximum: Power factor		float
Min: frequency	0x41.0x83, 122	Minimum: Network frequency	Hz	float
Min: neutral conductor current XXX	0x41.0x83, 123	Minimum: Neutral conductor current	A	float
Min: avg neutral conductor current XXX	0x41.0x83, 124	Minimum: Average value neutral conductor current	A	float
Min: total active power	0x41.0x83, 125	Minimum: Total active power	W	float
Min: total reactive power	0x41.0x83, 126	Minimum: Total reactive power	var	float
Min: total apparent power	0x41.0x83, 127	Minimum: Total apparent power	VA	float
Min: power factor	0x41.0x83, 128	Minimum: Power factor		float
Max-date: frequency	0x41.0x83, 129	Maximum date: Network frequency		unsigned long
Max-date: neutral conductor current XXX	0x41.0x83, 130	Maximum date: Neutral conductor current		unsigned long
Max-date: avg. neutral conductor current XXX	0x41.0x83, 131	Maximum date: Average value neutral conductor current		unsigned long
Max-date: total active power	0x41.0x83, 132	Maximum date: Total active power		unsigned long
Max-date: total reactive power	0x41.0x83, 133	Maximum date: Total reactive power		unsigned long

Module name	Config.	Description	Unit	Format
Max-date: total apparent power	0x41.0x83, 134	Maximum date: Total apparent power		unsigned long
Max-date: power factor	0x41.0x83, 135	Maximum date: Power factor		unsigned long
Min-date: frequency	0x41.0x83, 136	Minimum date: Network frequency		unsigned long
Min-date: neutral conductor current XXX	0x41.0x83, 137	Minimum date: Neutral conductor current		unsigned long
Min-date: avg. neutral conductor current XXX	0x41.0x83, 138	Minimum date: Average value neutral conductor current		unsigned long
Min-date: total active power	0x41.0x83, 139	Minimum date: Total active power		unsigned long
Min-date: total reactive power	0x41.0x83, 140	Minimum date: Total reactive power		unsigned long
Min-date: total apparent power	0x41.0x83, 141	Minimum date: Total apparent power		unsigned long
Min-date: power factor	0x41.0x83, 142	Minimum date: Power factor		unsigned long
tariff index	0x41.0x83, 143	Tariff index		unsigned long
act. work HT/LT consumption	0x41.0x87, 144	Active power meter count (HT/consumption)	Wh	float
		Active energy meter count (LT/consumption)	Wh	float
react. work HT/LT cons.	0x41.0x87, 145	Reactive energy meter count (HT/consumption)	varh	float
		Reactive energy meter count (LT/consumption)	varh	float
Today: active energyXXX HT/LT cons.	0x41.0x87, 146	Today: active energy HT/consumption	Wh	float
		Today: active energy LT/consumption	Wh	float
Today: reactive energyXXX HT/LT cons.	0x41.0x87, 147	Today: reactive energy HT/consumption	varh	float
		Today: reactive energy LT/consumption	varh	float
Previous day: act. work HT/LT cons.	0x41.0x87, 148	Previous day: active energy HT/consumption	Wh	float
		Previous day: active energy LT/consumption	Wh	float
y/day: react.Work HT/LT cons.	0x41.0x87, 149	Previous day: reactive energy HT/consumption	varh	float
		Previous day: reactive energy LT/consumption	varh	float
t'month:act.work HT/LT cons.	0x41,0x87,150	Current month: active energy HT/consumption	Wh	float
		Current month: active energy LT/consumption	Wh	float
t'month:react.work HT/LT cons.	0x41,0x87,151	Current month: reactive energy HT/consumption	varh	float
		Current month: reactive energy LT/consumption	varh	float
last month:act.work HT/LT cons.	0x41,0x87,152	Last month: active energy HT/consumption	Wh	float
		Last month: reactive energy LT/consumption	Wh	float
Last month:react.work HT/LT con.	0x41,0x87,153	Last month: reactive energy HT/consumption	varh	float
		Last month: reactive energy LT/consumption	varh	float

Module name	Config.	Description	Unit	Format
act. work HT/LT recovery	0x41,0x87,154	Active energy meter count (HT/recovery)	Wh	float
		Active energy meter count (LT/recovery)	Wh	float
react. work HT/LT recovery	0x41,0x87,155	Reactive energy meter count (HT/recovery)	varh	float
		Reactive energy meter count (LT/recovery)	varh	float
today: act.Work HT/LT recovery	0x41,0x87,156	Today: active energy HT recovery	Wh	float
		Today: active energy LT recovery	Wh	float
today: react.Work HT/LT recovery	0x41,0x87,157	Today: reactive energy HT recovery	varh	float
		Today: reactive energy LT recovery	varh	float
y/day: act.Work HT/LT recovery	0x41,0x87,158	Previous day: active energy HT recovery	Wh	float
		Previous day: active energy LT recovery	Wh	float
y/day: react.Work HT/LT recovery	0x41,0x87,159	Previous day: reactive energy HT recovery	varh	float
		Previous day: reactive energy LT recovery	varh	float
t'month:act.work HT/LT recovery	0x41,0x87,160	Current month: active energy HT recovery	Wh	float
		Current month: active energy LT recovery	Wh	float
t'month:react.work HT/LT recov.	0x41,0x87,161	Current month: reactive energy HT recovery	varh	float
		Current month: reactive energy LT recovery	varh	float
last month:act.work HT/LT recov.	0x41,0x87,162	Last month: active energy HT recovery	Wh	float
		Last month: reactive energy LT recovery	Wh	float
last month:react.work HT/LT rec.	0x41,0x87,163	Last month: reactive energy HT recovery	varh	float
		Last month: reactive energy LT recovery	varh	float
status of relay 1 & 2	0x41,0x87,164	Condition relay 1		unsigned long
		Condition relay 2		unsigned long
status of inputs 1 & 2 (bitcoded)	0x41,0x83,169	Bit 0: Condition Input 1 (Sync) Bit 1: Condition Input 2 (Tariff)		unsigned long
act.period value P consumption	0x41,0x83,170	Last saved period value active power consumption	W	float
act.period value Q consumption	0x41,0x83,171	Last saved period value reactive power consumption	var	float
act.period value P recovery	0x41,0x83,172	Last saved period value active power recovery	W	float
act.period value Q recovery	0x41,0x83,173	Last saved period value reactive power recovery	var	float
act.period closing timestamp	0x41,0x83,174	Timestamp of the period values last saved	s	unsigned long
inst.period value P consumption	0x41,0x83,175	Instantaneous value of the current period active power consumption	W	float
inst.period value Q consumption	0x41,0x83,176	Instantaneous value of the current period reactive power consumption	var	float

Module name	Config.	Description	Unit	Format
inst.period value P recovery	0x41,0x83,177	Instantaneous value of the current period active power recovery	W	float
inst.period value Q recovery	0x41,0x83,178	Instantaneous value of the current period reactive power recovery	var	float
remaining time to close period	0x41,0x83,179	Remaining period time	s	unsigned long
period time	0x41,0x83,180	Period length	min	unsigned long
phase-angle U L12	0x41,0x83,181	Phase angle U L12	Degree	float
phase-angle U L23	0x41,0x83,182	Phase angle U L23	Degree	float
phase-angle U L31	0x41,0x83,183	Phase angle U L31	Degree	float
voltage asymmetric	0x41,0x83,184	Voltage asymmetry	%	float
act. work HT/LT cons. precision	0x41,0x8F,165	Active power meter count (HT/consumption)	Wh	double
		Active energy meter count (LT/consumption)	Wh	double
react. work HT/LT cons. precis.	0x41,0x8F,166	Reactive energy meter count (HT/consumption)	varh	double
		Reactive energy meter count (LT/consumption)	varh	double
act. work HT/LT rec. precision	0x41,0x8F,167	Active energy meter count (HT/recovery)	Wh	double
		Active energy meter count (LT/recovery)	Wh	double
react. work HT/LT rec. precis.	0x41,0x8F,168	Reactive energy meter count (HT/recovery)	varh	double
		Reactive energy meter count (LT/recovery)	varh	double
limit violations bytes 0..3	0x41,0x83,200	Limit violations bytes 0..3 (bitcoded) See table 6		DWORD
Limit violations bytes 4..7	0x41,0x83,201	Limit violations bytes 4..7 (bitcoded) See table 6		DWORD
Limit violations bytes 8..11	0x41,0x83,202	Limit violations bytes 8..11 (bitcoded) See table 6		DWORD
Limit violations bytes 12..15	0x41,0x83,203	Limit violations bytes 12..15 (bitcoded) See table 6		DWORD
Limit violations bytes 16..19	0x41,0x83,204	Limit violations bytes 16..19 (bitcoded) See table 6		DWORD

Table 5

Coding of the limit violations in described in table 6.

Byte limit	Value	Explanation
0	BIT-CODED	.0: 1st limit voltage PH-N L1 .1: 1st limit voltage PH-N L2 .2: 1st limit voltage PH-N L3 .3: 2nd limit voltage PH-N L1 .4: 2nd limit voltage PH-N L2 .5: 2nd limit voltage PH-N L3 .6: 1st limit voltage PH-PH L1 .7: 1st limit voltage PH-PH L2
1	BIT-CODED	.0: 1st limit voltage PH-PH L3 .1: 2nd limit voltage PH-PH L1 .2: 2nd limit voltage PH-PH L2 .3: 2nd limit voltage PH-PH L3 .4: 1st limit current L1 .5: 1st limit current L2 .6: 1st limit current L3 .7: 2nd limit current L1
2	BIT-CODED	.0: 2nd limit current L2 .1: 2nd limit current L3 .2: 1st limit current average value L1 .3: 1st limit current average value L2 .4: 1st limit current average value L3 .5: 2nd limit current average value L1 .6: 2nd limit current average value L2 .7: 2nd limit current average value L3
3	BIT-CODED	.0: 1st limit apparent power L1 .1: 1st limit apparent power L2 .2: 1st limit apparent power L3 .3: 2nd limit apparent power L1 .4: 2nd limit apparent power L2 .5: 2nd limit apparent power L3 .6: 1st limit active power L1 .7: 1st limit active power L2
4	BIT-CODED	.0: 1st limit active power L3 .1: 2nd limit active power L1 .2: 2nd limit active power L2 .3: 2nd limit active power L3 .4: 1st limit reactive power L1 .5: 1st limit reactive power L2 .6: 1st limit reactive power L3 .7: 2nd limit reactive power L1
5	BIT-CODED	.0: 2nd limit reactive power L2 .1: 2nd limit reactive power L3 .2: 1st limit cos Phi L1 .3: 1st limit cos Phi L2 .4: 1st limit cos Phi L3 .5: 2nd limit cos Phi L1 .6: 2nd limit cos Phi L2 .7: 2nd limit cos Phi L3
6	BIT-CODED	.0: 1st limit power factor L1 .1: 1st limit power factor L2 .2: 1st limit power factor L3 .3: 2nd limit power factor L1 .4: 2nd limit power factor L2 .5: 2nd limit power factor L3 .6: 1st limit voltage distortion factor L1 .7: 1st limit voltage distortion factor L2

7	BIT-CODED	.0: 1st limit voltage distortion factor L3 .1: 2nd limit voltage distortion factor L1 .2: 1nd limit voltage distortion factor L2 .3: 2nd limit voltage distortion factor L3 .4: 1st limit voltage 3rd harmonic L1 .5: 1st limit voltage 3rd harmonic L2 .6: 1st limit voltage 3rd harmonic L3 .7: 2nd limit voltage 3rd harmonic L1
8	BIT-CODED	.0: 2nd limit voltage 3rd harmonic L2 .1: 2nd limit voltage 3rd harmonic L3 .2: 1st limit voltage 5th harmonic L1 .3: 1st limit voltage 5th harmonic L2 .4: 1st limit voltage 5th harmonic L3 .5: 2nd limit voltage 5th harmonic L1 .6: 2nd limit voltage 5th harmonic L2 .7: 2nd limit voltage 5th harmonic L3
9	BIT-CODED	.0: 1st limit voltage 7th harmonic L1 .1: 1nd limit voltage 7th harmonic L2 .2: 1st limit voltage 7th harmonic L3 .3: 2nd limit voltage 7th harmonic L1 .4: 2nd limit voltage 7th harmonic L2 .5: 2nd limit voltage 7th harmonic L3 .6: 1st limit voltage 9th harmonic L1 .7: 1st limit voltage 9th harmonic L2
10	BIT-CODED	.0: 1st limit voltage 9th harmonic L3 .1: 2nd limit voltage 9th harmonic L1 .2: 2nd limit voltage 9th harmonic L2 .3: 2nd limit voltage 9th harmonic L3 .4: 1st limit voltage 11th harmonic L1 .5: 1st limit voltage 11th harmonic L2 .6: 1st limit voltage 11th harmonic L3 .7: 2nd limit voltage 11th harmonic L1
11	BIT-CODED	.0: 2nd limit voltage 11th harmonic L2 .1: 2nd limit voltage 11th harmonic L3 .2: 1st limit voltage 13th harmonic L1 .3: 1st limit voltage 13th harmonic L2 .4: 1st limit voltage 13th harmonic L3 .5: 2nd limit voltage 13th harmonic L1 .6: 2nd limit voltage 13th harmonic L2 .7: 2nd limit voltage 13th harmonic L3
12	BIT-CODED	.0: 1st limit total harmonic currents L1 .1: 1st limit total harmonic currents L2 .2: 1st limit total harmonic currents L3 .3: 2nd limit total harmonic currents L1 .4: 2nd limit total harmonic currents L2 .5: 2nd limit total harmonic currents L3 .6: 1st limit current 3rd harmonic L1 .7: 1st limit current 3rd harmonic L2
13	BIT-CODED	.0: 1st limit current 3rd harmonic L3 .1: 2nd limit current 3rd harmonic L1 .2: 2nd limit current 3rd harmonic L2 .3: 2nd limit current 3rd harmonic L3 .4: 1st limit current 5th harmonic L1 .5: 1st limit current 5th harmonic L2 .6: 1st limit current 5th harmonic L3 .7: 2nd limit current 5th harmonic L1

14	BIT-CODED	.0: 2nd limit current 5th harmonic L2 .1: 2nd limit current 5th harmonic L3 .2: 1st limit current 7th harmonic L1 .3: 1st limit current 7th harmonic L2 .4: 1st limit current 7th harmonic L3 .5: 2nd limit current 7th harmonic L1 .6: 2nd limit current 7th harmonic L2 .7: 2nd limit current 7th harmonic L3
15	BIT-CODED	.0: 1st limit current 9th harmonic L1 .1: 1st limit current 9th harmonic L2 .2: 1st limit current 9th harmonic L3 .3: 2nd limit current 9th harmonic L1 .4: 2nd limit current 9th harmonic L2 .5: 2nd limit current 9th harmonic L3 .6: 1st limit current 11th harmonic L1 .7: 1st limit current 11th harmonic L2
16	BIT-CODED	.0: 1st limit current 11th harmonic L3 .1: 2nd limit current 11th harmonic L1 .2: 2nd limit current 11th harmonic L2 .3: 2nd limit current 11th harmonic L3 .4: 1st limit current 13th harmonic L1 .5: 1st limit current 13th harmonic L2 .6: 1st limit current 13th harmonic L3 .7: 2nd limit current 13th harmonic L1
17	BIT-CODED	.0: 2nd limit current 13th harmonic L2 .1: 2nd limit current 13th harmonic L3 .2: 1st limit network frequency .3: 2nd limit network frequency .4: 1st limit neutral conductor current .5: 2nd limit neutral conductor current .6: 1st limit average value neutral conductor current .7: 2nd limit average value neutral conductor current
18	BIT-CODED	.0: 1st limit total active power .1: 2nd limit total active power .2: 1st limit total reactive power .3: 2nd limit total reactive power .4: 1st limit total apparent power .5: 2nd limit total apparent power .6: 1st limit power factor .7: 2nd limit power factor
19		Reserved

Table 4

6 Example for integration into a Simatic S7-300 control

Since the 300-type controls from Siemens cannot process any consistent data of 3 or >4 bytes, the data have to be read using SFC14. The following example should help illustrate this.

```
// In the hardware configurator the "Frequency" module was projected to the input address 24.
// This module is 4-bytes in length (consistent) and can therefore be
// evaluated immediately
L   ED 24      // Frequency
T   MD 24
```

```
// The module "Voltage PH-N L1-L3" was projected to the input address 0 and
// the module "Current L1-L3" was projected to the input address 12.
// These modules each have 12 bytes of consistent length (3 * 4 bytes real) and can
// be read out using SFC14.
```

```
CALL "DPRD_DAT"      // SFC 14
LADDR :=W#16#0      // projected E-address of the module
RET_VAL:=MW120      // any measured value for possible error codes
RECORD :=P#DB4.DBX0.0 BYTE 12 // Pointer target area of data
```

```
L   DB4.DBD 0      // U L1
T   MD 0
```

```
L   DB4.DBD 4      // U L2
T   MD 4
```

```
L   DB4.DBD 8      // U L3
T   MD 8
```

```
CALL "DPRD_DAT"      // SFC 14
LADDR :=W#16#C      // projected E-address of the module
RET_VAL:=MW120      // any measured value for possible error codes
RECORD :=P#DB4.DBX12.0 BYTE 12 // Pointer target area of data
```

```
L   DB4.DBD 12     // I L1
T   MD 12
```

```
L   DB4.DBD 16     // I L2
T   MD 16
```

```
L   DB4.DBD 20     // I L3
T   MD 20
```

Appendix:

Data point description for the Modbus protocol RTU and ASCII

Table of contents

1	SUPPORTED MODBUS COMMANDS	2
2	DATA FORMATS	2
3	INTERFACE PARAMETERS	4
4	DEVICE SETTINGS	5
5	COMMANDS	10
6	LIMIT VIOLATIONS	11
7	DATA POINTS	15
8	DEVICE INFORMATION	26

1 Supported Modbus commands

0x02	Read Discrete Inputs
0x04	Read Input Registers
0x06	Write Single Input Register
0x10	Write Multiple Registers
0x2B	Read Device Identification

The multimes F144 does not support broadcast commands. All the Modbus commands described are device-specific commands (in accordance with Modbus definition, the required address must be set -1 in the request telex)

2 Data formats

(unsigned) short: 0x1234

Address	+0	+1
Contents	0x12	0x34

Rule for byte sequence:
MSB before LSB

(unsigned) long (int32 Big Endian): 0x12345678

Address	+0	+1	+2	+3
Contents	0x12	0x34	0x56	0x78

Rule for byte sequence:
MSB before LSB

float (Big Endian):

Format	Complies with the IEEE 754 standard
Representation	4 bytes
Accuracy	24 bits (> represent >7 decimal points)
Composition	24-bit mantissa; 8-bit exponent
Mantissa	24 bits (M) + 1 bit (S) The MSB of the mantissa is always 1 => it is not saved separately! S = sign of the mantissa: S = 1 > negative number; S = 0 > positive number
Exponent	8 bits (0-255); is saved relatively to 127, i.e. the current value of the exponent is calculated by subtracting the number 127 from the saved value. Curr. exp. = saved exp value. -- 127 => range of numbers from 128 to -127!

Example 1: -12.5 decimal = 0xC1480000 hex

M: 24 bit-mantissa

E: Exponent with offset of 127

S: Sign for mantissa (S=1 neg.; S=0 pos.)

Address	+0	+1	+2	+3
Format	SEEEEEEE	EMMMMMMM	MMMMMMMM	MMMMMMMM
Binary	11000001	01001000	00000000	00000000

Hex	C1	48	00	00
-----	----	----	----	----

The byte sequence is defined as follows:

The byte with the "S sign bit" is transmitted over the bus as the first byte.

The sequence of the float bytes of the bus can be reversed, if necessary, using the device parameter 0xD02C (see table 1).

The register value 0xD02C in this case means:

- with 1 -> sign bit S in 1st byte (sequence according to definition)
- with 0 -> sign bit S in 4th byte (sequence reversed)

The following information can be derived from this:

The sign bit is 1 => negative mantissa

The value of the exponent amounts to 10000010 bin or 132 dec.

This results in an exponent value of: $130 - 127 = 3$

The mantissa has the following value: 10010000000000000000

The decimal point can be found at the left end of the mantissa, preceded by a 1. This position does not appear in the hexadecimal numeric notation. If you add 1 and set the decimal point at the beginning of the mantissa, the following value is obtained:

1.100100000000000000000000

Now, the mantissa needs to be adjusted to the exponent. A negative exponent shifts the decimal point to the left, a positive exponent shifts it to the right. Since the exponent is 3, this is represented as:

1100.10000000000000000000

The number obtained corresponds to the binary floating-point number.

Binary digits to the left of the decimal point result in values > 1. In this example, 1100 bin results in the number 12 dec. $\{(1 \times 2^3) + (1 \times 2^2) + (0 \times 2^1) + (0 \times 2^0)\}$

Binary digits to the right of the decimal point result in values < 1. In this example, .100..... bin results in the number 0.5 dec. $\{(1 \times 2^{-1}) + (0 \times 2^{-2}) + (0 \times 2^{-3}) + (0 \times 2^{-4})\}$

By adding the individual values, 12.5 is obtained. As the sign bit was set, it is a negative value, -12.5.

The hexadecimal number 0xC1480000 thus corresponds to -12.5.

Example 2: -12.55155 decimal = 0xC148D325 hex

Address	+0	+1	+2	+3
Format	SEEEEEEE	EMMMMMMMM	MMMMMMMMMM	MMMMMMMMMM
Binary	1 1 0 0 0 0 0 1	0 1 0 0 1 0 0 0	1 1 0 1 0 0 1 1	0 0 1 0 0 1 0 1
Hex	C1	48	D3	25

Example 3: 45.354 decimal = 0x42356A7F hex

Address	+0	+1	+2	+3
Format	SEEEEEEE	EMMMMMMMM	MMMMMMMMMM	MMMMMMMMMM
Binary	0 1 0 0 0 0 1 0	0 0 1 1 0 1 0 1	0 1 1 0 1 0 1 0	0 1 1 1 1 1 1 1
Hex	42	35	6A	7F

Exponent: 10000100 bin = 132 dec.

> Exp. = $132 - 127 = 5$

Mantissa: S=0

> Sign=positive

0110101011010100111111 bin

Decimal point added to the first position of the mantissa

> . 0110101011010100111111

Leading 1 in front of decimal point

> 1. 0110101011010100111111

Taking exponent into account (=5)

> 101101. 0101010100111111

To the left of the decimal point: $101101 \text{ bin} = 2^5 + 2^3 + 2^2 + 2^0 = 45 \text{ dec.}$

To the right of the decimal point: $0101010100111111 \text{ bin} = 2^{-2} + 2^{-4} + 2^{-5} + 2^{-7} + 2^{-9} + 2^{-12} + 2^{-13} + 2^{-14} + 2^{-15} + 2^{-16} + 2^{-17} + 2^{-18} = 0.3540001 \text{ dec.}$

Final result: +45.03540001 dec.

Timestamp time_t (is transmitted as unsigned long)

The timestamp describes a point in time. The value is defined as follows:

Seconds since 1/1/1970 0⁰⁰ hours (with respect to the corresponding time zone)

The values are transmitted over the bus as unsigned long (for byte sequence, see above). All values are to be interpreted as standard time (winter time), i.e. if you want to set the device clock in Germany to 11 o'clock in May, then the setting command via the bus must be done, by definition, with winter time 10 o'clock.

The following applies:

All timestamps which are transmitted via the bus are to be interpreted as standard time (winter time).

The device itself must be parametrized according to country-specific parameters.

Possible settings here:

e.g. in Germany -> daylight saving time from end of March to end of October

e.g. China -> daylight saving time not activated

3 Interface parameters

Setting options for Modbus RTU

Baud rate (Baud)	Parity	Data bits	Stop bits
4800, 9600, 19200	even, odd, none	8	2 for parity none otherwise 1

Setting options for Modbus ASCII

Baud rate (baud)	Parity	Data bits	Stop bits
4800, 9600, 19200	even, odd, none	7	2 for parity none otherwise 1

The number of data bits and stop bits is defined in the Modbus definition.

Baud rates of less than 4800 baud are possible by definition, but not implemented at present.

The interface parameters can only be set on the device. (not via the bus).

4 Device settings

Device settings are performed via the Modbus command 0x10 (Write Multiple Registers) in accordance with table 1.

These settings can also be read with the Modbus command 0x04

(in accordance with the Modbus definition, the required address must be set to -1 in the request telex).

Address	Words	Description	Values need to be converted to hexadecimal	Format
0xD002	2	Measuring voltage primary transformer	1-1000000	unsigned long
0xD004	2	Measuring voltage secondary transformer	1-600	unsigned long
0xD006	2	Measuring current primary transformer	1-1000000	unsigned long
0xD008	2	Measuring current secondary transformer	1 ->1A 5 ->5A	unsigned long
0xD00A	2	Frequency correction	0 automatic 1 50Hz fixed 2 60Hz fixed	unsigned long
0xD00C	2	Average current value, Averaging time in min	0-255	unsigned long
0xD00E	2	Attenuation voltage (0-9)	0-6	unsigned long
0xD010	2	Attenuation current (0-9)	0-6	unsigned long
0xD012	2	Synchronization type	0 only by internal clock. 1 by external synchronized pulse 2 by bus 3 by tariff change	unsigned long
0xD014	2	Tariff switching	0 by digital input 1 takes place through bus 2 takes place in device saved times	unsigned long
0xD016	2	Switch on low tariff clock time (in minutes per day)	0 to 1440	unsigned long
0xD018	2	Switch off low tariff clock time (in minutes per day)	0 to 1440	unsigned long
0xD01A	2	0 daylight saving time not active 1 daylight saving time active	0.1	unsigned long
0xD01C	2	Switch standard time → daylight saving time	1 – 12	unsigned long
0xD01E	2	Switch daylight saving time → standard time	1 – 12	unsigned long
0xD020	2	Continuous counter Set active energy HT	New value	float
0xD022	2	Continuous counter Set active energy LT	New value	float
0xD024	2	Continuous counter Set reactive energy HT	New value	float
0xD026	2	Continuous counter Set reactive energy LT	New value	float
0xD028	2	Set time	Time as timestamp	unsigned long

0xD02A	2	Factor for default Response times	Default setting 10 corresponds to factor 1.0 Factor 1.0 corresponds to >3.5 byte times Factor 2.0 corresponds to >7 byte times 0–255 i.e. factors 0 to 25.5	unsigned long
0xD02C	2	Byte sequence for float on the Modbus	1 according to definition 0 reversed	unsigned long
0xD02E	2	Energy form for synchronized pulse or tariff switching	0-63	unsigned long
0xD030	2	Pulse output pulse type	0 proportional to active energy consumption 1 proportional to reactive energy consumption 2 proportional to active energy recovery 3 proportional to reactive energy recovery	unsigned long
0xD032	2	Pulse output - pulse value	1 to 999,999 pulses/kW	float
0xD034	2	Pulse length in ms	30-990 ms in steps of 10	unsigned long
0xD036	2	ON delay relay 1 in s	0-255	unsigned long
0xD038	2	OFF delay relay 1 in s	0-255	unsigned long
0xD03A	2	ON delay relay 2 in s	0-255	unsigned long
0xD03C	2	OFF delay relay 2 in s	0-255	unsigned long
0xD03E	2	Analog interface TYPE	0 corresponds to 0–20 mA 1 corresponds to 4–20 mA 2 corresponds to 0–10 V 3 corresponds to 2–10 V	unsigned long
0xD040	2	Analog interface 1 measured value	ID according to table	unsigned long
0xD042	2	Analog interface 1 maximum value	Maximum value corresponds to this value	float
0xD044	2	Analog interface 1 minimum value	Minimum value corresponds to this value	float
0xD046	2	Analog interface 2 measured value	ID according to table	unsigned long
0xD048	2	Analog interface 2 maximum value	Maximum value corresponds to this value	float
0xD04A	2	Analog interface 2 minimum value	Minimum value corresponds to this value	float
0xD04C	2	Analog interface 3 measured value	ID according to table	unsigned long
0xD04E	2	Analog interface 3 maximum value	Maximum value corresponds to this value	float
0xD050	2	Analog interface 3 minimum value	Minimum value corresponds to this value	float
0xD052	2	Set continuous counteractive energy HT recovery	New value	float
0xD054	2	Set continuous counteractive energy LT recovery	New value	float
0xD056	2	Set continuous counter reactive energy HT recovery	New value	float
0xD058	2	Set continuous counter reactive energy LT recovery	New value	float

0xD05A	2	Rated voltage (Ph-N) for voltage monitoring	1 .. 1000000	float
0xD05C	2	Limit [0.01%] voltage dip	1 .. 10000	unsigned long
0xD05E	2	Hysteresis [0.01%] voltage dip	1 .. 10000	unsigned long
0xD060	2	Limit [0.01%] voltage overshoot	1 .. 10000	unsigned long
0xD062	2	Hysteresis [0.01%] voltage overshoot	1 .. 10000	unsigned long
0xD064	2	Limit [0.01%] voltage interruption	1 .. 10000	unsigned long
0xD066	2	Hysteresis [0.01%] voltage interruption	1 .. 10000	unsigned long
0xD068	2	Options for measured value recording	Bit0: Reactive energy with harmonics Bit1: Measure neutral conductor current Bit2: Log raw data for voltage dip Bit3: Log raw data for voltage overshoot Bit4: Trigger logging once Bit5..Bit31: Free	unsigned long
0xD06A	2	-	-	-
0xD06C	2	-	-	-
0xD06E	2	4. Primary current transformer (neutral conductor current)	1-1000000 A	unsigned long
0xD070	2	4. Secondary current transformer (neutral conductor current)	1 ->1A 5 ->5A	unsigned long

Table 1

The following table describes the IDs that are used to configure the analog interfaces. The value output is proportional to the measured value selected.

Value output	ID
OFF	0
U_PH_N_L1_V	1
U_PH_N_L2_V	2
U_PH_N_L3_V	3
U_PH_PH_L1_L2_V	4
U_PH_PH_L2_L3_V	5
U_PH_PH_L3_L1_V	6
IS_L1_A	7
IS_L2_A	8
IS_L3_A	9
IS_MW_L1_A	10
IS_MW_L2_A	11
IS_MW_L3_A	12
S_L1_VA	13
S_L2_VA	14
S_L3_VA	15
P_L1_VA	16
P_L2_VA	17
P_L3_VA	18
Q1_L1_VAR	19
Q1_L2_VAR	20
Q1_L3_VAR	21
COS_L1	22
COS_L2	23
COS_L3	24
LF_L1	25
LF_L2	26
LF_L3	27
NETWORK FREQUEN	28
CY_HZ	
IN_A	29
IN_MW_A	30
S_GES_VA	31
P_GES_W	32
Q_GES_VAR	33
PF_TOT	34

Example Modbus RTU

Request:

01 10 D0 1F 00 02 04 42 C9 00 00 EB 60

in which

01	Device address
10	Command
D0 1F	Register 0xD020 continuous counteractive energy consumption HT (in accordance with Modbus definition, the required address must be set to -1 in the request telex)
00 02	Write 2 registers
04	Write 4 bytes
42 C9 00 00	Set to value 100.5
EB 60	CRC code

Response:

01 10 D0 1F 00 02 48 CE

in which

01	Device address
10	Command
D0 1F	Write from register 0xD0020
00 02	2 words written
48 CE	CRC code

Example Modbus ASCII

Request:

3A 30 31 31 30 44 30 30 31 30 30 30 34 30 38 30 30 30 30 31 39 30 30 30 30 30 31 39 30 46

30 0D 0A

in which

3A	Start telex (colon)
30 31	Device address 0x01
31 30	Command 0x10
44 30 30 31	Set registers 0xD002 to 0xD005 (in accordance with the Modbus definition, the required address must be set to -1 in the request telex)
30 30 30 34	Set 4 registers (primary voltage transformer 2 words and secondary 2 words)
30 38	Write number of bytes (8 bytes)
30 30 30 30 30 31 39 30	Primary voltage transformer 0x190 corresponds to dec. 400 V
30 30 30 30 30 31 39 30	Secondary voltage transformer 0x190 corresponds to dec. 400 V
46 30	LRC code
0D 0A	Telex end (CR LF)

Response:

3A 30 31 31 30 44 30 30 31 30 30 30 34 31 41 0D 0A

in which

3A	Start telex (colon)
30 31	Device address 0x01
31 30	Command 0x10
44 30 30 31	Registers 0xD002 to 0xD005 set
30 30 30 34	4 data bytes written
30 30 30 30	No limit violated with address 4 to 13
	Last 6 bits in byte 00 are without meaning
31 41	LRC code
0D 0A	Telex end (CR LF)

5 Commands

Commands can only be executed via the command 0x06 (Write Single Register) in accordance with table 2
(in accordance with the Modbus definition, the required address must be set to -1 in the request telex).

Address	Words	Description	Values need to be converted to hexadecimal	Format
0xF001	1	Device reset	42	unsigned short
0xF002	1	Reset all maximum values	0	unsigned short
0xF003	1	Reset all minimum values	0	unsigned short
0xF004	1	Tariff switching to HT	Energy type 0-63	unsigned short
0xF005	1	Tariff switching to LT	Energy type 0-63	unsigned short
0xF006	1	Delete error status	0	unsigned short
0xF007	1	Delete daily energy meter	0	unsigned short

Table 2

Example Modbus RTU

Request:

01 06 F0 05 00 00 AA CB

in which

01	Device address
06	Command
F0 05	Register 0xF006 delete error status (in accordance with Modbus definition, the required address must be set to -1 in the request telex)
00 00	Value 0 (in accordance with definition in table 2)
AA CB	CRC code

Response:

01 06 F0 05 00 00 AA CB

in which

01	Device address
06	Command
F0 05	Register 0xF006 delete error status (in accordance with Modbus definition, the required address must be set to -1 in the request telex)
00 00	Value 0 (in accordance with definition in table 2)
AA CB	CRC code

Example Modbus ASCII

Request:

3A 30 31 30 36 46 30 30 31 30 30 30 30 38 0D 0A

in which

3A	Start telex (colon)
30 31	Device address 0x01
30 36	Command 0x06
46 30 30 31	Command 0xF002 reset all maximum values (in accordance with the Modbus definition, the required address must be set to -1 in the request telex)
30 30 30 30	Value 0 (in accordance with definition in table 2)
30 38	LRC code
0D 0A	Telex end (CR LF)

Response:

3A 30 31 30 36 46 30 30 31 30 30 30 30 38 0D 0A

in which

3A	Start telex (colon)
30 31	Device address 0x01
30 36	Command 0x06
46 30 30 31	Command 0xF002 reset all maximum values (in accordance with the Modbus definition, the required address must be set to -1 in the request telex)
30 30 30 30	Value 0 (in accordance with definition in table 2)
30 38	LRC code
0D 0A	Telex end (CR LF)

6 Limit violations

Limit violations are read via the command 0x02 (Read Discrete Inputs) in accordance with table 3 (in accordance with the Modbus definition, the required address must be set to -1 in the request telex).

Table 3

Address	Description of limit violations
0x0001	1st limit voltage PH-N L1
0x0002	1st limit voltage PH-N L2
0x0003	1st limit voltage PH-N L3
0x0004	2nd limit voltage PH-N L1
0x0005	2nd limit voltage PH-N L2
0x0006	2nd limit voltage PH-N L3
0x0007	1st limit voltage PH-PH L1-L2
0x0008	1st limit voltage PH-PH L2-L3
0x0009	1st limit voltage PH-PH L3-L1
0x000a	2nd limit voltage PH-PH L1-L2
0x000b	2nd limit voltage PH-PH L2-L3
0x000c	2nd limit voltage PH-PH L3-L1
0x000d	1st limit current L1
0x000e	1st limit current L2
0x000f	1st limit current L3
0x0010	2nd limit current L1
0x0011	2nd limit current L2
0x0012	2nd limit current L3
0x0013	1st limit current average value L1
0x0014	1st limit current average value L2
0x0015	1st limit current average value L3

Address	Description of limit violations
0x0016	2nd limit current average value L1
0x0017	2nd limit current average value L2
0x0018	2nd limit current average value L3
0x0019	1st limit apparent power L1
0x001a	1st limit apparent power L2
0x001b	1st limit apparent power L3
0x001c	2nd limit apparent power L1
0x001d	2nd limit apparent power L2
0x001e	2nd limit apparent power L3
0x001f	1st limit active power L1
0x0020	1st limit active power L2
0x0021	1st limit active power L3
0x0022	2nd limit active power L1
0x0023	2nd limit active power L2
0x0024	2nd limit active power L3
0x0025	1st limit reactive power L1
0x0026	1st limit reactive power L2
0x0027	1st limit reactive power L3
0x0028	2nd limit reactive power L1
0x0029	2nd limit reactive power L2
0x002a	2nd limit reactive power L3
0x002b	1st limit cos Phi L1
0x002c	1st limit cos Phi L2
0x002d	1st limit cos Phi L3
0x002e	2nd limit cos Phi L1
0x002f	2nd limit cos Phi L2
0x0030	2nd limit cos Phi L3
0x0031	1st limit power factor L1
0x0032	1st limit power factor L2
0x0033	1st limit power factor L3
0x0034	2nd limit power factor L1
0x0035	2nd limit power factor L2
0x0036	2nd limit power factor L3
0x0037	1st limit voltage distortion factor L1
0x0038	1st limit voltage distortion factor L2
0x0039	1st limit voltage distortion factor L3
0x003a	2nd limit voltage distortion factor L1
0x003b	2nd limit voltage distortion factor L2
0x003c	2nd limit voltage distortion factor L3
0x003d	1st limit voltage 3rd harmonic L1
0x003e	1st limit voltage 3rd harmonic L2
0x003f	1st limit voltage 3rd harmonic L3
0x0040	2nd limit voltage 3rd harmonic L1
0x0041	2nd limit voltage 3rd harmonic L2
0x0042	2nd limit voltage 3rd harmonic L3
0x0043	1st limit voltage 5th harmonic L1
0x0044	1st limit voltage 5th harmonic L2
0x0045	1st limit voltage 5th harmonic L3
0x0046	2nd limit voltage 5th harmonic L1
0x0047	2nd limit voltage 5th harmonic L2
0x0048	2nd limit voltage 5th harmonic L3
0x0049	1st limit voltage 7th harmonic L1
0x004a	1st limit voltage 7th harmonic L2
0x004b	1st limit voltage 7th harmonic L3

Address	Description of limit violations
0x004c	2nd limit voltage 7th harmonic L1
0x004d	2nd limit voltage 7th harmonic L2
0x004e	2nd limit voltage 7th harmonic L3
0x004f	1st limit voltage 9th harmonic L1
0x0050	1st limit voltage 9th harmonic L2
0x0051	1st limit voltage 9th harmonic L3
0x0052	2nd limit voltage 9th harmonic L1
0x0053	2nd limit voltage 9th harmonic L2
0x0054	2nd limit voltage 9th harmonic L3
0x0055	1st limit voltage 11th harmonic L1
0x0056	1st limit voltage 11th harmonic L2
0x0057	1st limit voltage 11th harmonic L3
0x0058	2nd limit voltage 11th harmonic L1
0x0059	2nd limit voltage 11th harmonic L2
0x005a	2nd limit voltage 11th harmonic L3
0x005b	1st limit voltage 13th harmonic L1
0x005c	1st limit voltage 13th harmonic L2
0x005d	1st limit voltage 13th harmonic L3
0x005e	2nd limit voltage 13th harmonic L1
0x005f	2nd limit voltage 13th harmonic L2
0x0060	2nd limit voltage 13th harmonic L3
0x0061	1st limit total harmonic currents L1
0x0062	1st limit total harmonic currents L2
0x0063	1st limit total harmonic currents L3
0x0064	2nd limit total harmonic currents L1
0x0065	2nd limit total harmonic currents L2
0x0066	2nd limit total harmonic currents L3
0x0067	1st limit current 3rd harmonic L1
0x0068	1st limit current 3rd harmonic L2
0x0069	1st limit current 3rd harmonic L3
0x006a	2nd limit current 3rd harmonic L1
0x006b	2nd limit current 3rd harmonic L2
0x006c	2nd limit current 3rd harmonic L3
0x006d	1st limit current 5th harmonic L1
0x006e	1st limit current 5th harmonic L2
0x006f	1st limit current 5th harmonic L3
0x0070	2nd limit current 5th harmonic L1
0x0071	2nd limit current 5th harmonic L2
0x0072	2nd limit current 5th harmonic L3
0x0073	1st limit current 7th harmonic L1
0x0074	1st limit current 7th harmonic L2
0x0075	1st limit current 7th harmonic L3
0x0076	2nd limit current 7th harmonic L1
0x0077	2nd limit current 7th harmonic L2
0x0078	2nd limit current 7th harmonic L3
0x0079	1st limit current 9th harmonic L1
0x007a	1st limit current 9th harmonic L2
0x007b	1st limit current 9th harmonic L3
0x007c	2nd limit current 9th harmonic L1
0x007d	2nd limit current 9th harmonic L2
0x007e	2nd limit current 9th harmonic L3
0x007f	1st limit current 11th harmonic L1
0x0080	1st limit current 11th harmonic L2
0x0081	1st limit current 11th harmonic L3

Address	Description of limit violations
0x0082	2nd limit current 11th harmonic L1
0x0083	2nd limit current 11th harmonic L2
0x0084	2nd limit current 11th harmonic L3
0x0085	1st limit current 13th harmonic L1
0x0086	1st limit current 13th harmonic L2
0x0087	1st limit current 13th harmonic L3
0x0088	2nd limit current 13th harmonic L1
0x0089	2nd limit current 13th harmonic L2
0x008a	2nd limit current 13th harmonic L3
0x008b	1st limit network frequency
0x008c	2nd limit network frequency
0x008d	1st limit neutral conductor current
0x008e	2nd limit neutral conductor current
0x008f	1st limit average value neutral conductor current
0x0090	2nd limit average value neutral conductor current
0x0091	1st limit total active power
0x0092	2nd limit total active power
0x0093	1st limit total reactive power
0x0094	2nd limit total reactive power
0x0095	1st limit total apparent power
0x0096	2nd limit total apparent power
0x0097	1st limit power factor
0x0098	2nd limit power factor
0x0099	1st limit current PE
0x009A	2nd limit current PE

Table 3

Example Modbus RTU

Request:

01 02 00 00 00 07 79 CC

in which

01	Device address
02	Command
00 00	Address 1st limit U-PhN L1 (in accordance with the Modbus definition, the required address must be set to -1 in the request telex)
00 07	Number of addresses to be evaluated (addresses 1 to 7)
79 CC	CRC code

Response:

01 02 01 07 E0 4A

in which

01	Device address
02	Command
01	Number of data bytes
07	1st limit U-PhN-L1 violated 1st limit U-PhN-L2 violated 1st limit U-PhN-L3 violated 2nd limit U-PhN-L1 not violated 2nd limit U-PhN-L2 not violated 2nd limit U-PhN-L3 not violated 1st limit U-PhPh L1 not violated Last bit in byte is without meaning
E0 4A	CRC code

Example Modbus ASCII

Request:

3A 30 31 30 32 30 30 33 30 30 41 46 30 0D 0A

in which

3A	Start telex (colon)
30 31	Device address 0x01
30 32	Command 0x02
30 30 30 33	Address 4th limit U-PhPh L1 (in accordance with the Modbus definition, the required address must be set to -1 in the request telex)
30 30 30 41	Number of addresses to be evaluated 0x0A
46 30	LRC code
0D 0A	Telex end (CR LF)

Response:

3A 30 31 30 32 30 32 30 30 30 46 42 0D 0A

in which

3A	Start telex (colon)
30 31	Device address 0x01
30 32	Command
30 32	Number of data bytes 0x02
30 30 30 30	No limit violated with address 4 to 13
	Last 6 bits in byte 00 are without meaning
46 42	LRC code
0D 0A	Telex end (CR LF)

7 Data points

Data points are read via the command 0x04 (Read Input Registers) in accordance with table 4 (in accordance with the Modbus definition, the required address must be set to -1 in the request telex).

Table 4

Address	Words	Description	Unit	Format
0x0002	2	Voltage PH-N L1	V	float
0x0004	2	Voltage PH-N L2	V	float
0x0006	2	Voltage PH-N L3	V	float
0x0008	2	Voltage PH-PH L1-L2	V	float
0x000a	2	Voltage PH-PH L2-L3	V	float
0x000c	2	Voltage PH-PH L3-L1	V	float
0x000e	2	Current L1	A	float
0x0010	2	Current L2	A	float
0x0012	2	Current L3	A	float
0x0014	2	Current average value L1	A	float
0x0016	2	Current average value L2	A	float
0x0018	2	Current average value L3	A	float
0x001a	2	Apparent power L1	VA	float
0x001c	2	Apparent power L2	VA	float
0x001e	2	Apparent power L3	VA	float
0x0020	2	Active power L1	W	float
0x0022	2	Active power L2	W	float
0x0024	2	Active power L3	W	float
0x0026	2	Fundamental reactive power L1	var	float
0x0028	2	Fundamental reactive power L2	var	float
0x002a	2	Fundamental reactive power L3	var	float

Address	Words	Description	Unit	Format
0x002c	2	cos Phi L1		float
0x002e	2	cos Phi L2		float
0x0030	2	cos Phi L3		float
0x0032	2	Power factor L1		float
0x0034	2	Power factor L2		float
0x0036	2	Power factor L3		float
0x0038	2	Voltage distortion factor L1	%	float
0x003a	2	Voltage distortion factor L2	%	float
0x003c	2	Voltage distortion factor L3	%	float
0x003e	2	Voltage 3rd harmonic L1	%	float
0x0040	2	Voltage 3rd harmonic L2	%	float
0x0042	2	Voltage 3rd harmonic L3	%	float
0x0044	2	Voltage 5th harmonic L1	%	float
0x0046	2	Voltage 5th harmonic L2	%	float
0x0048	2	Voltage 5th harmonic L3	%	float
0x004a	2	Voltage 7th harmonic L1	%	float
0x004c	2	Voltage 7th harmonic L2	%	float
0x004e	2	Voltage 7th harmonic L3	%	float
0x0050	2	Voltage 9th harmonic L1	%	float
0x0052	2	Voltage 9th harmonic L2	%	float
0x0054	2	Voltage 9th harmonic L3	%	float
0x0056	2	Voltage 11th harmonic L1	%	float
0x0058	2	Voltage 11th harmonic L2	%	float
0x005a	2	Voltage 11th harmonic L3	%	float
0x005c	2	Voltage 13th harmonic L1	%	float
0x005e	2	Voltage 13th harmonic L2	%	float
0x0060	2	Voltage 13th harmonic L3	%	float
0x0062	2	Voltage 15th harmonic L1	%	float
0x0064	2	Voltage 15th harmonic L2	%	float
0x0066	2	Voltage 15th harmonic L3	%	float
0x0068	2	Voltage 17th harmonic L1	%	float
0x006a	2	Voltage 17th harmonic L2	%	float
0x006c	2	Voltage 17th harmonic L3	%	float
0x006e	2	Voltage 19th harmonic L1	%	float
0x0070	2	Voltage 19th harmonic L2	%	float
0x0072	2	Voltage 19th harmonic L3	%	float
0x0074	2	Total harmonic currents L1	A	float
0x0076	2	Total harmonic currents L2	A	float
0x0078	2	Total harmonic currents L3	A	float
0x007a	2	Current 3rd harmonic L1	A	float
0x007c	2	Current 3rd harmonic L2	A	float
0x007e	2	Current 3rd harmonic L3	A	float
0x0080	2	Current 5th harmonic L1	A	float
0x0082	2	Current 5th harmonic L2	A	float
0x0084	2	Current 5th harmonic L3	A	float
0x0086	2	Current 7th harmonic L1	A	float
0x0088	2	Current 7th harmonic L2	A	float
0x008a	2	Current 7th harmonic L3	A	float
0x008c	2	Current 9th harmonic L1	A	float
0x008e	2	Current 9th harmonic L2	A	float
0x0090	2	Current 9th harmonic L3	A	float
0x0092	2	Current 11th harmonic L1	A	float
0x0094	2	Current 11th harmonic L2	A	float
0x0096	2	Current 11th harmonic L3	A	float

Address	Words	Description	Unit	Format
0x0098	2	Current 13th harmonic L1	A	float
0x009a	2	Current 13th harmonic L2	A	float
0x009c	2	Current 13th harmonic L3	A	float
0x009e	2	Current 15th harmonic L1	A	float
0x00a0	2	Current 15th harmonic L2	A	float
0x00a2	2	Current 15th harmonic L3	A	float
0x00a4	2	Current 17th harmonic L1	A	float
0x00a6	2	Current 17th harmonic L2	A	float
0x00a8	2	Current 17th harmonic L3	A	float
0x00aa	2	Current 19th harmonic L1	A	float
0x00ac	2	Current 19th harmonic L2	A	float
0x00ae	2	Current 19th harmonic L3	A	float
0x00b0	2	Network frequency	Hz	float
0x00b2	2	Neutral conductor current	A	float
0x00b4	2	Average value neutral conductor current	A	float
0x00b6	2	Total active power	W	float
0x00b8	2	Total fundamental reactive power	var	float
0x00ba	2	Total apparent power	VA	float
0x00bc	2	Power factor		float
0x00be	2	Condition relay 1		unsigned long
0x00c0	2	Condition relay 2		unsigned long
0x00c2	2	Error state		unsigned long
0x00c4	2	Time		unsigned long
0x00c6	2	Maximum: Voltage PH-N L1	V	float
0x00c8	2	Maximum: Voltage PH-N L2	V	float
0x00ca	2	Maximum: Voltage PH-N L3	V	float
0x00cc	2	Maximum: Voltage PH-PH L1-L2	V	float
0x00ce	2	Maximum: Voltage PH-PH L2-L3	V	float
0x00d0	2	Maximum: Voltage PH-PH L3-L1	V	float
0x00d2	2	Maximum: Current L1	A	float
0x00d4	2	Maximum: Current L2	A	float
0x00d6	2	Maximum: Current L3	A	float
0x00d8	2	Maximum: Current average value L1	A	float
0x00da	2	Maximum: Current average value L2	A	float
0x00dc	2	Maximum: Current average value L3	A	float
0x00de	2	Maximum: Apparent power L1	VA	float
0x00e0	2	Maximum: Apparent power L2	VA	float
0x00e2	2	Maximum: Apparent power L3	VA	float
0x00e4	2	Maximum: Active power L1	W	float
0x00e6	2	Maximum: Active power L2	W	float
0x00e8	2	Maximum: Active power L3	W	float
0x00ea	2	Maximum: Fundamental reactive power L1	var	float
0x00ec	2	Maximum: Fundamental reactive power L2	var	float
0x00ee	2	Maximum: Fundamental reactive power L3	var	float
0x00f0	2	Maximum: cos Phi L1		float
0x00f2	2	Maximum: cos Phi L2		float
0x00f4	2	Maximum: cos Phi L3		float
0x00f6	2	Maximum: Power factor L1		float
0x00f8	2	Maximum: Power factor L2		float
0x00fa	2	Maximum: Power factor L3		float
0x00fc	2	Maximum: Voltage distortion factor L1	%	float
0x00fe	2	Maximum: Voltage distortion factor L2	%	float
0x0100	2	Maximum: Voltage distortion factor L3	%	float
0x0102	2	Maximum: Voltage 3rd harmonic L1	%	float

Address	Words	Description	Unit	Format
0x0104	2	Maximum: Voltage 3rd harmonic L2	%	float
0x0106	2	Maximum: Voltage 3rd harmonic L3	%	float
0x0108	2	Maximum: Voltage 5th harmonic L1	%	float
0x010a	2	Maximum: Voltage 5th harmonic L2	%	float
0x010c	2	Maximum: Voltage 5th harmonic L3	%	float
0x010e	2	Maximum: Voltage 7th harmonic L1	%	float
0x0110	2	Maximum: Voltage 7th harmonic L2	%	float
0x0112	2	Maximum: Voltage 7th harmonic L3	%	float
0x0114	2	Maximum: Voltage 9th harmonic L1	%	float
0x0116	2	Maximum: Voltage 9th harmonic L2	%	float
0x0118	2	Maximum: Voltage 9th harmonic L3	%	float
0x011a	2	Maximum: Voltage 11th harmonic L1	%	float
0x011c	2	Maximum: Voltage 11th harmonic L2	%	float
0x011e	2	Maximum: Voltage 11th harmonic L3	%	float
0x0120	2	Maximum: Voltage 13th harmonic L1	%	float
0x0122	2	Maximum: Voltage 13th harmonic L2	%	float
0x0124	2	Maximum: Voltage 13th harmonic L3	%	float
0x0126	2	Maximum: Voltage 15th harmonic L1	%	float
0x0128	2	Maximum: Voltage 15th harmonic L2	%	float
0x012a	2	Maximum: Voltage 15th harmonic L3	%	float
0x012c	2	Maximum: Voltage 17th harmonic L1	%	float
0x012e	2	Maximum: Voltage 17th harmonic L2	%	float
0x0130	2	Maximum: Voltage 17th harmonic L3	%	float
0x0132	2	Maximum: Voltage 19th harmonic L1	%	float
0x0134	2	Maximum: Voltage 19th harmonic L2	%	float
0x0136	2	Maximum: Voltage 19th harmonic L3	%	float
0x0138	2	Maximum: Total harmonic currents L1	A	float
0x013a	2	Maximum: Total harmonic currents L2	A	float
0x013c	2	Maximum: Total harmonic currents L3	A	float
0x013e	2	Maximum: Current 3rd harmonic L1	A	float
0x0140	2	Maximum: Current 3rd harmonic L2	A	float
0x0142	2	Maximum: Current 3rd harmonic L3	A	float
0x0144	2	Maximum: Current 5th harmonic L1	A	float
0x0146	2	Maximum: Current 5th harmonic L2	A	float
0x0148	2	Maximum: Current 5th harmonic L3	A	float
0x014a	2	Maximum: Current 7th harmonic L1	A	float
0x014c	2	Maximum: Current 7th harmonic L2	A	float
0x014e	2	Maximum: Current 7th harmonic L3	A	float
0x0150	2	Maximum: Current 9th harmonic L1	A	float
0x0152	2	Maximum: Current 9th harmonic L2	A	float
0x0154	2	Maximum: Current 9th harmonic L3	A	float
0x0156	2	Maximum: Current 11th harmonic L1	A	float
0x0158	2	Maximum: Current 11th harmonic L2	A	float
0x015a	2	Maximum: Current 11th harmonic L3	A	float
0x015c	2	Maximum: Current 13th harmonic L1	A	float
0x015e	2	Maximum: Current 13th harmonic L2	A	float
0x0160	2	Maximum: Current 13th harmonic L3	A	float
0x0162	2	Maximum: Current 15th harmonic L1	A	float
0x0164	2	Maximum: Current 15th harmonic L2	A	float
0x0166	2	Maximum: Current 15th harmonic L3	A	float
0x0168	2	Maximum: Current 17th harmonic L1	A	float
0x016a	2	Maximum: Current 17th harmonic L2	A	float
0x016c	2	Maximum: Current 17th harmonic L3	A	float
0x016e	2	Maximum: Current 19th harmonic L1	A	float

Address	Words	Description	Unit	Format
0x0170	2	Maximum: Current 19th harmonic L2	A	float
0x0172	2	Maximum: Current 19th harmonic L3	A	float
0x0174	2	Maximum: Network frequency	Hz	float
0x0176	2	Maximum: Neutral conductor current	A	float
0x0178	2	Maximum: Average value neutral conductor current	A	float
0x017a	2	Maximum: Total active power	W	float
0x017c	2	Maximum: Total fundamental reactive power	var	float
0x017e	2	Maximum: Total apparent power	VA	float
0x0180	2	Maximum: Power factor		float
0x0182	2	Minimum: Voltage PH-N L1	V	float
0x0184	2	Minimum: Voltage PH-N L2	V	float
0x0186	2	Minimum: Voltage PH-N L3	V	float
0x0188	2	Minimum: Voltage PH-PH L1-L2	V	float
0x018a	2	Minimum: Voltage PH-PH L2-L3	V	float
0x018c	2	Minimum: Voltage PH-PH L3-L1	V	float
0x018e	2	Minimum: Current L1	A	float
0x0190	2	Minimum: Current L2	A	float
0x0192	2	Minimum: Current L3	A	float
0x0194	2	Minimum: Current average value L1	A	float
0x0196	2	Minimum: Current average value L2	A	float
0x0198	2	Minimum: Current average value L3	A	float
0x019a	2	Minimum: Apparent power L1	VA	float
0x019c	2	Minimum: Apparent power L2	VA	float
0x019e	2	Minimum: Apparent power L3	VA	float
0x01a0	2	Minimum: Active power L1	W	float
0x01a2	2	Minimum: Active power L2	W	float
0x01a4	2	Minimum: Active power L3	W	float
0x01a6	2	Minimum: Fundamental reactive power L1	var	float
0x01a8	2	Minimum: Fundamental reactive power L2	var	float
0x01aa	2	Minimum: Fundamental reactive power L3	var	float
0x01ac	2	Minimum: cos Phi L1		float
0x01ae	2	Minimum: cos Phi L2		float
0x01b0	2	Minimum: cos Phi L3		float
0x01b2	2	Minimum: Power factor L1		float
0x01b4	2	Minimum: Power factor L2		float
0x01b6	2	Minimum: Power factor L3		float
0x01b8	2	Minimum: Network frequency	Hz	float
0x01ba	2	Minimum: Neutral conductor current	A	float
0x01bc	2	Minimum: Average value neutral conductor current	A	float
0x01be	2	Minimum: Total active power	W	float
0x01c0	2	Minimum: Total fundamental reactive power	var	float
0x01c2	2	Minimum: Total apparent power	VA	float
0x01c4	2	Minimum: Power factor		float
0x01c6	2	Maximum date: Voltage PH-N L1		unsigned long
0x01c8	2	Maximum date: Voltage PH-N L2		unsigned long
0x01ca	2	Maximum date: Voltage PH-N L3		unsigned long
0x01cc	2	Maximum date: Voltage PH-PH L1-L2		unsigned long
0x01ce	2	Maximum date: Voltage PH-PH L2-L3		unsigned long
0x01d0	2	Maximum date: Voltage PH-PH L3-L1		unsigned long
0x01d2	2	Maximum date: Current L1		unsigned long
0x01d4	2	Maximum date: Current L2		unsigned long
0x01d6	2	Maximum date: Current L3		unsigned long
0x01d8	2	Maximum date: Current average value L1		unsigned long
0x01da	2	Maximum date: Current average value L2		unsigned long

Address	Words	Description	Unit	Format
0x01dc	2	Maximum date: Current average value L3		unsigned long
0x01de	2	Maximum date: Apparent power L1		unsigned long
0x01e0	2	Maximum date: Apparent power L2		unsigned long
0x01e2	2	Maximum date: Apparent power L3		unsigned long
0x01e4	2	Maximum date: Active power L1		unsigned long
0x01e6	2	Maximum date: Active power L2		unsigned long
0x01e8	2	Maximum date: Active power L3		unsigned long
0x01ea	2	Maximum date: Fundamental reactive power L1		unsigned long
0x01ec	2	Maximum date: Fundamental reactive power L2		unsigned long
0x01ee	2	Maximum date: Fundamental reactive power L3		unsigned long
0x01f0	2	Maximum date: cos Phi L1		unsigned long
0x01f2	2	Maximum date: cos Phi L2		unsigned long
0x01f4	2	Maximum date: cos Phi L3		unsigned long
0x01f6	2	Maximum date: Power factor L1		unsigned long
0x01f8	2	Maximum date: Power factor L2		unsigned long
0x01fa	2	Maximum date: Power factor L3		unsigned long
0x01fc	2	Maximum date: Voltage distortion factor L1		unsigned long
0x01fe	2	Maximum date: Voltage distortion factor L2		unsigned long
0x0200	2	Maximum date: Voltage distortion factor L3		unsigned long
0x0202	2	Maximum date: Voltage 3rd harmonic L1		unsigned long
0x0204	2	Maximum date: Voltage 3rd harmonic L2		unsigned long
0x0206	2	Maximum date: Voltage 3rd harmonic L3		unsigned long
0x0208	2	Maximum date: Voltage 5th harmonic L1		unsigned long
0x020a	2	Maximum date: Voltage 5th harmonic L2		unsigned long
0x020c	2	Maximum date: Voltage 5th harmonic L3		unsigned long
0x020e	2	Maximum date: Voltage 7th harmonic L1		unsigned long
0x0210	2	Maximum date: Voltage 7th harmonic L2		unsigned long
0x0212	2	Maximum date: Voltage 7th harmonic L3		unsigned long
0x0214	2	Maximum date: Voltage 9th harmonic L1		unsigned long
0x0216	2	Maximum date: Voltage 9th harmonic L2		unsigned long
0x0218	2	Maximum date: Voltage 9th harmonic L3		unsigned long
0x021a	2	Maximum date: Voltage 11th harmonic L1		unsigned long
0x021c	2	Maximum date: Voltage 11th harmonic L2		unsigned long
0x021e	2	Maximum date: Voltage 11th harmonic L3		unsigned long
0x0220	2	Maximum date: Voltage 13th harmonic L1		unsigned long
0x0222	2	Maximum date: Voltage 13th harmonic L2		unsigned long
0x0224	2	Maximum date: Voltage 13th harmonic L3		unsigned long
0x0226	2	Maximum date: Voltage 15th harmonic L1		unsigned long
0x0228	2	Maximum date: Voltage 15th harmonic L2		unsigned long
0x022a	2	Maximum date: Voltage 15th harmonic L3		unsigned long
0x022c	2	Maximum date: Voltage 17th harmonic L1		unsigned long
0x022e	2	Maximum date: Voltage 17th harmonic L2		unsigned long
0x0230	2	Maximum date: Voltage 17th harmonic L3		unsigned long
0x0232	2	Maximum date: Voltage 19th harmonic L1		unsigned long
0x0234	2	Maximum date: Voltage 19th harmonic L2		unsigned long
0x0236	2	Maximum date: Voltage 19th harmonic L3		unsigned long
0x0238	2	Maximum date: Total harmonic currents L1		unsigned long
0x023a	2	Maximum date: Total harmonic currents L2		unsigned long
0x023c	2	Maximum date: Total harmonic currents L3		unsigned long
0x023e	2	Maximum date: Current 3rd harmonic L1		unsigned long
0x0240	2	Maximum date: Current 3rd harmonic L2		unsigned long
0x0242	2	Maximum date: Current 3rd harmonic L3		unsigned long
0x0244	2	Maximum date: Current 5th harmonic L1		unsigned long
0x0246	2	Maximum date: Current 5th harmonic L2		unsigned long

Address	Words	Description	Unit	Format
0x0248	2	Maximum date: Current 5th harmonic L3		unsigned long
0x024a	2	Maximum date: Current 7th harmonic L1		unsigned long
0x024c	2	Maximum date: Current 7th harmonic L2		unsigned long
0x024e	2	Maximum date: Current 7th harmonic L3		unsigned long
0x0250	2	Maximum date: Current 9th harmonic L1		unsigned long
0x0252	2	Maximum date: Current 9th harmonic L2		unsigned long
0x0254	2	Maximum date: Current 9th harmonic L3		unsigned long
0x0256	2	Maximum date: Current 11th harmonic L1		unsigned long
0x0258	2	Maximum date: Current 11th harmonic L2		unsigned long
0x025a	2	Maximum date: Current 11th harmonic L3		unsigned long
0x025c	2	Maximum date: Current 13th harmonic L1		unsigned long
0x025e	2	Maximum date: Current 13th harmonic L2		unsigned long
0x0260	2	Maximum date: Current 13th harmonic L3		unsigned long
0x0262	2	Maximum date: Current 15th harmonic L1		unsigned long
0x0264	2	Maximum date: Current 15th harmonic L2		unsigned long
0x0266	2	Maximum date: Current 15th harmonic L3		unsigned long
0x0268	2	Maximum date: Current 17th harmonic L1		unsigned long
0x026a	2	Maximum date: Current 17th harmonic L2		unsigned long
0x026c	2	Maximum date: Current 17th harmonic L3		unsigned long
0x026e	2	Maximum date: Current 19th harmonic L1		unsigned long
0x0270	2	Maximum date: Current 19th harmonic L2		unsigned long
0x0272	2	Maximum date: Current 19th harmonic L3		unsigned long
0x0274	2	Maximum date: Network frequency		unsigned long
0x0276	2	Maximum date: Neutral conductor current		unsigned long
0x0278	2	Maximum date: Average value neutral conductor current		unsigned long
0x027a	2	Maximum date: Total active power		unsigned long
0x027c	2	Maximum date: Total fundamental reactive power		unsigned long
0x027e	2	Maximum date: Total apparent power		unsigned long
0x0280	2	Maximum date: Power factor		unsigned long
0x0282	2	Minimum date: Voltage PH-N L1		unsigned long
0x0284	2	Minimum date: Voltage PH-N L2		unsigned long
0x0286	2	Minimum date: Voltage PH-N L3		unsigned long
0x0288	2	Minimum date: Voltage PH-PH L1-L2		unsigned long
0x028a	2	Minimum date: Voltage PH-PH L2-L3		unsigned long
0x028c	2	Minimum date: Voltage PH-PH L3-L1		unsigned long
0x028e	2	Minimum date: Current L1		unsigned long
0x0290	2	Minimum date: Current L2		unsigned long
0x0292	2	Minimum date: Current L3		unsigned long
0x0294	2	Minimum date: Current average value L1		unsigned long
0x0296	2	Minimum date: Current average value L2		unsigned long
0x0298	2	Minimum date: Current average value L3		unsigned long
0x029a	2	Minimum date: Apparent power L1		unsigned long
0x029c	2	Minimum date: Apparent power L2		unsigned long
0x029e	2	Minimum date: Apparent power L3		unsigned long
0x02a0	2	Minimum date: Active power L1		unsigned long
0x02a2	2	Minimum date: Active power L2		unsigned long
0x02a4	2	Minimum date: Active power L3		unsigned long
0x02a6	2	Minimum date: Reactive power L1		unsigned long
0x02a8	2	Minimum date: Reactive power L2		unsigned long
0x02aa	2	Minimum date: Reactive power L3		unsigned long
0x02ac	2	Maximum date: cos Phi L1		unsigned long
0x02ae	2	Maximum date: cos Phi L2		unsigned long
0x02b0	2	Maximum date: cos Phi L3		unsigned long
0x02b2	2	Minimum date: Power factor L1		unsigned long

Address	Words	Description	Unit	Format
0x02b4	2	Minimum date: Power factor L2		unsigned long
0x02b6	2	Minimum date: Power factor L3		unsigned long
0x02b8	2	Minimum date: Network frequency		unsigned long
0x02ba	2	Minimum date: Neutral conductor current		unsigned long
0x02bc	2	Minimum date: Average value neutral conductor current		unsigned long
0x02be	2	Minimum date: Total active power		unsigned long
0x02c0	2	Minimum date: Total reactive power		unsigned long
0x02c2	2	Minimum date: Total apparent power		unsigned long
0x02c4	2	Minimum date: Power factor		unsigned long
0x02c6	2	Active power meter reading (HT/consumption)	Wh	float
0x02c8	2	Active energy meter reading (LT/consumption)	Wh	float
0x02ca	2	Reactive energy meter reading (HT/consumption)	varh	float
0x02cc	2	Reactive energy meter reading (LT/consumption)	varh	float
0x02ce	2	Today: active energy HT consumption	Wh	float
0x02d0	2	Today: active energy LT consumption	Wh	float
0x02d2	2	Today: reactive energy HT consumption	varh	float
0x02d4	2	Today: reactive energy LT consumption	varh	float
0x02d6	2	Previous day: active energy HT consumption	Wh	float
0x02d8	2	Previous day: active energy LT consumption	Wh	float
0x02da	2	Previous day: reactive energy HT consumption	varh	float
0x02dc	2	Previous day: reactive energy LT consumption	varh	float
0x02de	2	Current month: active energy HT consumption	Wh	float
0x02e0	2	Current month: active energy LT consumption	Wh	float
0x02e2	2	Current month: reactive energy HT consumption	varh	float
0x02e4	2	Current month: reactive energy LT consumption	varh	float
0x02e6	2	Last month: active energy HT consumption	Wh	float
0x02e8	2	Last month: active energy LT consumption	Wh	float
0x02ea	2	Last month: reactive energy HT consumption	varh	float
0x02ec	2	Last month: reactive energy LT consumption	varh	float
0x02ee	2	Tariff index		unsigned long
0x02f0	2	Active energy meter reading (HT/recovery)	Wh	float
0x02f2	2	Active energy meter reading (LT/recovery)	Wh	float
0x02f4	2	Reactive energy meter reading (HT/recovery)	varh	float
0x02f6	2	Reactive energy meter reading (LT/recovery)	varh	float
0x02f8	2	Today: active energy HT recovery	Wh	float
0x02fa	2	Today: active energy LT recovery	Wh	float
0x02fc	2	Today: reactive energy HT recovery	varh	float
0x02fe	2	Today: reactive energy LT recovery	varh	float
0x0300	2	Previous day: active energy HT recovery	Wh	float
0x0302	2	Previous day: active energy LT recovery	Wh	float
0x0304	2	Previous day: reactive energy HT recovery	varh	float
0x0306	2	Previous day: reactive energy LT recovery	varh	float
0x0308	2	Current month: active energy HT recovery	Wh	float
0x030a	2	Current month: active energy LT recovery	Wh	float
0x030c	2	Current month: reactive energy HT recovery	varh	float
0x030e	2	Current month: reactive energy LT recovery	varh	float
0x0310	2	Last month: active energy HT recovery	Wh	float
0x0312	2	Last month: active energy LT recovery	Wh	float
0x0314	2	Last month: reactive energy HT recovery	varh	float
0x0316	2	Last month: reactive energy LT recovery	varh	float
0x0318	2	Status of digital inputs Bit 0: IN0 (sync input) (1 = active) Bit 1: IN1 (tariff input) (1 = active)	-	unsigned long
0x031a	2	Phase angle U L12	Degree	float

Address	Words	Description	Unit	Format
0x031c	2	Phase angle U L23	Degree	float
0x031e	2	Phase angle U L31	Degree	float
0x0320	2	Voltage asymmetry	%	float
0x0322	2	Harmonic total distortion U_L1 (THD)	%	float
0x0324	2	Harmonic total distortion U_L2 (THD)	%	float
0x0326	2	Harmonic total distortion U_L3 (THD)	%	float
0x0328	2	Harmonic total distortion I_L1 (THD)	%	float
0x032a	2	Harmonic total distortion I_L2 (THD)	%	float
0x032c	2	Harmonic total distortion I_L3 (THD)	%	float
0x032e	2	Harmonic subgroup total distortion U_L1 (THDS)	%	float
0x0330	2	Harmonic subgroup total distortion U_L2 (THDS)	%	float
0x0332	2	Harmonic subgroup total distortion U_L3 (THDS)	%	float
0x0334	2	Harmonic subgroup total distortion I_L1 (THDS)	%	float
0x0336	2	Harmonic subgroup total distortion I_L2 (THDS)	%	float
0x0338	2	Harmonic subgroup total distortion I_L3 (THDS)	%	float
0x033a	2	Total fundamental apparent power	VA	float
0x033c	2	Total reactive power	var	float
0x033e	2	Collective voltage PH-N	V	float
0x0340	2	Collective current L1..L3	A	float
0x0342	2	Fundamental apparent power L1	VA	float
0x0344	2	Fundamental apparent power L2	VA	float
0x0346	2	Fundamental apparent power L3	VA	float
0x0348	2	Total reactive power L1	var	float
0x034a	2	Total reactive power L2	var	float
0x034c	2	Total reactive power L3	var	float
0x034e	2	Collective apparent power	VA	float
0x0350	2	Collective reactive power	var	float
0x0352	2	Total power factor	%	float
0x0354	2	Frequency from FFT	Hz	float
0x0356	2	-	-	float
0x0358	2	Angle between U limit and I limit in degrees L1	Degree	float
0x035a	2	Angle between U limit and I limit in degrees L2	Degree	float
0x035c	2	Angle between U limit and I limit in degrees L3	Degree	float
0x035e	2	Collective fundamental apparent power	VA	float
0x0360	2	Collective fundamental active power	W	float
0x0362	2	Collective fundamental reactive power	var	float
0x0364	2	Fundamental voltage L1-N	V	float
0x0366	2	Fundamental voltage L2-N	V	float
0x0368	2	Fundamental voltage L3-N	V	float
0x036a	2	Harmonic voltage L1-N	V	float
0x036c	2	Harmonic voltage L2-N	V	float
0x036e	2	Harmonic voltage L3-N	V	float
0x0370	2	Fundamental current L1	A	float
0x0372	2	Fundamental current L2	A	float
0x0374	2	Fundamental current L3	A	float
0x0376	2	Harmonic current L1	A	float
0x0378	2	Harmonic current L2	A	float
0x037a	2	Harmonic current L3	A	float
0x1002	2	Last saved period value active power consumption	W	float
0x1004	2	Last saved period value reactive power consumption	var	float
0x1006	2	Last saved period value active power recovery	W	float
0x1008	2	Last saved period value reactive power recovery	var	float
0x100A	2	Timestamp of the period values last saved	s	unsigned long

Address	Words	Description	Unit	Format
0x100C	2	Instantaneous value of the current period active power consumption	W	float
0x100E	2	Instantaneous value of the current period reactive power consumption	var	float
0x1010	2	Instantaneous value of the current period active power recovery	W	float
0x1012	2	Instantaneous value of the current period reactive power recovery	var	float
0x1014	2	Remaining period time	s	unsigned long
0x1016	2	Period duration	min	unsigned long
0xE002	4	Active power meter reading (HT/consumption)	Wh	double
0xE006	4	Active energy meter reading (LT/consumption)	Wh	double
0xE00A	4	Reactive energy meter reading (HT/consumption)	varh	double
0xE00E	4	Reactive energy meter reading (LT/consumption)	varh	double
0xE012	4	Active energy meter reading (HT/recovery)	Wh	double
0xE016	4	Active energy meter reading (LT/recovery)	Wh	double
0xE01A	4	Reactive energy meter reading (HT/recovery)	varh	double
0xE01E	4	Reactive energy meter reading (LT/recovery)	varh	double

Table 4

Example Modbus ASCII

Request:

3A 30 31 30 34 30 31 31 31 30 30 30 32 45 37 0D 0A

in which

3A	Start telex (colon)
30 31	Device address 0x01
30 34	Command 0x40
30 31 31 31	Read from register 0x0112 (in accordance with the Modbus definition, the required address must be set to -1 in the request telex)
30 30 30 32	Read 2 registers, i.e. read 1 measured value (maximum: Voltage 7th harmonic L3)
45 37	LRC code
0D 0A	Telex end (CR LF)

Response:

3A 30 31 30 34 30 34 34 30 30 38 42 34 41 35 35 36 0D 0A

in which

3A	Start telex (colon)
30 31	Device address 0x01
30 34	Command 0x40
30 34	4 data bytes
34 30 30 38 42 34 41 35	Maximum: Voltage 7th harmonic L3 2.14%
35 36	LRC code
0D 0A	Telex end (CR LF)

Example Modbus RTU

Request:

01 04 00 1F 00 32 40 19

in which

01	Device address
04	Command
00 1F	Read active power L1 from register 0x0020 (in accordance with the Modbus definition, the required address must be set to -1 in the request telex)
00 32	Read 50 registers, i.e. read 25 data points
40 19	CRC code

Response:

01 04 64 40 DC E6 64 40 E0 04 82 40 DE 3A B9 BF D3 93 AA BF EC A4 F6 BF E1 4E A1 BF 75 D5
 91 BF 73 31 3C BF 74 6B 27 3E E5 63 6C 3E E5 63 6C 3E E5 63 6C 3F A8 F5 B7 3F 95 42 3D 3F A9
 37 D3 3D 47 37 08 3A 5B 37 38 3D 18 1C 8C 3F 9E CB 1C 3F 8A 47 2F 3F 9F 01 93 3E A6 01 35 3E
 9F 01 97 3E A7 86 3D 3E 9E CB 1C FE B3

in which

01	Device address	
04	Command	
64	100 data bytes	
40 DC E6 64	Active power L1	6.90 W
40 E0 04 82	Active power L2	7.00 W
40 DE 3A B9	Active power L3	6.94 W
BF D3 93 AA	Reactive power L1	-1.65 var
BF EC A4 F6	Reactive power L2	-1.85 var
BF E1 4E A1	Reactive power L3	-1.76 var
BF 75 D5 91	cos Phi L1	-0.96
BF 73 31 3C	cos Phi L2	-0.95
BF 74 6B 27	cos Phi L3	-0.95
3E E5 63 6C	Power factor L1	0.45
3E E5 63 6C	Power factor L2	0.45
3E E5 63 6C	Power factor L3	0.45
3F A8 F5 B7	Voltage distortion factor L1	1.32 %
3F 95 42 3D	Voltage distortion factor L2	1.17 %
3F A9 37 D3	Voltage distortion factor L3	1.32 %
3D 47 37 08	Voltage 3rd harmonic L1	0.05 %
3A 5B 37 38	Voltage 3rd harmonic L2	0.00 %
3D 18 1C 8C	Voltage 3rd harmonic L3	0.04 %
3F 9E CB 1C	Voltage 5th harmonic L1	1.24 %
3F 8A 47 2F	Voltage 5th harmonic L2	1.08 %
3F 9F 01 93	Voltage 5th harmonic L3	1.24 %
3E A6 01 35	Voltage 7th harmonic L1	0.32 %
3F 9F 01 97	Voltage 7th harmonic L2	0.31 %
3E A7 86 3D	Voltage 7th harmonic L3	0.33 %
3F 9E CB 1C	Voltage 9th harmonic L1	0.31 %
FE B3	CRC code	

8 Device information

The device information is read via the command 0x2B (Read Device Identification).

Information about the manufacturer, device code and device version is read in the process. The device supplies the "Basic Device Identification". "Regular" and "Extended Device Identification" are optional according to the Modbus definition. They are not used in the multimess F144.

Example Modbus RTU

Request:

01 2B 0E 01 00 70 77

in which

01	Device address
2B	Command
0E	MEI type according to the Modbus definition always 0x0E
01	Device ID code for "Basic Device Identification" (see Modbus definition)
00	Object ID -> in our example manufacturer name, product name and version
70 77	CRC code

Response:

05 2B 0E 01 01 00 00 03 00 08 4B 42 52 20 47 6D 62 48 01 14 6D 75 6C 74 69 6D 65 73 73 20 46 31 34 34 5F 35 20 20 20 02 09 20 35 2E 30 30 72 30 30 34

in which

05	Device address
2B	Command
0E	MEI type (see Modbus definition)
01	"Basic identification" (see Modbus definition)
01	"Conformity level" (see Modbus definition)
00	No further information follows (no additional telex required)
00	Next object ID
03	Number of objects
00	Object ID 00
08	Text length of ID 00
4B 42 52 20 47 6D 62 48	"KBR GmbH"
01	Object ID 01
14	Text length of ID 01
6D 75 6C 74 69 6D 65 73 73 20 46 31 34 34 5F 35 20 20 20	"multimess F144_5 "
02	Object ID 02
09	Text length of ID 02
20 35 2E 30 30 72 30 30 34	"5.00r004"
A7 A2	CRC code

Example Modbus ASCII

Request:

3A 30 31 32 42 30 45 30 31 30 32 43 33 0D 0A

in which

3A	Start telex (colon)
30 31	Device address 0x01
32 42	Command 0x2B
30 45	MEI type according to the Modbus definition always 0x0E
30 31	Device ID Code for "Basic Device Identification" (see Modbus definition)
30 32	Object ID -> in our example 02 read Version and Release
43 33	LRC code
0D 0A	Telex end (CR LF)

Response:

3A 30 35 32 42 30 45 30 31 30 31 30 30 30 32 30 31 30 32 30 39 32 30 33 35 32 45 33 30 33 30 37 32 33 30 33 30 33 34 43 39 0D 0A

in which

3A	Start telex (colon)
30 35	Device address 0x05
32 42	Command 0x2B
30 45	MEI type (see Modbus definition) 0E
30 31	"basic identification" (see Modbus definition) 01
30 31	"conformity level" (see Modbus definition) 01
30 30	No further information follows (no additional telex required) 00
30 32	Next object ID 02
30 31	Number of objects 01
30 32	Object ID 02
30 39	Text length of ID 02(09)
32 30 33 35 32 45 33 30 33 30 37 32 33 30 33 30 33 34	"5.00r004"
43 39	LRC code
0D 0A	Telex end (CR LF)



A series of 20 horizontal lines providing a space for handwritten notes.

24314_EDEBDA0263-1419-1_EN





A series of 20 horizontal lines for taking notes, evenly spaced down the page.

24315_EDEBDA0264-1419-1_EN



KBR Kompensationsanlagenbau GmbH

Am Kieferschlag 7
D-91126 Schwabach
Germany

T +49 (0) 9122 6373-0
F +49 (0) 9122 6373-83
E info@kbr.de

www.kbr.de