

Operating Manual

Network Analyzer multilog 3



multilog 3



Note:

Please note that this operating manual cannot describe the latest version of the device in all cases. For example, if you download a more recent firmware version from the internet, the following description may no longer be accurate in every point.

In this case, either contact us directly or refer to the most recent version of the operating manual, available on our website (www.kbr.de).

KBR GmbH

Am Kieferschlag 7
D-91126 Schwabach

Tel.: 09122 / 6373-0
Fax: 09122 / 6373-83

E-Mail info@kbr.de
Internet: www.kbr.de

KBR GmbH cannot be held liable for any damage or losses, resulting from printing errors or changes to this operating manual.

Furthermore, **KBR GmbH** does not assume responsibility for any damage or losses resulting from defective devices or from devices altered by the user.

Copyright 2024 by KBR GmbH

All rights reserved.

Table of Contents

1.	User Guidance	5
1.1	Target group.....	5
1.2	Warnings	5
1.3	Tips	5
1.4	Other Symbols.....	6
1.5	Applicable documentation	6
1.6	Keeping.....	6
1.7	Updated documentation	6
2.	Safety Instructions.....	7
2.1	Safety instructions.....	7
2.2	Meaning of the symbols used on the device.....	8
3.	Scope of Delivery/Order Codes multilog 3	9
3.1	Scope of Delivery.....	9
3.2	Order Codes	9
3.3	Technical data	11
4.	Accessories for current measurement	13
4.1.1	Rogowski current clamps	13
4.1.2	Current clamps	14
4.1.3	Accessories for current measurement	16
5.	Intended use	17
6.	Description.....	17
7.	Hardware multilog 3.....	18
7.1	multilog 3 Hardware.....	18
7.2	Accumulator	20
8.	Network connection multilog 3	21
8.1.1	Direct connection to a 3-phase low voltage network	21
8.2	Connection to a single-phase low voltage network	22
8.3	Connection to an isolated IT network	23
8.4	Connection to secondary transformer	24
8.5	Special circuit types	25
8.6	Starting a measurement.....	26
8.7	Memory management.....	26
8.8	Delete device memory	26
8.9	Storage requirements for measurement data.....	26
8.10	WLAN multilog 3	27

We take care of it

9.	multilog 3 App.....	28
9.1	Connection to multilog.....	28
10.	Maintenance/Cleaning.....	29
11.	Calibration	29
12.	Disposal	29
13.	Product Warranty.....	30

1 User Guidance



1.1 Target group

The User Manual is intended for skilled technicians as well trained and certified operators. The contents of this User Manual must be accessible to people tasked with the installation and operation of the system.

1.2 Warnings

Structure of the warnings

Warnings are structured as follows:

 SIGNAL WORD	Nature and source of the danger. Consequences of non-compliance.
	 Actions to avoid the danger.

Types of warnings

Warnings are distinguished by the type of danger they are warning against:

 DANGER!	Warns of imminent danger that can result in death or serious injuries if not avoided.
--	---

 WARNING!	Warns of a potentially dangerous situation that can result in death or serious injuries when not avoided.
---	---

 CAUTION!	Warns of a potentially dangerous situation that can result in fairly serious or minor injuries when not avoided.
---	--

NOTICE:	Warns of a potentially dangerous situation that if not avoided could result in material or environmental damage.
----------------	--

1.3 Tips



Tips on the appropriate device use and recommendations.

1.4 Other Symbols

Instructions

Structure of instructions:

 Guidance for an action.

→ Indication of an outcome, if necessary.

Lists

Structure of unnumbered lists:

- List level 1
 - List level 2

Structure of numbered lists:

- 1) List level 1
- 2) List level 1
 1. List level 2
 2. List level 2

1.5 Applicable documentation

For the safe and correct use of the product, observe the additional documentation that is delivered with the system as well as the relevant standards and laws.

1.6 Keeping















Keep the user manual, including the supplied documentation, readily accessible near the system.

1.7 Updated documentation

The most recent versions of the documents can be obtained at <https://www.kbr.de>

2. Safety Instructions

2.1 Safety instructions

-  Follow the operating instructions.
-  Keep the operating instructions with the device.
-  Ensure that the device is operated only in a perfect condition.
-  Never open the device.
-  When opening the battery compartment, disconnect the power supply.
-  Ensure that only qualified personnel operate the device.
-  Connect the device only as specified.
-  Ensure that the device is operated only in the original condition.
-  Connect the device only with recommended accessories.
-  Ensure that the device is not operated outside the design limits. (See the technical data)
-  Ensure that the original accessories are not operated outside the design limits.
-  For measurements in short circuit resistant systems, ensure that voltage taps with integrated fuses are used.
-  Do not use the device in environments where explosive gases, dust or fumes occur.
-  Clean the device only with commercially available cleaning agents.

 **DANGER!**

Danger to life due to electric shock!

If the device is used in a way not specified by the equipment producer, the device protection will be impaired.

 Observe safety instructions

2.2 Meaning of the symbols used on the device



Nature and source of the danger! Read the safety instructions inside the manual!



Voltage ground

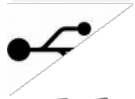

USB-interface



CE marking guarantees compliance with the European directives and regulations regarding EMC



The unit is fully protected by double or reinforced insulation.

IP65

6X = Protection against dust

Protection against water **X5** = Protection against water jets from any angle



AC voltage



DC voltage

CAT IV

Category IV

3. Scope of Delivery/Order Codes multilog 3

3.1 Scope of Delivery

- 0 multilog 3
- 0 User Manual
- 0 Case
- 0 3 red dolphin clips, 1 blue dolphin clip, 1 green dolphin clip
- 0 3 high-load fuses integrated in voltage leads
- 0 USB cable
- 0 2 voltage leads for integrated wide range power supply with 2 x 4 mm safety plugs and integrated high-load fuses

3.2 Order Codes

The multilog 3 is available in different versions:

1 multilog 3 basic

The device is suitable for performance analyses for energy audits according to ISO 50001, as a data logger for troubleshooting and for online measurements.

1 multilog 3 light

This version is equipped with manual trigger option for oscilloscope and ½ cycle RMS records. Standard evaluations according to EN50160, IEC61000-2-2/2-4 for public and industrial power systems are automatically generated.

1 multilog 3 expert

This version is additionally equipped with comprehensive trigger functions for oscilloscope and ½ cycle RMS records.



With a licence code, the multilog 3 can be upgraded, light or expert.

We take care of it

Performance			
multilog 3	basic	light	expert
Statistic EN50160/IEC 61000-2-2/IEC 61000-2-4		x	x
PQ-events		x	x
Recording free interval (1sec...30min):		x	
Voltage: min. max. average	x	x	x
Current: min. max. average	x	x	x
Power: P, Q, S, PF, cos phi, sin phi, tan phi	x	x	x
Distortion power D	x	x	x
Energy: P, Q, P+, P-, Q+, Q-	x	x	x
Flicker according IEC61000-4-15 (Pst, Plt, Pinst)		x	x
Unbalanced voltage, current	x	x	x
Voltage harmonics		up to 50 th	up to 50 th
Voltage harmonics extreme values 200ms			x
Current harmonics		up to 50 th	up to 50 th
Current harmonics extreme values 200ms			x
Phase angle of current and voltage harmonics			x
Real, apparent and reactive power of harmonics			x
THD voltage, current; PWhd, PHC	x	x	x
Inter harmonics – voltage, current			DC to 10 kHz
Ripple control signal		x	x
Frequency: min. max. average	x	x	
Power / Energy Interval			
10/15/30 min interval – Voltage, P, Q, S, D, cos phi, sin phi ...	x	x	x
Online mode:			
Oscilloscope recorder	x	x	x
½ cycle RMS recorder		x	x
Voltage & current harmonics, inter harmonics		x	x
FFT spectrum (U, I)			DC to 10kHz
Direction of harmonics			x
Trigger options:			
½ cycle RMS recorder (U, I, P, Q, S, frequency)			x
Oscilloscope recorder (U, I)			x
Phase shift trigger, wave shape trigger			x
Interval-trigger			x
Automatic trigger			x



With a licence code, the multilog 3 can be upgraded from lower version to a higher version.

3.3 Technical data

multilog 3 (4U/4I)	
4 voltage inputs (AC/DC):	L1, L2, L3, N, E;
Maximum input voltage:	DC 848V = AC 1039V L-L AC 600V L-E 1.2 MΩ impedance
4 current inputs (AC/DC):	1000 mV input for mini clamp and 330 mV for Rogowski coils 15 kΩ impedance
Sampling rate:	20.48 kHz at 50 Hz/60 Hz
Automatic synchronization to fundamental oscillation:	45 Hz to 65 Hz
Measurement intervals:	Freely adjustable from 1 s to 30 min + 10/15/30 min
Data memory:	1 GB
Interfaces:	WLAN/WiFi, USB
Time synchronization:	NTP with WLAN
Dimensions:	220 x 110 x 40 mm
Mass:	1 kg
Degree of protection:	IP65
IEC 61000-4-30 Ed.3:	Class A
Accuracy:	< 0,1 %
Insulation class:	CAT IV / 600 V
Insulation test	Impulse voltage = 12,8 kV 5 sec = 7,4 kV rms
A/D converter:	16 Bit
Climate/temperature proof:	Function: -20°45°C Storage: -30°80°C
Power supply:	AC 100 V...440 V ~ OVC IV 50/60Hz; 180..80mA oder DC 100 V...250 V =; 105...35mA 440V CAT IV

EMC

CE- conformity

- 0 Interference immunity
 - EN 61326
 - EN 61000-6-2
 - 0 Emitted interference
 - EN 61326
- EN 61000-6-4

ESD IEC 61000-4-2 IEC 60 255-22-2	8 kV / 16 kV
Electromagnetic fields IEC 61000-4-3 IEC 60 255-22-3	10 V/m
Burst IEC 61000-4-4 IEC 60 255-22-4	4 kV/2 kV
Surge IEC 61000-4-5	2 kV/1 kV
HF conducted disturbances — IEC 61000-4-6	10 V, 150 kHz ... 80 MHz
Voltage dips — IEC 61000-4-11	100 % 1 min
0 Housing at a distance of 10 m	30...230 MHz, 40 dB 230...1000 MHz, 47 dB
0 AC supply connection at a distance of 10 m	0.15. 0.5 MHz, 79 dB 0.5. 5 MHz, 73 dB 5...30 MHz, 73 dB

We take care of it

Measurement quantity	Error limits according IEC 61000-4-30, Class A
Fundamental oscillation: r.m.s.	$\pm 0.1\%$ of U_{din} over 10% ~ 150% of U_{din}
Fundamental oscillation: Phase	$\pm 0.15^\circ$ over 50% ~ 150% of U_{din} over $f_{nom} \pm 15\%$
2nd ... 50th harmonic	$\pm 5\%$ of display over $U_m = 1\% \sim 16\%$ of U_{din} $\pm 0.05\%$ of U_{din} over $U_m < 1\%$ of U_{din}
2nd 49th interharmonic	$\pm 5\%$ of display over $U_m = 1\% \sim 16\%$ of U_{din} $\pm 0.05\%$ of U_{din} over $U_m < 1\%$ of U_{din}
Frequency	$\pm 5\text{mHz}$ over $f_{nom} \pm 15\%$ ($f_{nom} = 50\text{ Hz} / 60\text{ Hz}$)
Flicker, Pst, Plt	$\pm 5\%$ of display over 0.02% ~ 20% of $\Delta U / U$
Dip residual voltage	$\pm 0.2\%$ of U_{din} over 10% ~ 100% of U_{din}
Dip duration	$\pm 20\text{ ms}$ over 10% ~ 100% of U_{din}
Swell residual voltage	$\pm 0.2\%$ of U_{din} over 100% ~ 150% of U_{din}
Swell duration	$\pm 20\text{ ms}$ over 100% ~ 150% of U_{din}
Interruption duration	$\pm 20\text{ ms}$ over 1% ~ 100% of U_{din}
Voltage asymmetry	$\pm 0.15\%$ over 1% ~ 5% of display
Ripple control voltage	$\pm 5\%$ of display over $U_m = 3\% \sim 15\%$ of U_{din} $\pm 0.15\%$ of U_{din} over $U_m = 1\% \sim 3\%$ of U_{din}

4. Accessories for current measurement

- Standard accessories are automatically recognized by the meter.
- The conversion factor is automatically adjusted for the connected accessory.

4.1.1 Rogowski current clamps

- 1 Rogowski current clamp 4~: Up to 3000 A
- 1 Rogowski current clamp 4~: Up to 6000 A

Model	Up to 3000 A Pro Flex 3000 4~	Up to 6000 A Pro Flex 6000 4~
Current range	3,000 A AC RMS	6,000 A AC RMS
Measurement range	0-3300 A AC RMS	0-6,600 A AC RMS
Output voltage	85 mV / 1000 A	42.5 mV / 1000 A
Frequency range	10 Hz to 20 kHz	10 Hz to 20 kHz
Isolation voltage type	600 V AC / DC CAT IV	600 V AC / DC CAT IV
Accuracy (20 °; 50 Hz)	<50 A/0.1 % of the full scale value 50-3000 A/1.5 % of the measured value	<100 A/0.1 % of the full scale value 100-6000 A/1.5 % of the measured value
Angle error (45-65 Hz)	<50 A/2.5 ° 50-3000 A/1 °	<100 A/2.5 ° 100-6000 A/1 °
Position accuracy	<50 A/0.2 % of the full scale value 50-3000 A/1.5% of the measured value	<100 A/0.1 % of the full scale value 100-6000 A/1.5% of the measured value
Long Rogowski coils	610 mm	910mm
Diameter clamp head	9,9mm	9,9mm

- 1 Mini- Rogowski current clamp 4~: Ident-No. Up to 500 A

Current range: 500A RMS; Accuracy: 1%
 Rogowski clamp length = 220mm;
 Diameter = 70mm; Rogowski clamp head = 6mm
 Frequency range: 10Hz to 50kHz

4.1.2 Current clamps

The MU-metal clamp is especially applicable for small current measurements on secondary transformers in medium- and high-voltage networks. High accuracy and small angle errors are combined.

1 Mu-Metal Mini-Current clamps 3~: Up to 20 A

Current range: 10mA to 20A

Frequency range: 40Hz to 20kHz

1 Mu-Metal Mini-Current clamps 4~: Up to 20/200 A

Up to 20/200 A

Measurement range	20 A measurement range	200A measurement range
Current range	20 A AC RMS	200 A AC RMS
Measurement range	100 mA to 20 A RMS	1 A to 200 A RMS
Output voltage	10 mV/A	1 mV/A
Frequency range	40 Hz to 20 kHz	40 Hz to 20 kHz
Isolation voltage type	600 V AC	600 V AC
Accuracy	100 mA- 10 A/1.5 % of the measured value 10-20 A/1 % of the measured value >20 A/1% of the measured value	10-40 A/<2 % of the measured value 40-100 A/<1.5 % of the measured value 100-200 A/<1 % of the measured value
Angle error	100 mA- 10 A/2 ° 10-20 A/2° >20 A/2°	10-40 A/<2 ° 40-100 A/<1.5 ° 100-200 A/<1 °



200 A Measurement range up to 20/200 A

👉 Adjustment of the power converter factor to x10. For the clamp with two ranges the automatic factor detection of the multilog 3 does not work for the second.

1 Mu-Metal Mini-Current clamp 0...5A 1~: Up to 5 A

Current range: 5mA to 5A AC RMS
 Frequency range: 40Hz to 20kHz
 Free current adapter set necessary

1 AC/DC Current clamp 1~: AC/DC up to 60/600 A

AC/DC hall sensor clamp. Set with power supply and 2 pcs. 4mm connectors
 Current range 60A/600A (two ranges)

AC/DC up to 60/600 A

Measurement range	AC/DC 60 A	AC/DC 600 A
Current range	60 A DC / 40A AC RMS	600 A DC / 400A AC RMS
Measurement range	200 mA to 60 A RMS	600 A RMS
Output voltage	10 mV/A	1 mV/A
Frequency range	DC to 10 kHz	DC to 10 kHz
Isolation voltage type		
Accuracy	0.5-40 A/<1.5 % +5 mV 40-60 A/1.5 %	0.5-100 A/<1.5 % +1 mV 100-400 A/<2 % 400-600 A(DC only)/<2.5 %
Angle error	10-20 A/<3 ° 20-40 A/<2.2 °	10-300 A/<2.2 ° 300-400 A/<1.5 °





600 A Measurement range (AC/DC)

👉 Adjustment of the power converter factor to x10

4.1.3 Accessories for current measurement

1 Free Adapter set for connecting 4 clamps:

Adapter set for connecting 4 clamps or shunt with 4mm connectors. 2m length

 CAUTION!	Damage to the device from external current clamps
	 Do not use clamps with A or mA output
	 Avoid input voltages at the current inputs greater than 30 V



Power conversion factor

Current conversion correction factor; the default is 1 A/10 mV

Example:

If you use a current clamp with a 500 A to 500 mV range, it is necessary to change the CT ratio in the setup of the device to "10x".

1 Current clamp cable extension:

Cable extension 5 m for current clamps or Rogowski coils.

1 Current-shunt 2A:

Measurement of AC- and DC-currents. Current range = 2A / 200mV output signal

5. Intended use

The product is exclusively designed for the measurement and evaluation of voltages and currents. The current inputs are mV-inputs.

- 👉 Observe safety instructions
- 👉 Ensure that the device is not operated above the rated data

6. Description

The Network Analyzer multilog 3 is suitable for analysis in low, medium and high-voltage networks. It meets all the requirements of the measurement equipment standard IEC61000-4-30 Ed. 3 class A.

Functions:

- Voltage quality measurements according to EN50160, IEC61000-2-2 and IEC61000-2-4 for low and medium voltage networks
- Fault recorder functions
- Load analyses; energy measurements
- Ripple control signal analysis

7. Hardware multilog 3

7.1 multilog 3 Hardware

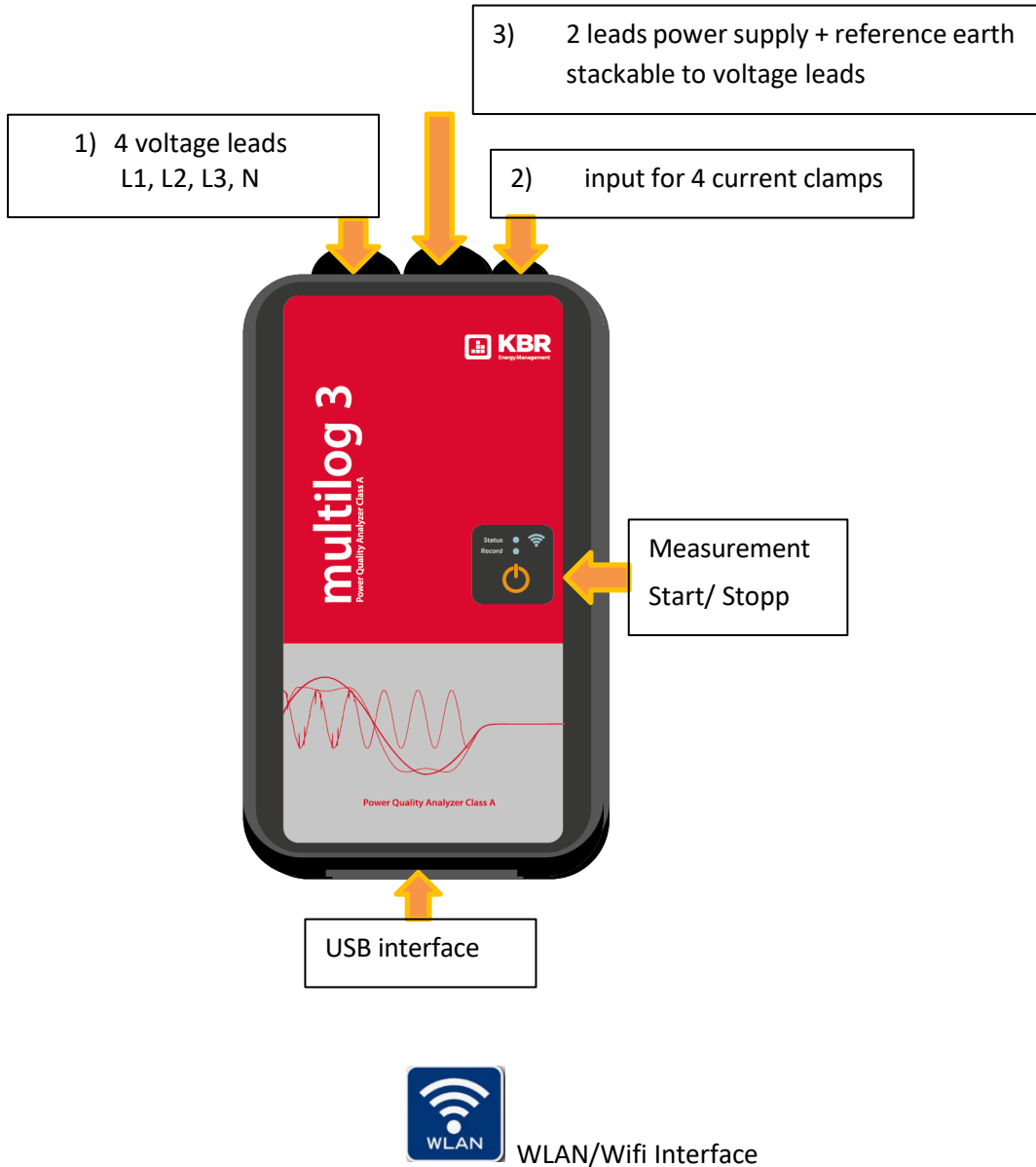

1) 5 voltage leads fix connected:

- L1 (red - L1)
- L2 (red - L2)
- L3 (red - L3)
- N (blue - N)
- Earth (green - E)

The housing cover can be opened by the user.
Here is a battery pack.
This can be exchanged by the user if necessary.

⚠ DANGER!	<p>Danger to life due to electric shock!</p> <p>The maximum voltage of the reference earth (green) must not exceed the requirement of 600V against earth</p> <p>👉 Ensure that the device is not operated above the rated data</p>
------------------	--

⚠ CAUTION!	<p>Damage to measurement voltage with overvoltage</p> <p>👉 Connect device to maximum DC voltage of 565V AC / 800V DC L-N.</p> <p>👉 Connect device to maximum AC voltage of 980V AC / 1380V DC L-L.</p>
-------------------	---

2) Current clamp connection (Amphenol plug 7-pole)

3) The multilog 3 is equipped with an internal extremely robust wide-range power supply. The power supply is designed for the high immunity of 300V CAT IV and complies with the protection class IP65.

The PQ box can be supplied with energy directly at the measuring point via this adapter and does not require a separate socket.

The following voltage ranges for the mains supply are possible: 88 V ... 500 V AC or 100V ... 300V DC

High-voltage fuses are installed in both measuring lines. These can be exchanged by the user.

⚠ CAUTION!	<p>Damage to power supply due to under- or overvoltage</p> <p>👉 Only power the device between 88V and 500V AC.</p> <p>👉 Only supply power between 100 and 300 V DC.</p> <p>👉 Do not supply the device directly from strongly disturbed voltages. (eg. at the frequency inverter output / Caution high clock frequencies can destroy the internal power supply)</p>
-------------------	---

⚠ DANGER!	<p>Danger to life due to electric shock!</p> <p>Only fuse 6.3mm x 32mm, 3 A F, with a breaking capacity of 50kA/600V may be used in the fuse carrier. Only fuses with the identical data may be used.</p> <p>👉 Make sure that the fuses used comply with the specifications.</p>
------------------	---

Front panel picture – keypad



1 LED display

Measurements are started and stopped via a "Start / Stop" button. If a recording has been started, this will be indicated by a flashing recorder LED.

LED Status	
0 Off	Device turned off.
0 Continuous green	Ready for Push-Button.
0 Continuous orange	Command processing.

LED Record	
0 Off	Messung nicht gestartet.
0 Flashing green	Recorder running.
0 Continuous green	Memory full. Recorder is stopped!

WLAN Status	
0 Off	Device is ready for connection
0 Continuous green	multilog 3 is connected to a device via WLAN.

Many measurements can be recorded one after the other without having to read the instrument beforehand. A glowing WLAN icon indicates if this interface is active and accessible.

7.2 Accumulator

The multilog 3 is equipped with a lithium-ion battery and intelligent charging electronic. The aim is to achieve a long battery life time. At 80% capacity, the PQ-Box can run approximately 2 hours without mains supply.

The Li-ion battery is first charged to 100% when the threshold (75%) is reached. This has a very positive effect on the total life time of the batteries.

Aging: At high temperature and the battery is full, the cell oxidation developed particularly rapidly. This condition may occur, f. e. in notebooks when the battery is fully charged and at the same time, the device is in operation. The optimal charge level is between 50% and 80% during storage.

- Charging stops when exceeding a battery temperature of 50 ° C
- Start charging only when the battery temperature is less than 45 ° C
- Warning Battery capacity below 7%
- multilog 3 shutdown when battery capacity <5%



We recommend storing the battery of the PQ-Box at 15 ° C with a charge of 60% - this is a compromise between accelerated aging and self-discharge. The battery of the multilog 3 should be recharged to approximately 55-75% every six months, due to the natural self-discharge, in order to ensure a long-term service life.

8. Network connection multilog 3

8.1.1 Direct connection to a 3-phase low voltage network

Connection in a 3-phase 4-wire AC network

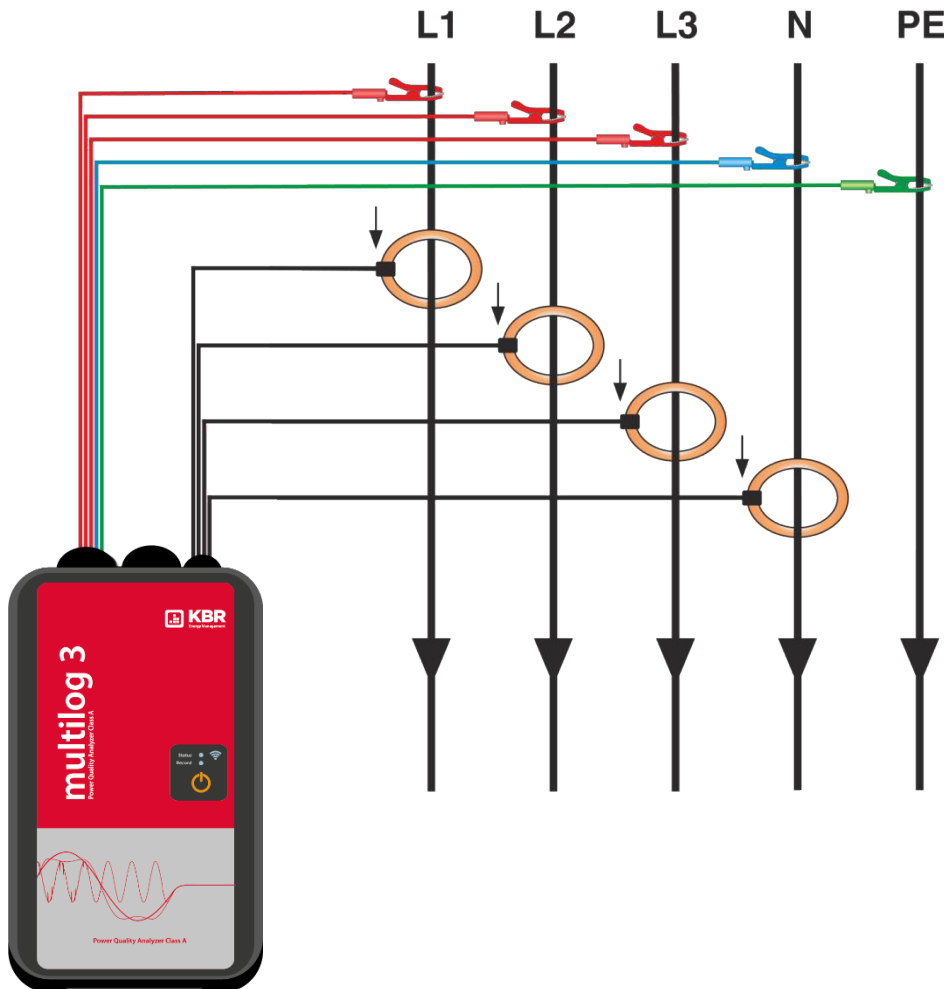

Voltage connection

- 👉 Ensure that voltage measurement cable PE is connected for every measurement.
- 👉 If no PE connection is available, connect E and N together.
- 👉 Ensure that switching (4-wire) is selected. (Setting via display or software)

8.2 Connection to a single-phase low voltage network

Connection for single-phase measurements

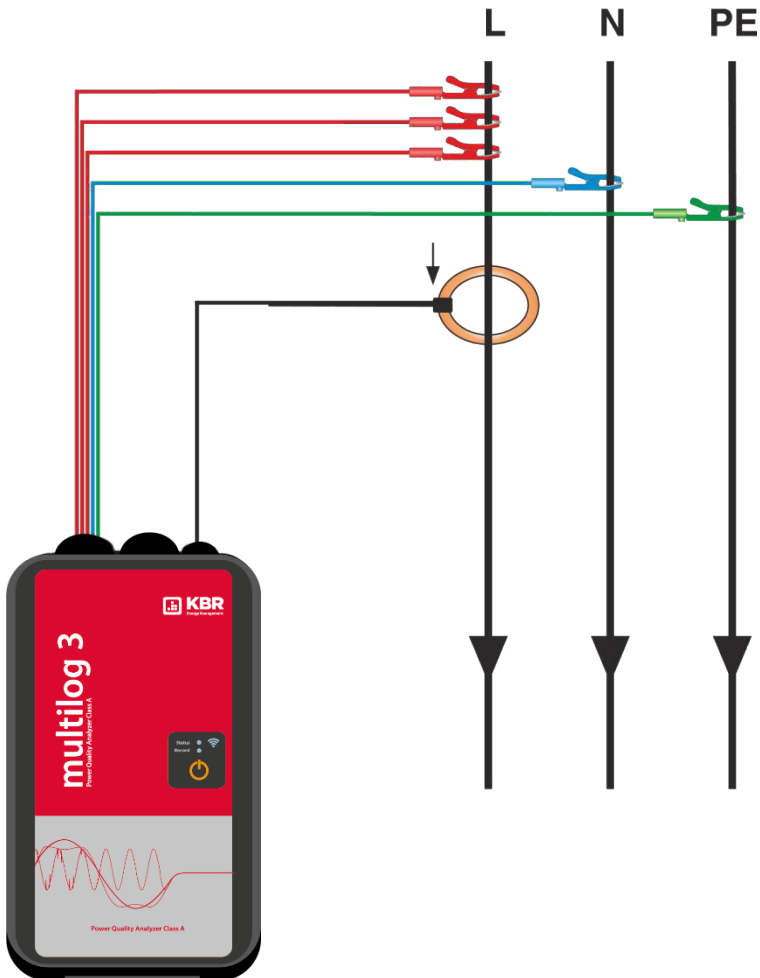

Voltage connection

- 👉 Ensure that voltage measurement cable E is connected for every measurement.
- 👉 If no PE connection is available, connect E and N together.
- 👉 Ensure that switching “1-wire system” is selected. (Setting via multilog App or software)

1-wire System

- 👉 Not necessary to connect phases L2 and L3 for voltage and currents in single phase measurement.

8.3 Connection to an isolated IT network

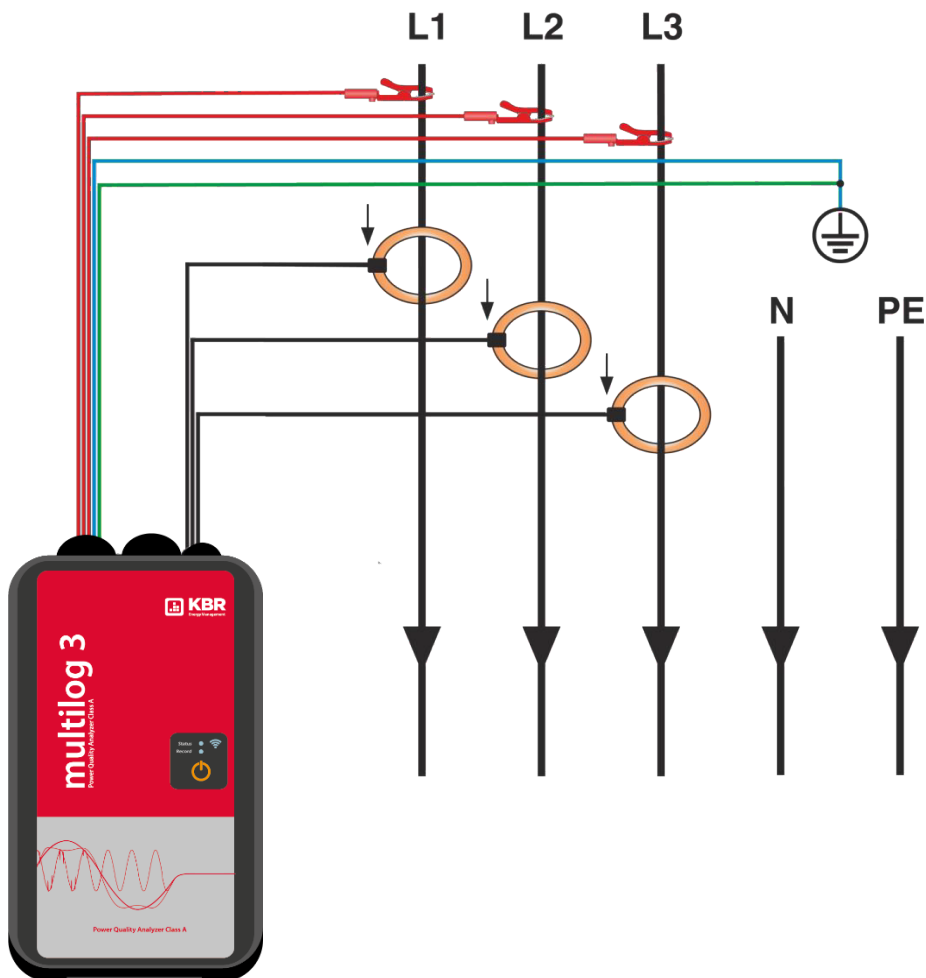

Connections

- ✎ Connect terminals E and N together and connect it to a ground potential.
- ✎ Ensure that switching (3-wire) is selected. (Setting via display or software)



The input impedance of a measuring input is 1,2 mega ohms.

If the high-resistance ground connection is not desired, it is also possible to interconnect the terminals E and N and to hang open. (No connection to any ground)

In 3-wire connection the 4th voltage channel and the 4th current channel will be calculated from the device. (Voltage Neutral to Ground and current of the star point)

8.4 Connection to secondary transformer

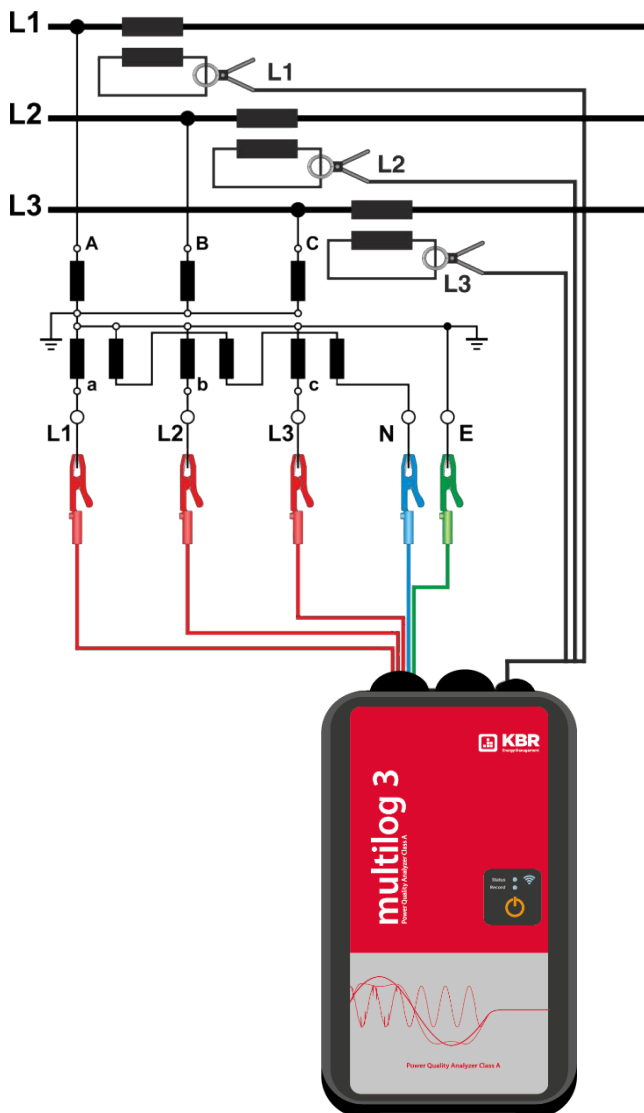

Connections

- 👉 Ensure that voltage measurement cable E is connected for every measurement.
- 👉 If no PE connection is available, connect E and N together.
- 👉 Ensure that switching (3-wire) is selected. (Setting via display or software)
- 👉 Set the voltage transformer ratio
- 👉 Enter the nominal conductor-conductor voltage
- 👉 Set the current transformer ratio



In 3-wire connection the 4th voltage channel and the 4th current channel will be calculated from the device. (Voltage Neutral to Ground and current of the star point)

8.5 Special circuit types

Configurations such as a V connection or aron connection can be parameterized.

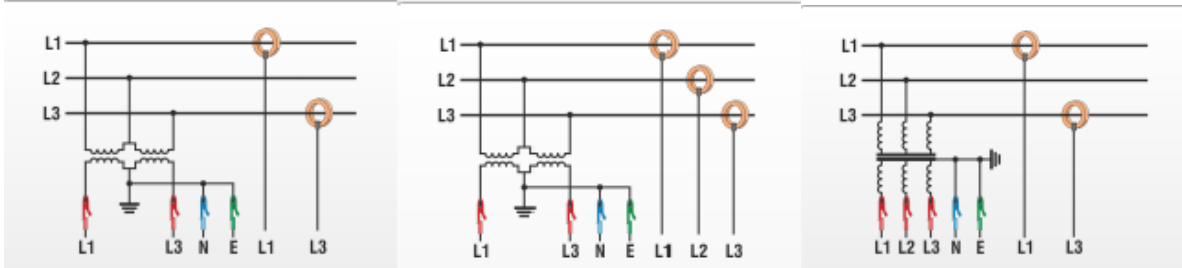

- V connection (parameterization through the evaluation software or device setup)
- Aron connection (parameterization through the evaluation software or device setup)

Isolated networks

Connections

- 👉 Connect voltage measurement conductors E and N to ground
- 👉 If this is not desired in the plant due to isolation monitoring, the E and N connections can be connected together and remain free without connection.
- 👉 Ensure that switching (3-wire) is selected.
- 👉 Set the voltage transformer ratio
- 👉 Enter the nominal conductor-conductor voltage
- 👉 Set the current transformer ratio

8.6 Starting a measurement



Press the  key to stop or start measuring.

- Recording "On" is indicated by green flashing light "Record"
- Recording stopped - LED record is off
- Memory multilog 3 full - LED record and status light permanently.
The recording is stopped.
- Attempt to start a measurement when the memory is full - Status LED changes to orange and Recorder LED flashes 2 x at a time.

8.7 Memory management

So that the recorder data does not fill the whole memory when a too sensitive or incorrect trigger level is set and thus the long-term recording is stopped, at the start of the measurement the multilog 3 reserves a maximum size of the free space for all fault records.

8.8 Delete device memory

Using a key combination at the start of the device, it is possible to completely erase the device memory.

- 0 Establish power supply to the multilog 3
- 0 Orange LED lights up
- 0 Now press the start button until orange LED and green LED flash together
- 0 If the start button is pressed within 3 seconds, the device memory will be erased and the multilog 3 will start. If the start button is not pressed, multilog 3 will start without clearing the memory.

8.9 Storage requirements for measurement data

Storage requirements for long-term measurement data:

Example multilog 3:

- 0 1 sec measurement interval generates approx. 30MB of data per hour
- 0 10 min measurement interval generates approx. 12 MB of data per week

Events and fault records have to be added to this amount of data. The amount of data is dependent on the occurrence of these events and the trigger settings of the measuring device.

8.10 WLAN multilog 3

The name of the WLAN router shown in the network for multilog 3 is:

„multilogAP_*serial number*“, for example: for „SSID: PQBox50AP_1804-204

For connection you have to enter the WPA2 Key on your PC or mobile phone. SSID and password for a WPA2 connection can be found on the nameplate of the network analyzer (Example: for „SSID: PQBox50AP_1804-204“ the password would be „1804-204“).



The WLAN IP address of the PQ-Box 50 is pre-set to 172.168.2.4 and cannot be parameterized

Older devices with a serial number lower than 2302-xxx have the IP address 192.168.2.4

9. multilog App



Via an app for Android and IOS operating systems, all PQ-Boxes / multilog 3 with integrated WLAN/Wifi interface can be operated wirelessly. The app is available for free download in the Apple App Store as well as in the Google Play Store.

A variety of online screens are available. All measuring devices can also be easily parameterized, e.g. via a smartphone. A detailed parameterization of the multilog 3 (trigger limits, ripple control signal analysis, ...) is only possible via the WinPQ mobil software.

9.1 Connection to multilog 3

The multilog 3 acts as a WLAN router. SSID and password for a WPA2 connection can be found on the nameplate of the network analyzer (Example: for „SSID: PQBox50AP_1804-204“ the password would be „1804-204“).

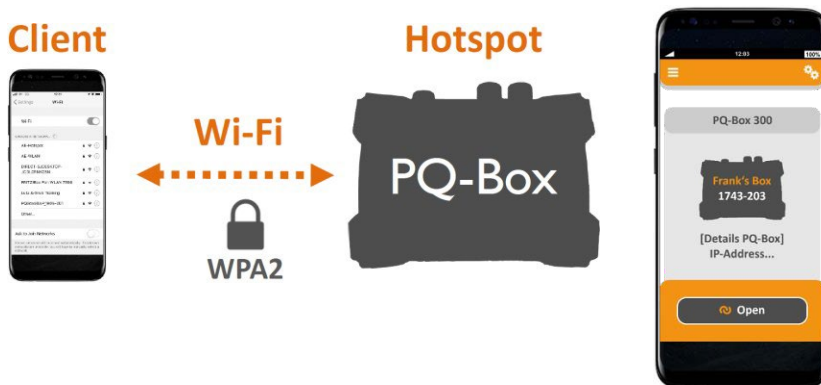

If the multilog 3 is already connected to a device via WLAN, the WLAN symbol lights up green. Only one device (mobile phone or notebook) can connect to the multilog 3 at a time.

10. Maintenance/Cleaning

This unit is maintenance-free for customers.



Exceptions are the battery pack and micro-SD card, which can be accessed via the rear panel.

The fuses are in the voltage leads.

- 0 Remove the rubber protective cover,
- 0 open the housing cover by unscrewing the 4 screws on the back.

Spare parts no.

0	Replacement battery pack
0	Fuse for voltage leads; 500 mA (FF) 50 kA AC/DC; 600 V 6,3 mm x 32 mm

 DANGER!	Danger to life due to electric shock! <ul style="list-style-type: none"> Do not open the unit. Maintenance of the equipment can only be carried out by KBR GmbH.
--	---

For service, contact KBR GmbH.

Service address:

A. KBR GmbH
Am Kiefernschlag 7
D-91126 Schwabach

11. Calibration

We recommend a calibration interval of three years for the network analyzer multilog 3 to maintain the accuracy of GEFOR-made-IEC61000-4-30 Class A instruments.

12. Disposal

To dispose of the device and its accessories, send all components to KBR GmbH.

13. Product Warranty

- 0 KBR GmbH guarantees that this product will remain free of defects in material and workmanship for a period of three years from the date of purchase.
- 0 For accessories like current clamps and the battery the period is one year.
- 0 This warranty does not cover damage caused by accident, misuse or abnormal operating conditions.

To obtain service during the warranty period, please contact KBR GmbH in Schwabach.

KBR GmbH

Am Kiefernschlag 7
D-91126 Schwabach

Tel.: 09122 / 6373-0
Fax: 09122 / 6373-83

E-Mail info@kbr.de
Internet: www.kbr.de

28230_EDEBDA0324-1824-1_EN_multilog 3_Hardware